

# Mubea Disc Springs

Manual



**Mubea**  
engineering for mobility

# Contents

<b>Mubea Group of Companies</b>	Mubea worldwide ... 9 Mubea disc springs ... 13	<b>Chapter 1</b>
<b>Mubea Disc Springs</b>	2.1 Disc spring product overview ... 22 2.2 Application examples ... 26 2.3 Production ... 30	<b>Chapter 2</b>
<b>Design and Theory</b>	3.1 Design ... 38 3.1.1 Quick selection guide ... 38 3.1.2 Mubea's Calculation Program ... 40 3.2 Disc spring theory... 40 3.2.1 Properties and construction ... 40 3.2.2 Classification according to DIN 2093 ... 42 3.2.3 Evaluation of individual disc springs ... 43 Disc springs without contact surfaces with force application per DIN ... 44 Disc springs without contact surfaces with force application through shortened lever arms ... 45 Disc springs with contact surfaces ... 46 Special Cases ... 47 3.2.4 Disc spring combinations ... 48 Spring stack design ... 48 Spring stack design guidelines ... 49 Spring stack guides ... 49 3.2.5 Calculating allowable load stresses ... 52 3.2.6 Relaxation and creep ... 56 3.2.7 Friction ... 57 Friction for an individual disc spring ... 57 Friction in stacks of disc springs arranged in parallel ... 58 Friction in stacks of disc springs in series ... 59 3.3 Symbols, signs, denominations and units ... 60	<b>Chapter 3</b>
<b>Tolerances</b>	4.1 General tolerances ... 66 4.2 Load testing of disc springs ... 67 Individual disc spring ... 67 Disc spring stacks in series ... 67	<b>Chapter 4</b>
<b>Materials and Corrosion Protection</b>	5.1 Materials ... 72 5.1.1 Standard materials ... 76 5.1.2 Corrosion-resistant materials ... 76 5.1.3 Thermally stable materials ... 77 5.1.4 Antimagnetic and corrosion-resistant materials ... 77 5.1.5 High temperature materials ... 78 5.2 Corrosion protection ... 78 5.2.1 Phosphate coatings ... 78 5.2.2 Galvanising ... 79 5.2.3 Mechanical zinc plating ... 79 5.2.4 Delta Tone/Delta Seal coating ... 79 5.2.5 Dacromet coating ... 79 5.2.6 Chemical nickel plating ... 80	<b>Chapter 5</b>
<b>Product Range and Characteristics Graphs</b>	6.1 The Mubea disc spring product lines ... 83 6.2 Tables... 84 6.3 Diagrams ... 104	<b>Chapter 6</b>



# Mubea Group of Companies









Engineering for mobility: As an international partner of the automobile industry, Mubea develops and manufactures high-quality disc springs, suspension springs, stabiliser bars, engine valve springs, hose clamps, belt tensioning systems and other highly-stressed components.

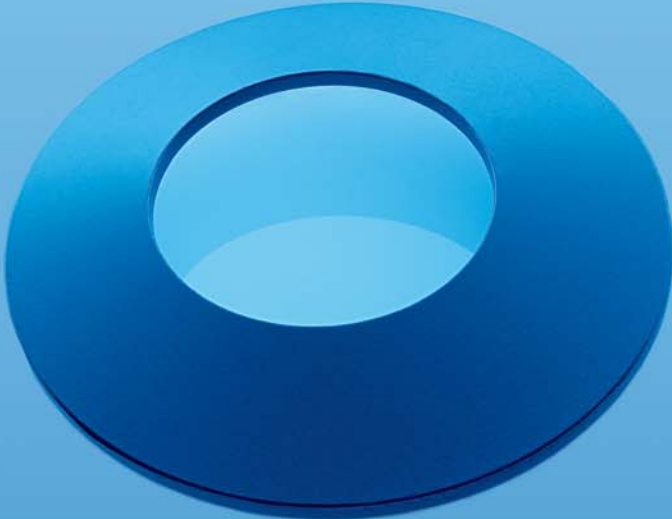



## **Mubea worldwide**

**Muhr und Bender KG, Attendorn (Germany)**

**Muhr und Bender KG, Weitefeld (Germany)**

**Mubea Fahrwerksfedern GmbH, Attendorn (Germany)**

**Mubea Fahrwerksfedern GmbH, Weißensee (Germany)**

**Mubea Motorkomponenten GmbH, Attendorn (Germany)**

**Mubea Motorkomponenten GmbH, Hildburghausen (Germany)**

**Mubea Motorkomponenten GmbH, Thale (Germany)**

**Mubea Tellerfedern und Spannelemente GmbH, Daaden (Germany)**

**Muhr und Bender Maschinenbau GmbH, Attendorn (Germany)**

**Mubea spol. s r.o., Zebrák (Czech Republic)**

**Mubea-HZP s.r.o., Prostejov (Czech Republic)**

**Mubea Engineering AG, Heiden (Switzerland)**

**Mubea Fabbrica Molle SA, Bedano (Switzerland)**

**Mubea Chuo SA, Heiden (Switzerland)**

**Mubea UK Ltd., Northampton (Great Britain)**

**Mubea France S.A.S.U., Paris (France)**

**Mubea France S.A.S.U., Etablissement de Menchhoffen, Menchhoffen (France)**

**MCS Mubea Chuo SA, Bruxelles (Belgium)**

**Mubea Italia s.r.l., Stabilimento di Melfi, Melfi (Italy)**

**Mubea Iberia S.A., Agreda (Spain)**

**Mubea Inc., Florence, Kentucky (USA)**

**Mubea Inc., Elsmere, Kentucky (USA)**

**IT Spring Wire LLC, Florence, Kentucky (USA)**

**CMSC Chuo Mubea Suspension Components Company Inc., Florence, Kentucky (USA)**

**Mubea de Mexico S. de R.L. de C.V., Saltillo (Mexico)**

**Mubea do Brasil Ltda., Taubaté (Brazil)**

**IT Spring Wire do Brasil Ltda., Taubaté (Brazil)**

**Mubea Korea Co., Ltd., Seoul (South Korea)**

**Mubea Automotive Components Co., Ltd., Taicang (China)**

**Mubea Japan Co., Ltd., Kobe (Japan)**

**Mubea Japan Co., Ltd., Tokyo (Japan)**

**Technical collaboration (South Africa)**

# Mubea Disc Springs

The name Mubea is internationally synonymous with spring technology of the highest standard. The quality of our disc springs and roll pins compare with those produced anywhere in the world. Our products are manufactured at our facility in Daaden, Germany – with know-how, modern quality control and decades of experience.

**Daaden**



## Mubea Dics Springs and Roll Pins



Mubea has specialised in the production of high quality disc springs for over 40 years. Because of their versatility, disc springs are used extensively in a variety of applications, from safety valve systems 3000 m under the sea to satellites in space. We also specialise in the production of related components including complex precision fine blanked parts and high-quality roll pins.

Mubea stocks disc springs manufactured per the requirements of DIN 2093 as well as our own internal standards. Mubea is capable of producing conventional disc springs with outside diameters up to 800 mm, internally and externally slotted disc springs, and wave springs. All of our products are manufactured in house, starting with the production of the blank material in our own cold-rolling mill. Furthermore, all tooling is designed, manufactured, and maintained in house. In addition to 50 CrV 4 (SAE 6150), Mubea stocks a variety of antimagnetic, corrosion resistant, and high/low temperature materials for special applications. This allows us to respond quickly to requests for disc springs of non standard size and/or materials. Mubea disc springs are shot-peened as part of our standard manufacturing process. This is especially advantageous in dynamic applications requiring a long fatigue life. We maintain well equipped laboratories capable of performing a wide variety of tests as required by our customers. Our team of highly qualified engineers is dedicated to finding the optimal solution for every spring application through the use of new technologies, innovative approaches, and creativity. We look forward to working with you.



Tel: +49/27 43 806 0  
Fax: +49/27 43 806 188  
[www.mubea-tellerfedern.de](http://www.mubea-tellerfedern.de)  
E-Mail: [tellerfedern@mubea.com](mailto:tellerfedern@mubea.com)





# Mubea Disc Springs







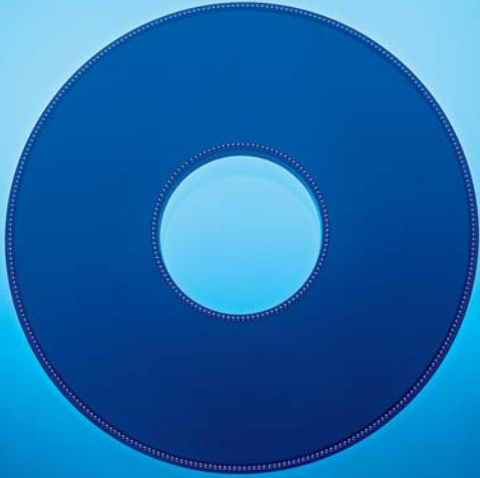



- 2.1 Disc spring product overview
- 2.2 Application examples
- 2.3 Production

# Disc Spring Product Overview

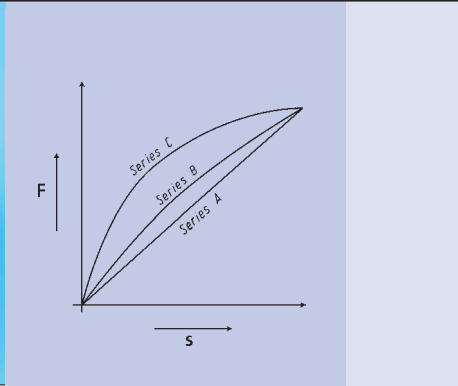
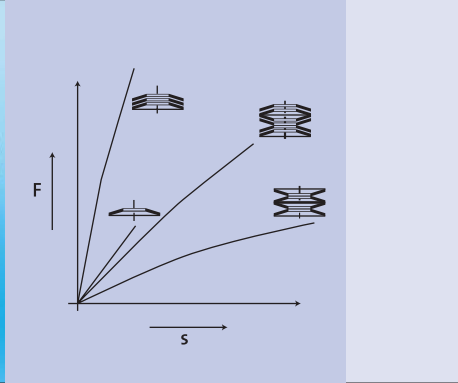

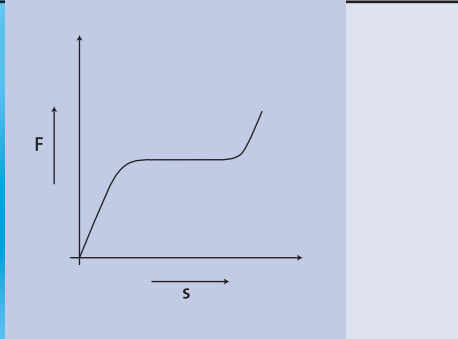
# Mubea Disc Springs

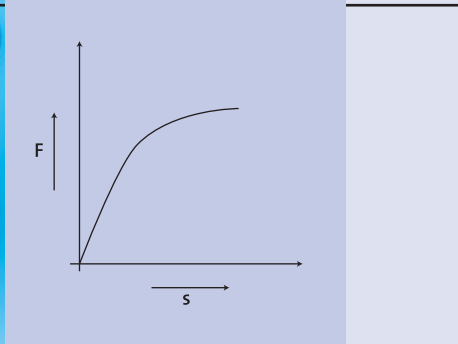
## 2.1 Disc Spring Product Overview

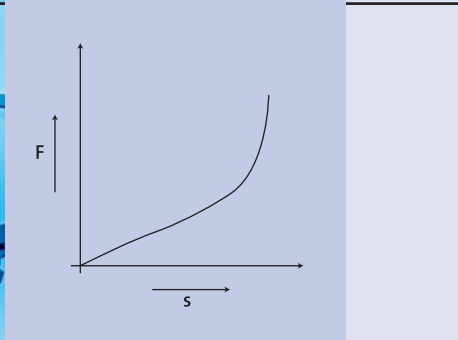
Spring Type	Appearance	Spring characteristics
<p>CONVENTIONAL DISC SPRINGS</p>	 	 
<p>SLOTTED DISC SPRINGS <sup>1)</sup></p>		
<p>SPECIAL SPRINGS <sup>1)</sup></p>		
<p>WAVE SPRINGS <sup>1)</sup></p>		

## Typical applications

- | Boiler suspension systems in power plants
- | Safety valves
- | Overload protection in electric transformers
- | Couplings
- | Aerial cable cars
- | Machine tool clamping components
- | Safety brakes for lifts and elevators
- | Brakes for construction and railway vehicles
- | Backlash compensation for ball bearings
- | Vibration isolation, etc.

- | Automatic transmissions
- | Overload clutches
- | Clutches, etc.

- | Adapted to the specific installation requirements in
  - | Clutches
  - | Gearboxes, transmissions, etc.

- | Automatic transmissions
- | Backlash compensation, etc

<sup>1)</sup> custom designed parts



### Conventional disc springs

- | Disc springs to DIN 2093 (Group 1, Group 2, Group 3 ...)
- | Disc springs to Mubea Factory Standards or other as required
- | Size range: outside diameter 8.0 mm to 800 mm
- | Materials to DIN 2093 (DIN 17 221, DIN 17 222) and special materials (*Section 5.1*)
- | Disc springs with a thickness of 0.5 mm and greater are shot-peened to improve fatigue life
- | Standard corrosion protection is phosphating and oiling. (*Other coatings are available as noted in Section 5.2*)



### Disc spring stacks

On request, Mubea can deliver disc springs pre-assembled in stacks or on a guiding device.

Advantages include:

- | Ability to provide stack specific load-deflection diagrams (our load testing machines can measure loads up to 1000 kN)
- | Small load tolerances possible
- | 100% load testing can be used to verify proper stacking
- | Assembly is more efficient with pre-assembled stacks





## **Internally or externally slotted disc springs**

- | Size range: outside diameter 20 to 300 mm
- | Slotted disc springs are typically developed in close collaboration with customers for specific applications
- | Special production processes are used to maintain extremely tight load tolerances and to achieve the maximum possible fatigue life.



## **Special springs**

As necessary, Mubea will work with the customer to develop special springs to meet the requirements of specific applications.



## **Wave springs**

Mubea produces wave springs with outside diameters ranging from 20 mm to 300 mm. Wave springs are often used to improve shift quality in automatic transmissions. Wave springs are designed per the specific requirements of each customer.

## 2.2 Application examples

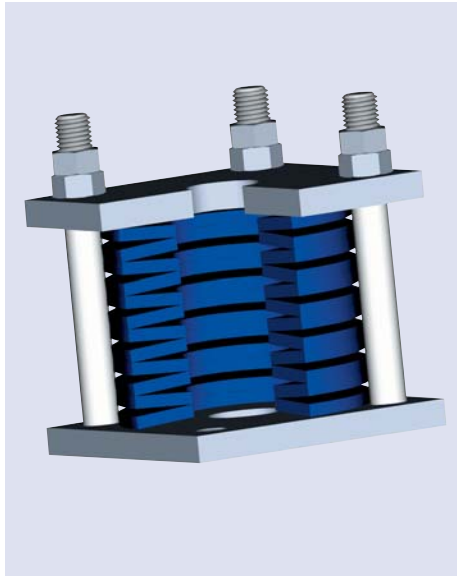
**Pre-assembled spring stacks**

Plant construction, power station construction, machine construction

Spring stacks are used for boiler suspension systems. The spring assemblies compensate for localised deflections in the bearing surface and thus guarantee an even lowering of the boiler with load fluctuations due to thermal expansion.

**Valves**

Plant construction, machine construction, chemical industry

In quick-action stop valves the disc spring stack is hydraulically preloaded when in the open position. If a failure occurs, the hydraulic pressure drops and the disc spring stack is released, closing the valve and thus interrupting the flow. Often ball-centered disc spring stacks are used for this purpose.

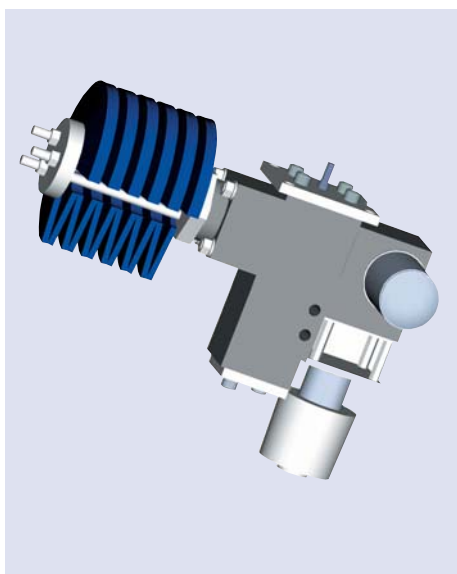
**Energy storage for safety systems**

Circuit breakers, machine construction

In hydraulic spring mechanisms, energy storage is often achieved by means of a disc spring stack.

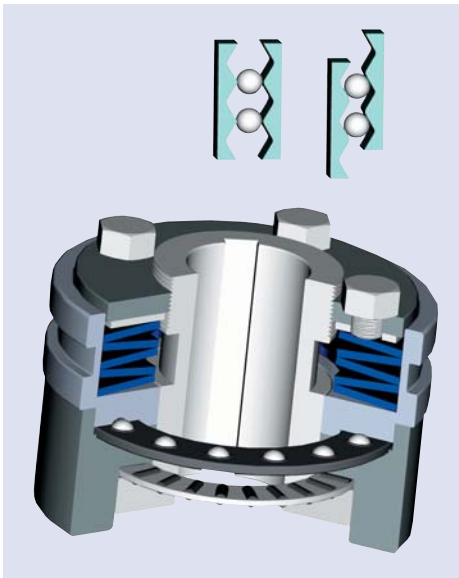

## Overload clutches

Plant construction, machine construction, motor vehicle construction

In overload clutches, disc springs provide the load required to maintain sufficient friction to transmit the torque. The load level can be regulated with adjuster nuts. If overload occurs the transmission of torque is interrupted.

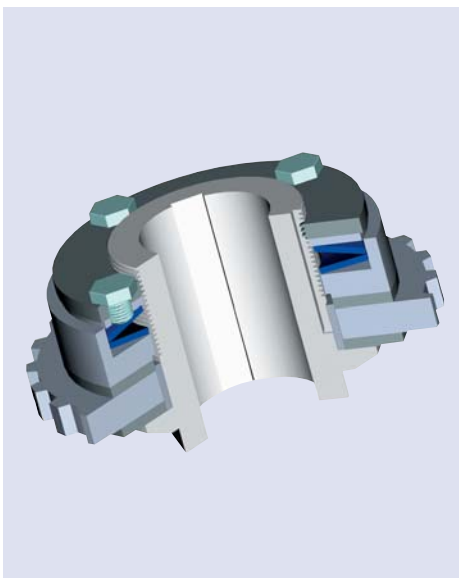

## Slip clutches

Plant construction, machine construction, motor vehicle construction

In slip clutches the disc spring provides a defined axial pressure on the friction linings. Wear on the friction linings over the life of the clutch is compensated for by the disc spring, thereby maintaining a constant torque level. Slotted disc springs with a flat load curve are especially well suited to this type of application.

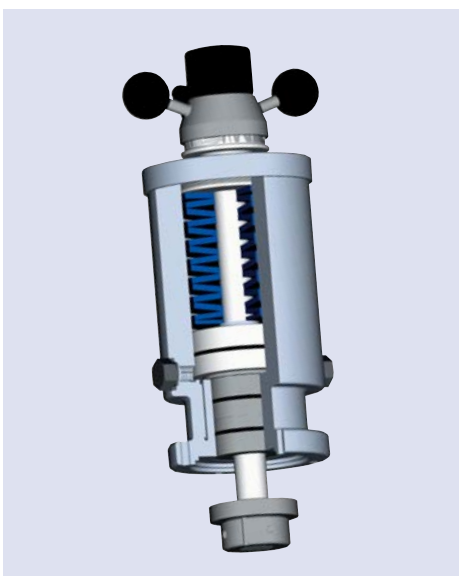

## Piston return springs

Off road and automotive transmissions

The disc spring ensures that the hydraulically actuated piston returns to its original position after the load on the coupling is released. Tolerances and wear on the coupling components are compensated for by the horizontal characteristic of the load curve in the working range of the disc spring. This results in consistent shift quality.

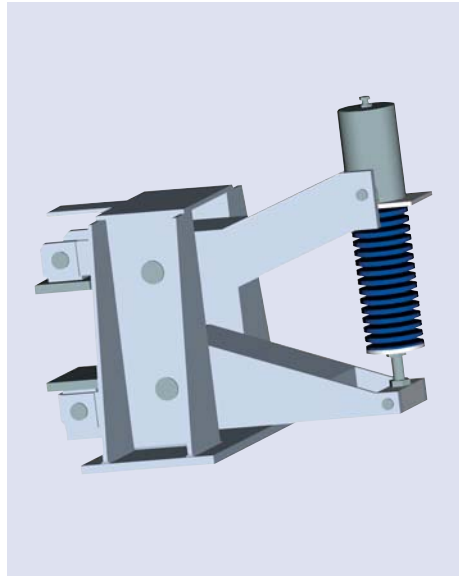

### Spring-actuated brakes (Fail safe brakes)

Plant construction, machine construction, motor vehicle construction

The braking load is generated by the disc springs when the hydraulic pressure is reduced to a predetermined level.



### Tool clamping components

Machine construction, toolmaking

In tool clamping components, the function of the disc spring stack is to hold the tool securely in the tapered holder.

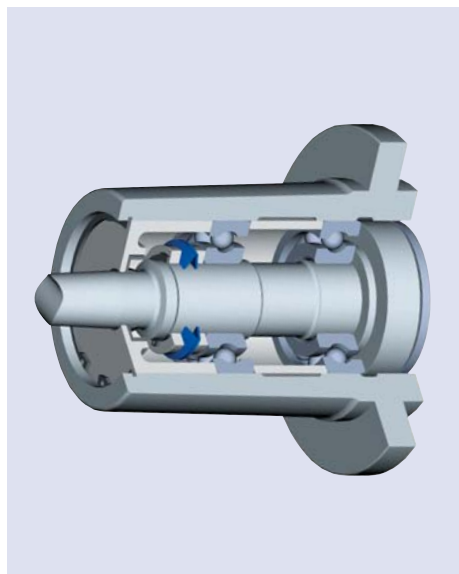

### Backlash compensation

Plant and machine construction

Disc springs are often used to compensate for geometric tolerances in component assemblies.

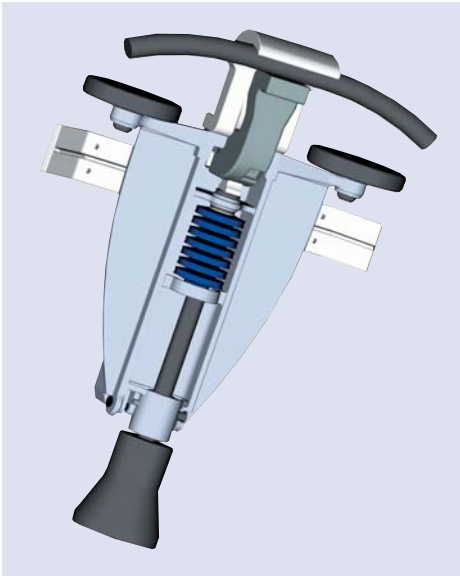

## Cableway grip

### Plant construction

On cableways a disc spring stack generates a friction lock between the cable grip and wire cable. Depending on the type of grip, the load can be static or dynamic.

## 2.3 Production

Mubea sets high internal standards to ensure superior quality at a reasonable cost by using innovative and extremely efficient production methods, starting with the production of the raw material.

The majority of strip material used is produced to very tight tolerances. Depending on the disc thickness, the disc blanks are manufactured by stamping (Group 1), fine blanking (Group 2) or plasma arc/flame cutting (Group 3). Disc springs of greater material thickness are machined all over to remove surface imperfections. Depending on the application, disc springs can be heat-treated with either a martempering or austempering process to extremely tight hardness tolerances. Subsequent shot-peening improves the fatigue life of the springs. Our standard corrosion protection, phosphating and oiling, is done in our own facility. Complete monitoring of the various production stages guarantees the high quality of Mubea disc springs. Mubea's quality system is certified to DIN EN 9001, VDA 61 and QS 9000 and to the environmental guideline DIN EN ISO 14000.



Development



Tool making

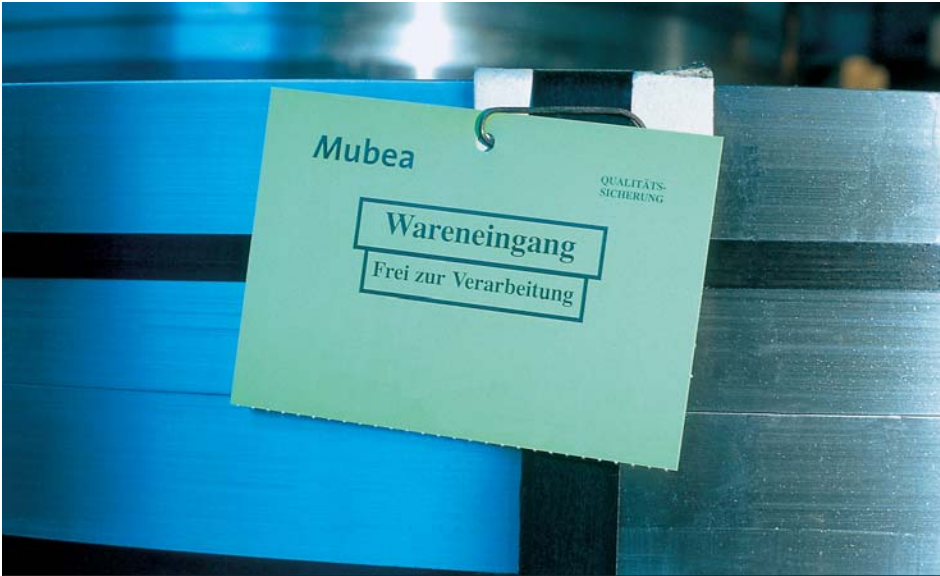

Raw material

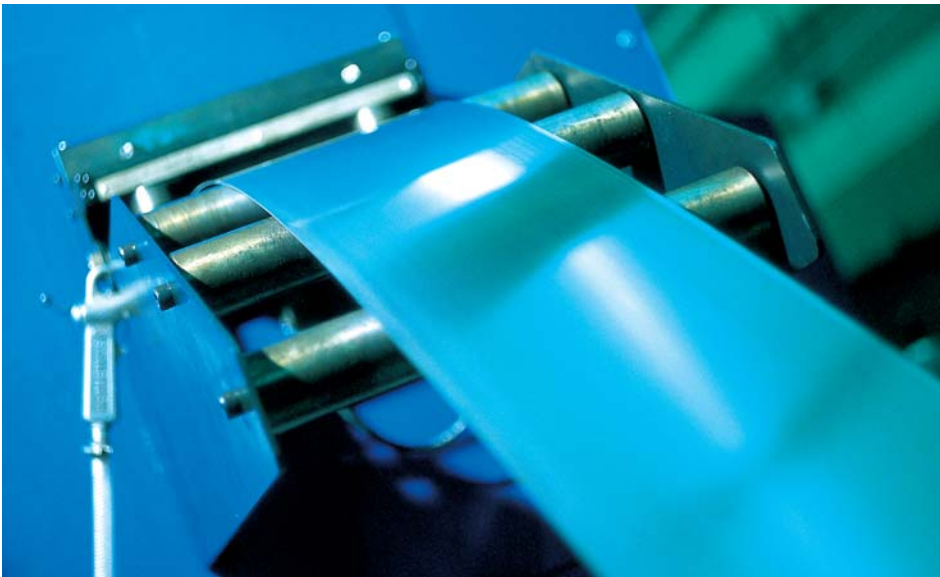

Fine blanking



Flame cutting

# Mubea Disc Springs

Deburring



Heat treating

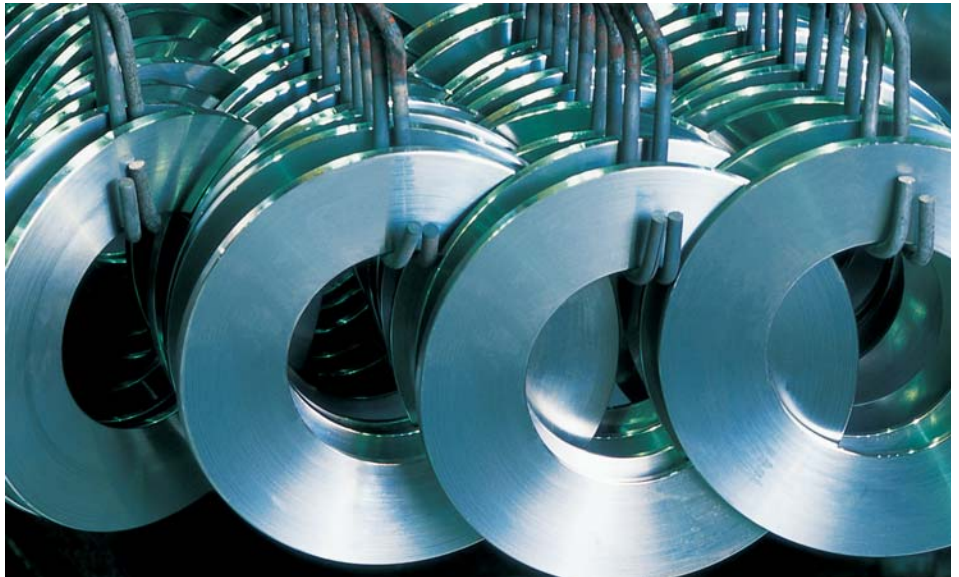

Shot peening

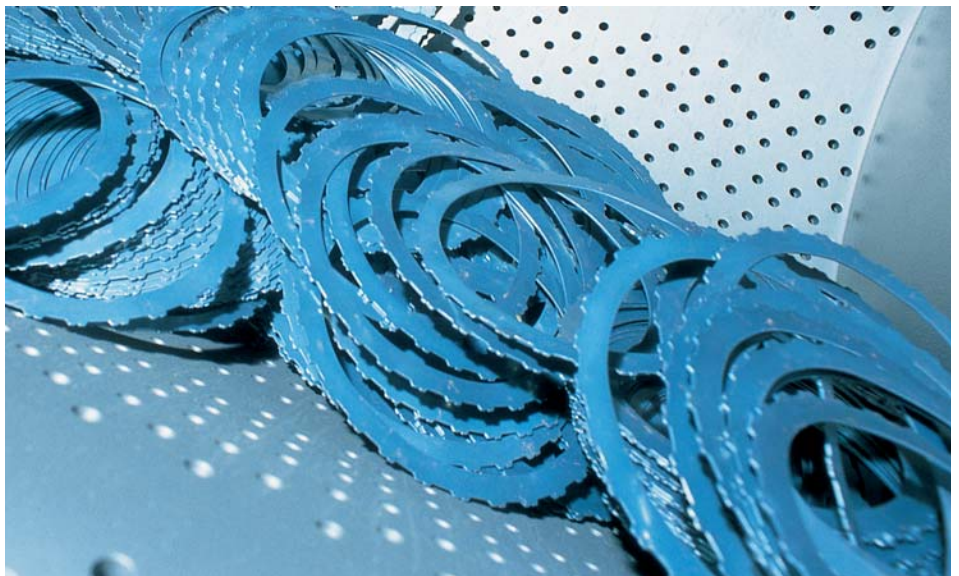





Corrosion protection



Quality assurance



Final product



# Design and Theory



- 3.1 Design**
- 3.1.1 Quick selection guide
  - | Data sheet
- 3.1.2 Mubea's Calculation Program
  
- 3.2 Disc spring theory**
- 3.2.1 Properties and construction
- 3.2.2 Classification according to DIN 2093
- 3.2.3 Evaluation of individual disc springs
  - | Disc springs without contact surfaces with force application per DIN
  - | Disc springs without contact surfaces with force application through shortened lever arms
  - | Disc springs with contact surfaces
  - | Special cases
- 3.2.4 Disc spring combinations
  - | Spring stack design
  - | Spring stack design guidelines
  - | Spring stack guides
- 3.2.5 Calculating allowable load stresses
- 3.2.6 Relaxation and creep
- 3.2.7 Friction
  - | Friction for an individual disc spring
  - | Friction in stacks of disc springs arranged in parallel
  - | Friction in stacks of disc springs in series
  
- 3.3 Symbols, signs, denominations and units**

## 3.1. Design

### 3.1.1 Quick selection guide

Disc springs can be designed to meet the specific requirements of a variety of applications. These requirements can typically be met with springs from Mubea's standard product line. Our standard product line includes disc springs designed per the requirements of DIN 2093, our own internal factory standards, as well as other special sizes. Disc springs from our standard product line are typically available from stock for immediate delivery.

Disc springs can also be designed with non-standard dimensions. Depending upon the availability of material and tooling requirements, delivery times may be longer. In such cases one should consider whether the additional cost and longer delivery is justifiable. Below is a brief guide to support quick and accurate disc spring design.

As a minimum, the following information about the application is required:

- | available mounting space
- | required spring loads
- | type of load
- | required number of load cycles
- | operating conditions (operating temperature, operating medium, corrosion protection)

Mubea's Datasheet for the Design of Disc Springs shown in Fig. 3.1 provides a good basis for summarising the requirements of a given application.

**Copy, complete and  
fax in datasheet.  
Or go directly to  
[www.mubea-discsprings.com](http://www.mubea-discsprings.com)**

For a majority of applications, the materials specified in DIN 2093 or Mubea's Factory Standard (Ck 67, 50 CrV 4) are sufficient. As a standard, Mubea's springs are phosphated and oiled. Other available surface coatings are listed in Section 5.2. Applications requiring a high level of corrosion resistance, operation at extreme temperatures, antimagnetism etc. require the use of special materials, which is explained in greater detail in Section 5.1. Please contact Mubea regarding spring designs for applications requiring special materials.

If the desired mounting space is fixed, it first needs to be determined if disc springs from our standard product line can be used. The dimensions for these disc springs can be obtained from Section 6. The tables also specify the loads for the respective spring at varying deflections. Furthermore, detailed spring characteristics can be found in the section containing graphs for springs per DIN 2093. The graphs also enable the fatigue life to be estimated. Refer to Section 6.2 for an explanation of the graphs. If a standard spring will not work for an application, disc springs can also be custom designed with the aid of the Mubea Calculation Program described in Section 3.1.2. Please contact Mubea if additional assistance is required. It is preferable that the design of disc spring stacks should be done with the Mubea Calculation Program.

**DATENBLATT ZUR AUSLEGUNG VON TELLERFEDERN** (Bitte ausfüllen bzw. Zutreffendes ankreuzen)  
**DATA SHEET FOR THE DESIGN OF DISC SPRINGS** (please fill in/check off where applicable)  
**DONNÉES TECHNIQUES** (S.v.p. remplir ou mettre une croix)

Mubea Tellerfedern und Spannelemente GmbH  
 Im Kirdorf • 57567 Daaden • Tel. +49/27 43 806 0  
**Fax +49/27 43 806 188**

- 1) **Art der Maschine bzw. Anlage:** \_\_\_\_\_  
 Kind of machine/plant:  
 Type de machine/application: \_\_\_\_\_
  
- 2) **Zweck der Federn:** \_\_\_\_\_  
 Purpose of the springs:  
 Usage des rondelles: \_\_\_\_\_
  
- 3) **Einbauraum:** Durchmesser  $D_{max} =$  \_\_\_\_\_  $D_{min} =$  \_\_\_\_\_ mm  
 Mounting space: Diameter  
 Dimensions: Diamètre  
 Länge/length/longueur  $L_{max} =$  \_\_\_\_\_  $L_{min} =$  \_\_\_\_\_ mm
  
- 4) **Schichtungsart/Method of stacking/Mode d'empilage:** \_\_\_\_\_
  
- 5) **Kräfte und Federwege/Forces and deflections/Forces et courses:**  
 $L_1 =$  \_\_\_\_\_ mm  $s_1 =$  \_\_\_\_\_ mm  $F_1 =$  \_\_\_\_\_ N Tol: + \_\_\_\_\_ % Tol: - \_\_\_\_\_ %  
 $L_2 =$  \_\_\_\_\_ mm  $s_2 =$  \_\_\_\_\_ mm  $F_2 =$  \_\_\_\_\_ N Tol: + \_\_\_\_\_ % Tol: - \_\_\_\_\_ %  
 $L_3 =$  \_\_\_\_\_ mm  $s_3 =$  \_\_\_\_\_ mm  $F_3 =$  \_\_\_\_\_ N Tol: + \_\_\_\_\_ % Tol: - \_\_\_\_\_ %
  
- 6) **Art der Belastung/Type of load/Mode de fonctionnement:**  
 statisch/static/statique  dynamisch/dynamic/dynamique
  
- 7) **Belastungsverlauf/Application of load/Allure de courbes:**  
 stoßartig/shock/amortissement  sinusförmig/sinusoidal/sinusoïdale
  
- 8) **Erwünschte Lebensdauer:** \_\_\_\_\_  
 Requested fatigue life:  
 Durée de vie souhaitée: \_\_\_\_\_
  
- 9) **Betriebstemperatur (an der Feder):** \_\_\_\_\_  
 Working temperature (at spring):  
 Température de fonctionnement (au ressort): \_\_\_\_\_
  
- 10) **Führung:**  innen  außen  
 Guide method: inside outside  
 Guide: intérieur extérieur
  
- 11) **Lage der Feder bzw. Säule:**  vertikal  horizontal  
 Location of spring/stack: horizontal vertical  
 Position de la rondelle ressort/d'empilage: horizontal vertical
  
- 12) **Ist ein besonderer Korrosionsschutz erforderlich?** \_\_\_\_\_  
 Is a special protection against corrosion required?  
 A-t-on besoin d'une protection particulière contre la corrosion?
  
- 13) **Angreifendes Medium/Aggressive medium/A quoi est dû la corrosion:** \_\_\_\_\_
  
- 14) **Bemerkungen/Remarks/Remarques:** \_\_\_\_\_

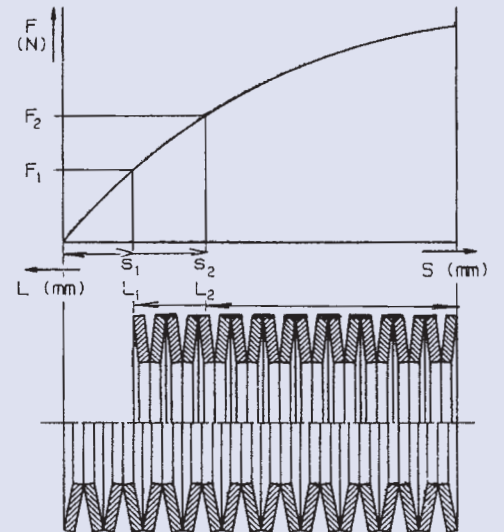

Sachbearbeiter/Responsible/Responsable Produit: \_\_\_\_\_

Telefon/Phone/Téléphone: \_\_\_\_\_ Telefax/Fax/Téléfax: \_\_\_\_\_

Datum/Date/Date: \_\_\_\_\_ Unterschrift/Signature/Signature: \_\_\_\_\_

### 3.1.2 Mubea's Calculation Program

Detailed design calculations can be made with the aid of the **Calculation Program for the Design of Disc Springs** available from Mubea. This program aids in the optimum selection of either individual springs or combinations of stacked springs based upon available mounting space and fatigue life requirements. This program can also evaluate springs made from a variety of materials.

The Calculation Program can be obtained from the enclosed CD or downloaded from the internet at [www.mubea-discsprings.com](http://www.mubea-discsprings.com). Operation instructions for the program are provided on the CD and Mubea's website. The program can estimate fatigue life for:

- | spring stacks containing up to 60 individual disc springs stacked in series
- | spring stacks consisting of up to 15 spring packs containing 2 springs stacked in parallel
- | for springs less than 16mm thick
- | for springs stressed within allowable limits.

Applications with requirements outside of those listed above should be discussed with Mubea.

## 3.2 Disc spring theory

Disc springs are shallow conical rings that are subjected to axial loads (*Fig. 3.2*). Normally the ring thickness is constant and the applied load is evenly distributed over the upper inside and lower outside edges. Disc springs are generally manufactured from spring steel and can be subjected to static loads, rarely alternating loads, and dynamic loads. Disc springs can meet the most stringent fatigue life and set loss requirements.

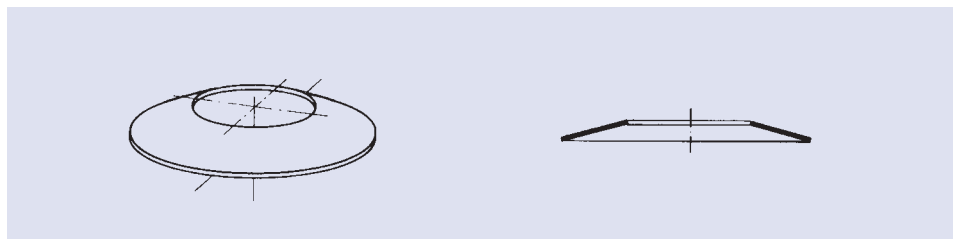

Fig. 3.2: Single disc spring

Disc springs are distinguished from other spring types by the following characteristics:

- | high load capacity with a small spring deflection
- | high space utilisation when compared with other types of springs
- | high fatigue life and low set loss/creep when properly sized
- | different combinations of springs can be designed to achieve the desired load characteristics
- | a variety of special materials and surface coatings can be used
- | cost-effective, as a result of standardised sizes.

### 3.2.1 Properties and construction

The characteristic load curve is a representation of the force-deflection behaviour of the spring. Depending upon the dimensional ratios, the characteristic load curve of a disc spring is more or less digressive up to the flat position (*Fig. 3.3*). In special cases, disc springs can be designed so that deflection beyond the flat position is possible. Typically, disc springs are



used as modular components. A group of individual disc springs stacked facing the same way is called a parallel spring stack. A group of individual disc springs or parallel spring stacks that are stacked facing alternate ways is called a series spring stack (Fig. 3.4/3.5). In a parallel spring stack, the deflection of the stack is equal to that of the individual spring. The load at a given deflection is proportional to the number of individual springs in the stack. In a series spring stack, the deflection of the stack is the sum of the deflections of the individual springs. The load of the stack is equal to the load on the individual spring. When calculating the spring deflection and load capacity of a stack composed of individual springs or spring packs these facts must be taken into consideration (Fig. 3.6).

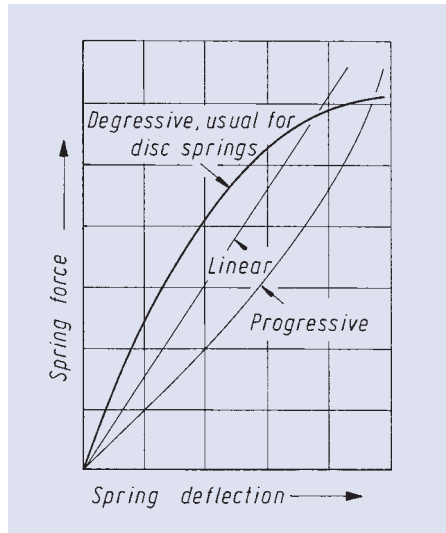

Fig. 3.3: Typical characteristic curves

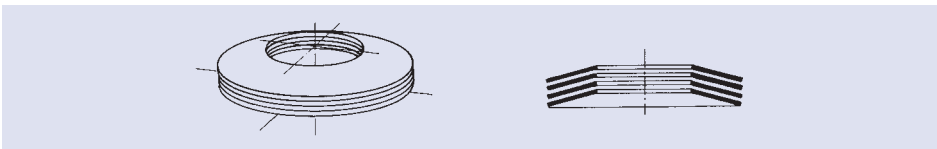

Fig. 3.4: Stack consisting of four individual springs arranged in parallel

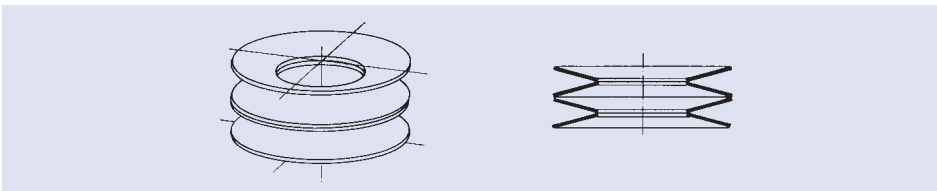

Fig. 3.5: Stack consisting of four individual springs arranged in series

It is possible to generate progressive characteristic curves by combining parallel spring stacks containing different numbers of disc springs or single disc springs of varying thickness to form a stack. In these cases the packs or single discs with the lower load capacity do not contribute to the deflection of the stack after reaching the flat position or their upper stroke limits, with the result that the total spring rate of the stack rises (Fig. 3.7).

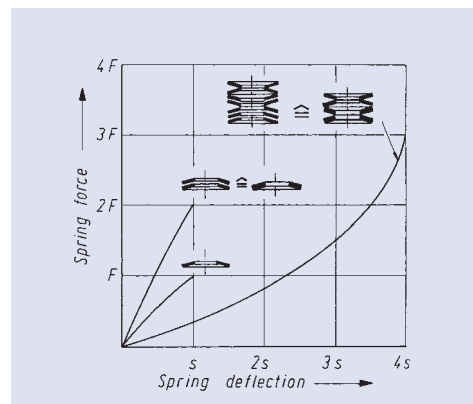
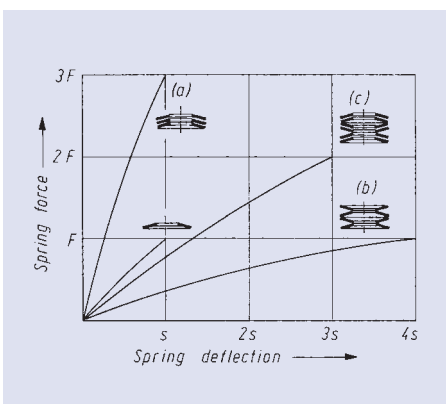

Fig. 3.6, left: Various combinations of disc springs: a) stack of 3 individual disc springs in parallel: force multiplied by 3 b) stack of 4 individual disc springs in series: deflection multiplied by 4 c) series stack consisting of 3 parallel stacks, each parallel stack contains 2 individual disc springs: deflection multiplied by 3, force multiplied by 2

Fig. 3.7, right: Combination of disc springs designed to yield a progressive characteristic load curve

### 3.2.2 Classification according to DIN 2093

Disc spring design, sizing, and manufacture have been standardised according to DIN 2092 (Disc springs, Calculation) and DIN 2093 (Disc springs, Calculation, Dimensions, Quality requirements). Disc springs in accordance with DIN 2093 are classified into 3 groups:

- | Group 1: Disc thickness,  $t$ , less than 1.25 mm
- | Group 2: Disc thickness,  $t$ , from 1.25 mm to 6 mm
- | Group 3: Disc thickness,  $t$ , over 6 mm up to 14 mm

Group 1 and 2 springs are manufactured without contact surfaces (Fig. 3.8), Group 3 springs are manufactured with contact surfaces (Fig. 3.9).

Fig. 3.8, left:  
Group 1 and 2 springs  
without contact surfaces

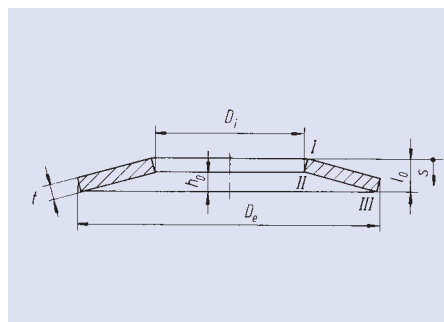
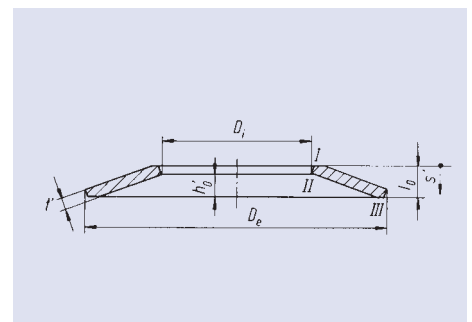

Fig. 3.9, right:  
Group 3 springs  
with contact surfaces



The requirements of springs manufactured to DIN 2093 are summarised in the table below (Table 3.1).

Group	Production Method	Surface Finish**)	
		Upper and lower surfaces $\mu\text{m}$	Inner and outer edges $\mu\text{m}$
1	stamped, cold-formed, edges rounded	$R_a < 3,2$	$R_a < 12,5$
2 <sup>1)</sup>	stamped, cold-formed, $D_e$ and $D_i$ turned, edges rounded	$R_a < 6,3$	$R_a < 6,3$
	fine-blanked, cold-formed, edges rounded	$R_a < 6,3$	$R_a < 3,2$
3	cold- or hot-formed, turned on all sides, edges rounded	$R_a < 12,5$	$R_a < 12,5$

<sup>1)</sup> Unless otherwise specified, the manufacturing process is left to the discretion of the manufacturer (see Section 5 in DIN 2093).

\*\*<sup>2)</sup> The specified values do not apply to shot-peened disc springs.

Table 3.1  
Production method and  
permissible surface finish

Other production methods, such as laser-beam cutting or water-jet cutting etc. may be used for the production of special disc springs. In addition to disc springs with a rectangular cross-section and rounded edges, there are the following types:

- | disc springs with a trapezoidal cross-section and
- | disc springs with slots

Slotted disc springs are used extensively in couplings and transmissions while those with a trapezoidal cross section are not typically used. These types of springs are not covered in this catalog. However, Mubea can assist in the selection of slotted springs.

### 3.2.3 Evaluation of individual disc springs

Although more accurate analytical equations exist for the evaluation of disc spring behaviour, the simplified equations of DIN 2092 are sufficiently accurate. The equations in DIN 2092 are essentially derived from calculations developed by ALMEN and LÁSZLÓ.

According to these equations, the deformation behaviour of the disc spring is treated as a one-dimensional inversion of a circular ring of rectangular cross-section about a center of inversion  $S$ . The resulting inverted stress condition is overlaid by a bending stress condition caused by the change in the cone angle resulting from the deflection. The cross-section of the disc spring remains rectangular, so that force is always applied at the edges I and III.

The behaviour of the material is regarded as linear-elastic without limit. Residual stresses are not taken into account. The calculated stresses are nominal stresses. Mubea has computer-aided calculation programs available for the design of disc springs (see Section 3.1).

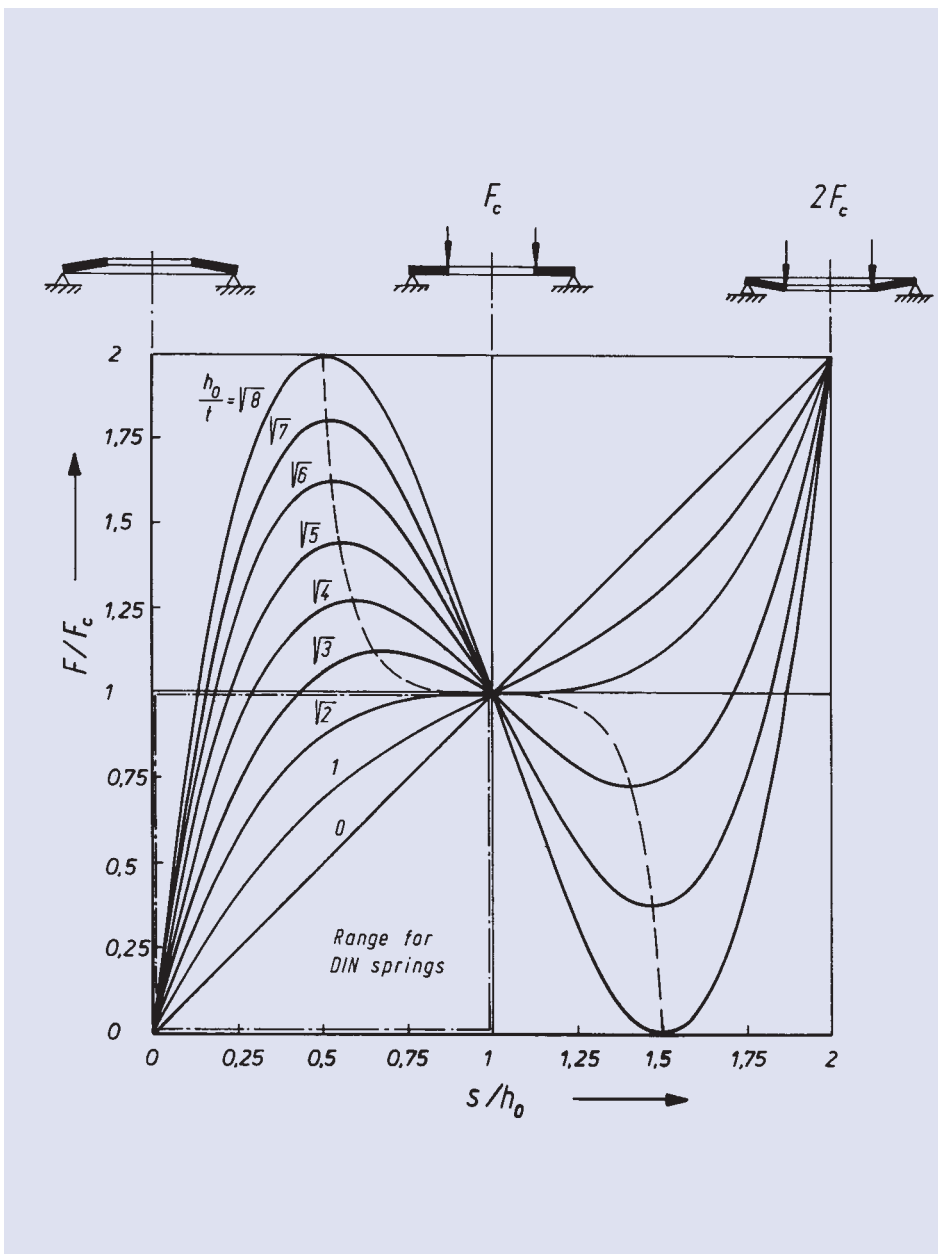

Fig. 3.10: Relative calculated characteristic load curves. Deflection: refers to the spring deflection up to flat position  $s = s_c = h_0$ . Spring force: refers to the spring force in the flat position  $F_c = F(h_0)$

### Disc springs without contact surfaces with force application per DIN

#### Specifications

The characteristic load curve for a disc spring is defined by the  $h_0/t$  ratio. Assuming unrestricted spring deformation and adherence to permissible load limits, the characteristic load curves shown in Fig. 3.10 are obtained. The characteristic curves shown in Fig. 3.11 are specifically for Series A, B and C springs standardised according to DIN 2093.

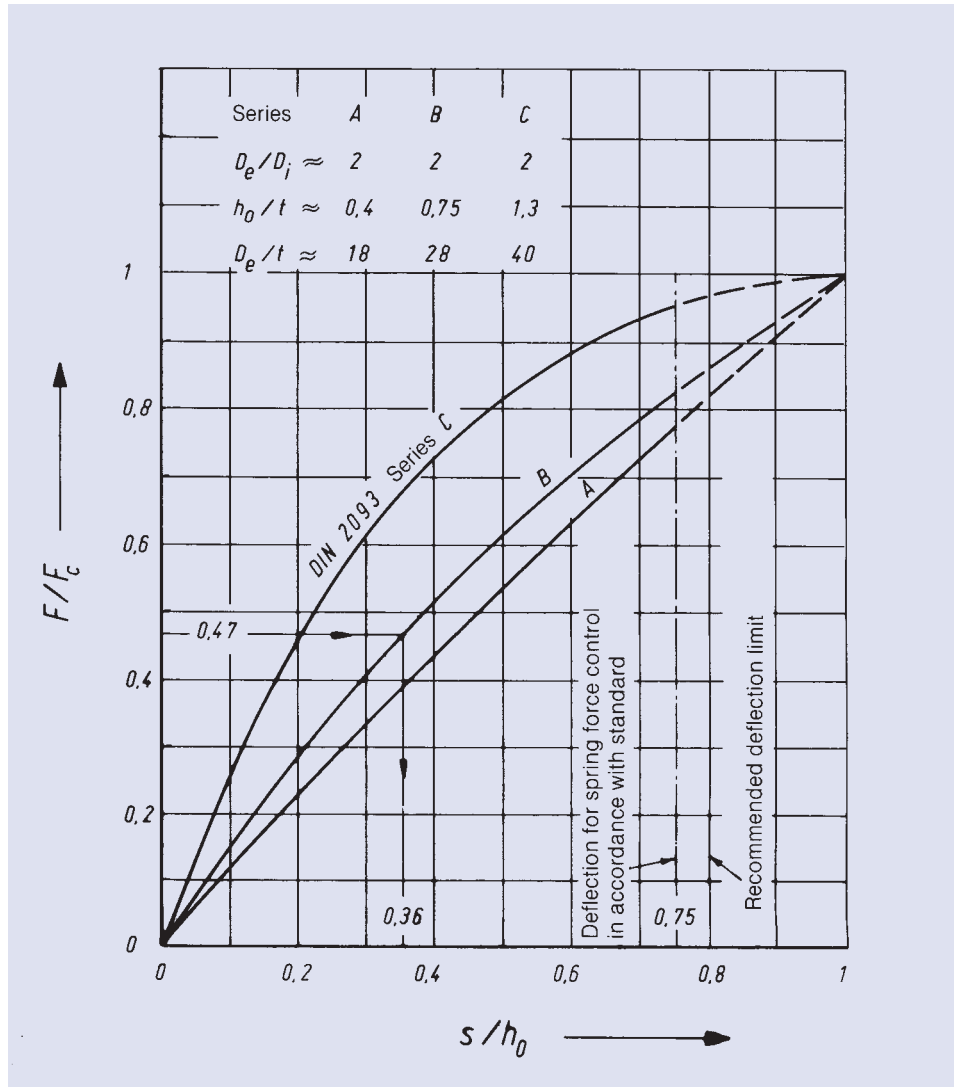

Fig. 3.11: Calculated characteristic load curves for disc springs to DIN 2093, Series A, B and C, as well as the recommended deflection limit. The upper section of the graph shows the average spring parameters for the standard spring series

#### Load stresses

The fatigue life of the disc spring is dependant upon the stresses that run tangentially, while the stresses running radially are negligibly small. Typically, compressive stresses act on the upper side of the disc and tensile stresses on the lower side.

The calculated stresses do not correspond to the actual stresses in the spring. This is due to residual stresses caused by shot-peening and presetting. The actual stresses are a combination of the residual stresses and the load stresses (Fig. 3.12). The dynamic strength of the spring is dependant upon the tensile stresses on the underside of the disc. Due to the residual stresses introduced in our production process, the calculated stress levels are higher than the actual stress levels.

Depending on the  $h_0/t$  ratio, the maximum tensile stress will occur at cross-section point II (inner diameter bottom) or III (outer diameter bottom).

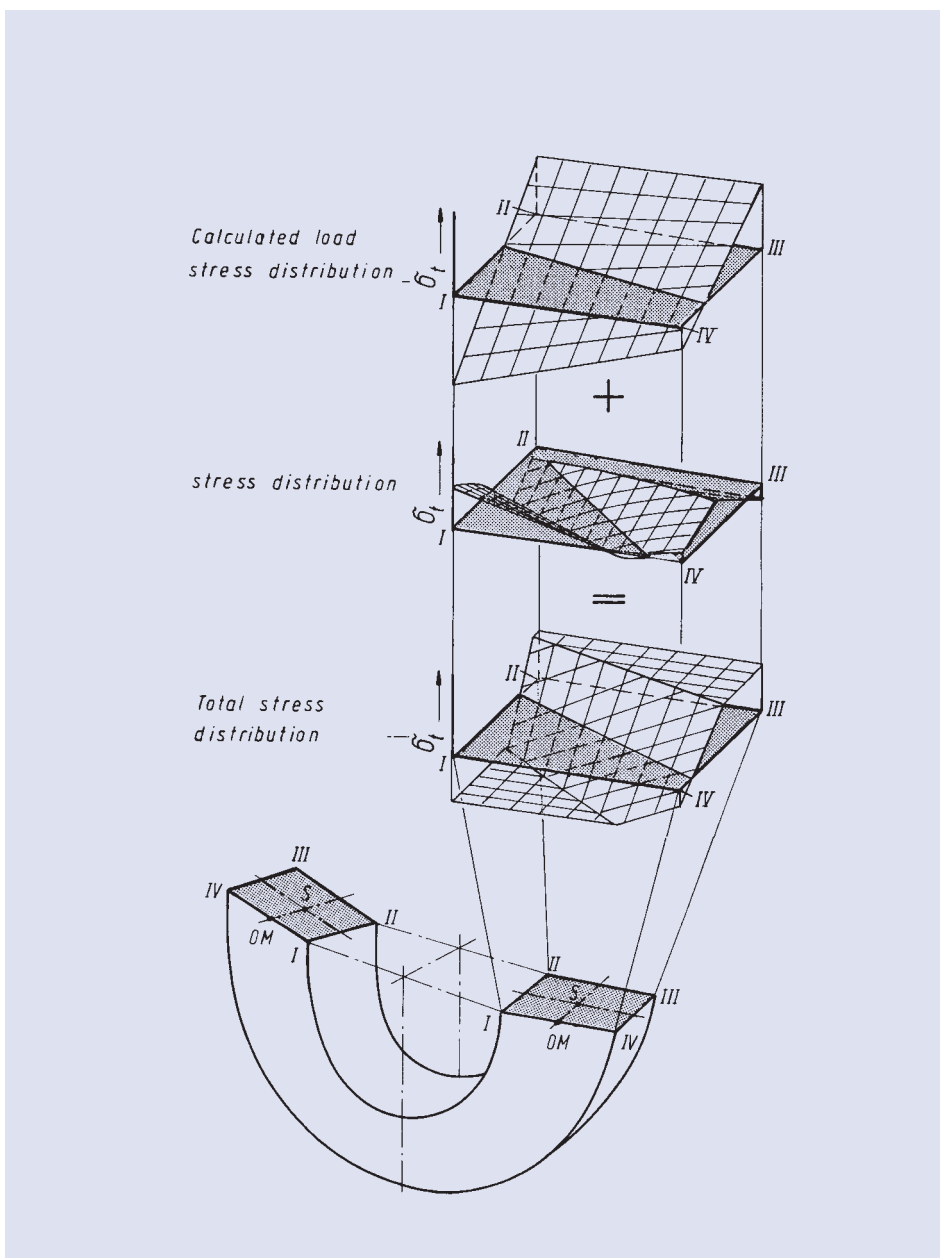

Fig. 3.12: Overlay of load stresses and residual stresses to give total stresses

On the upper side of the spring, the maximum compressive stress occurs on the inside edge of the spring at cross-section point I. This stress determines the set loss of the spring. Setting is caused by plastic deformation of the disc spring due to high deflections that exceed the elastic limit of the material. This results in a reduction in the free height of the spring.

### Disc springs without contact surfaces with force application through shortened lever arms

For the deformation model typically used, the moment required to achieve a given deflection when force is applied through shortened lever arms, is of exactly the same magnitude as the moment required when the load is applied at points I and III of the spring cross section.

Because of the shortened lever arm a greater load  $F' > F$  is required to achieve the same spring deflection. The result is a steeper characteristic load curve when compared with a spring subjected to normal loading. The calculated load stress is not influenced by the location of load application. It depends only on the variation of the cone angle (Fig. 3.13).

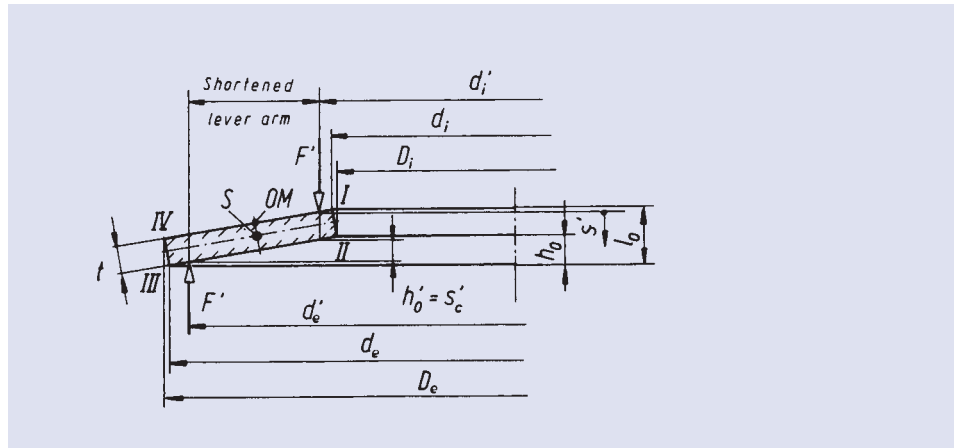

Fig. 3.13: Dimensional relationships when load is applied via a shortened lever arm

### Disc springs with contact surfaces

Contact surfaces are used for disc springs with a thickness greater than 6 mm (Group 3 of DIN 2093). This provides a larger area for load application thereby reducing the friction on the guide elements. The location of the applied force is shifted from  $d_e$  to  $d_e'$  on the outside and from  $d_i$  to  $d_i'$  on the inside. This results in a shortening of the lever arm and an increase in the characteristic load curve (Fig. 3.14).

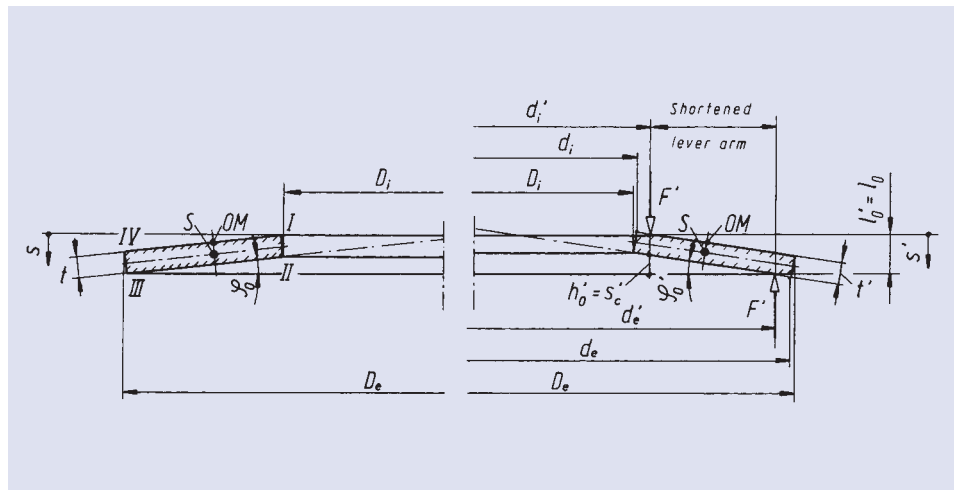

Fig. 3.14: Comparison of a disc spring without contact surfaces (left) and a disc spring with contact surfaces (right)

Disc springs with contact surfaces have the same design force  $F$  (at a deflection  $s = 0.75 \cdot h_0$ ) as disc springs without contact surfaces with the same dimensions  $D_e$ ,  $D_i$  and  $l_0$ .

The resulting increase in force is counteracted by a reduction in the disc thickness. Due to the requirement for identical overall height  $l_0$ , the disc spring with contact surfaces will have a greater cone angle  $\varphi_0' > \varphi_0$ . This results in a characteristic curve which, with the exception of the common design point  $F' (s=0,75 h_0) = F (s=0,75 h_0)$ , deviates slightly from that for the standard disc spring (Fig. 3.15).

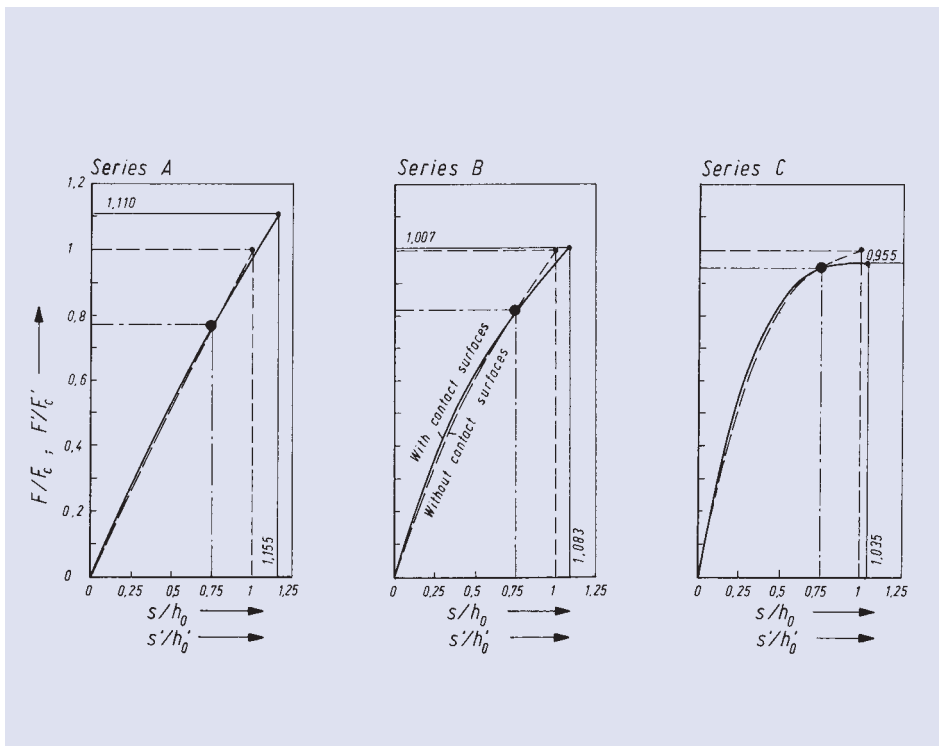

Fig. 3.15: Comparison of the calculated characteristic curves of disc springs with and without contact surfaces

The reduction of the disc thickness from  $t$  to  $t'$  is specified in DIN 2093. The average ratio of disc thickness between  $t'$  and  $t$  is .938 for Series A and B springs, and .995 for Series C springs. The load stresses are calculated for the corner points I ... IV of the cross section, which no longer exist because of the contact surfaces. Therefore the calculated stresses are somewhat higher than the values that would be obtained for the actual corner areas with a more precise calculation. Since these are only nominal values, the error is insignificant.

### Special cases

#### Conversions when using special materials

The characteristic equations applicable to a sharp-edged rectangular cross section yield forces which are 8 % to 9 % too high for spring steel where  $E = 206000 \text{ N/mm}^2$  and  $\mu = 0.3$ . This is compensated for by the shortening of the lever arm due to the radii at points I and III. Therefore the calculated and measured loads for steel springs correlate closely. This is no longer true if special materials, especially ones with higher POISSON ratio  $\mu$ , are used.

#### Extremely thin disc springs

In the case of disc springs where  $D_e/t \gg 40$  the characteristic equation yields a force which is too high. In this case, the cross section of the spring is no longer rectangular and deflection over the spring cross section must be taken into consideration (especially if a finite element analysis is made).

#### Extremely small diameter ratio

In the case of disc springs with  $D_e/D_i < 1.8$ , the shortening of the lever arm due to the corner radii must be taken into consideration when calculating the characteristic load curve. Otherwise the calculated load will be too low.

### 3.2.4 Disc spring combinations

As already mentioned at the beginning of this section, disc springs can be combined in many different ways to form parallel or series stacks or a combination thereof. The following information is only for disc springs without contact surfaces. It can also be applied to disc springs with contact surfaces. However it must be noted that the reduction of the disc thickness from  $t$  to  $t'$  results in a shortening of the parallel spring stack or series spring stack containing groups of parallel spring packs.

#### Spring stack design

##### Stack of the disc springs in parallel

For spring stacks consisting of  $n$  identical disc springs arranged in parallel, the force calculated for a single spring is multiplied by a factor  $n$  for a constant spring deflection (Fig. 3.16).

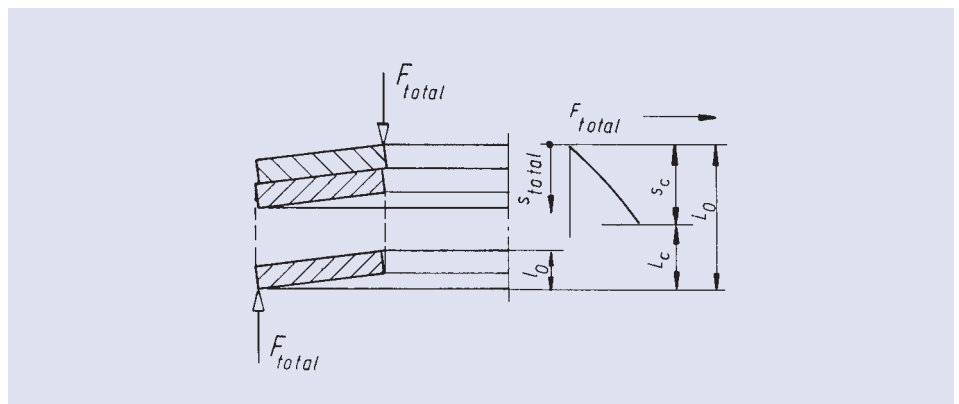

Fig. 3.16: Parallel spring stack consisting of  $n$  individual disc springs (the deflection is enlarged for clarity)

The length  $L_0$  of the unloaded spring pack is calculated as  $L_0 = l_0 + (n-1) t$ .

If friction is disregarded, the following equations are obtained:

| deflection:  $s_{tot} = s$

| spring force:  $F_{tot} = n \cdot F$

##### Stack of disc springs in series

For spring stacks consisting of  $i$  individual disc springs arranged in series, the deflection is multiplied by a factor of  $i$  for a constant load (Fig. 3.17).

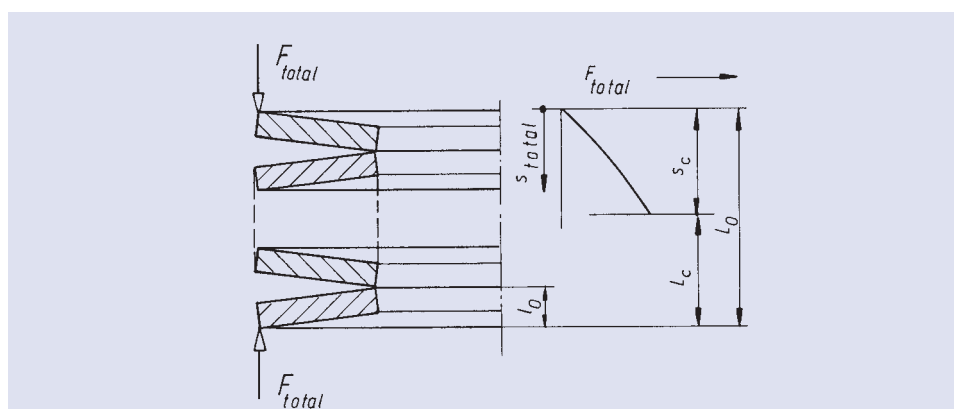

Fig. 3.17: Series spring stack consisting of  $i$  individual disc springs



The length of the unloaded series spring stack of single springs is calculated as  $L_0 = i \cdot l_0$ . If friction is disregarded, the following equations are obtained:

| deflection:  $s_{\text{total}} = i \cdot s$

| spring force:  $F_{\text{total}} = F$

### Progressive characteristic load curves

Progressive characteristic load curves can be obtained with the use of parallel stacks with different numbers of disc springs combined to yield compound series stacks (high friction) or series stacks comprised of individual disc springs of varying thickness and overall height (low friction) as shown in Fig. 3.7. The progression is achieved because the weaker stack – or weaker spring – is cancelled out and thus no longer contributes to the compression of the stack after reaching either the flat position or the deflection limiter (Fig. 3.18).

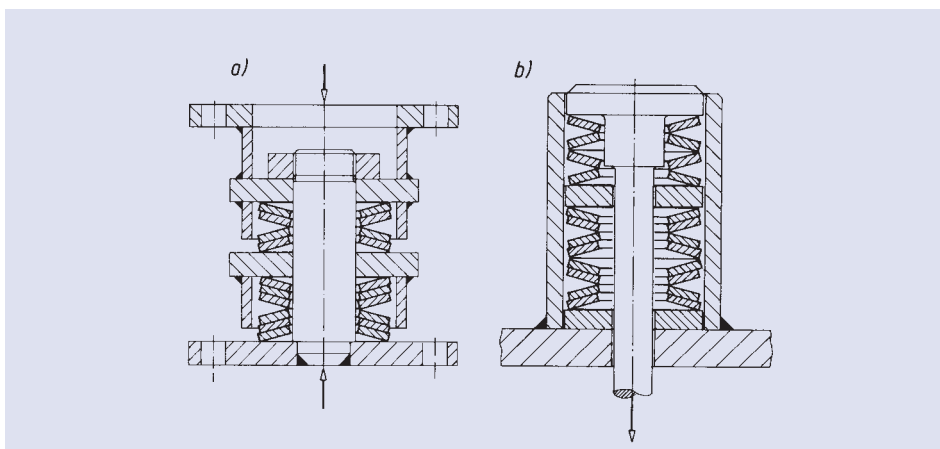

Fig. 3.18: Spring stacks with progressive characteristic load curves and stroke limiters to avoid overload  
a) Bell b) Stop

### Spring stack design guidelines

The following guidelines should be considered in the design of disc spring stacks:

- | Individual springs stacked in series are used if the deflection of the individual spring is not sufficient.
- | Single springs stacked in parallel are used if high loads have to be obtained in a limited mounting space.
- | A large spring diameter enables a low overall height to be achieved.
- | Normally no more than 2 ... 4 springs should be stacked in parallel since the discrepancies between the calculated and measured characteristic load curves increase with an increasing number of discs due to friction (the influence of friction is not taken into consideration in the calculation program).

### Spring stack guides

Both series and parallel spring stacks should be guided. This is done with a guide element such as

- | a guide rod (*internal guidance, Fig. 3.19 a*)
- | a guide sleeve (*external guidance, Fig. 3.19 b*) or by
- | self-centering devices (*balls, Fig. 3.19 c*)
- or by hardened wire segments.

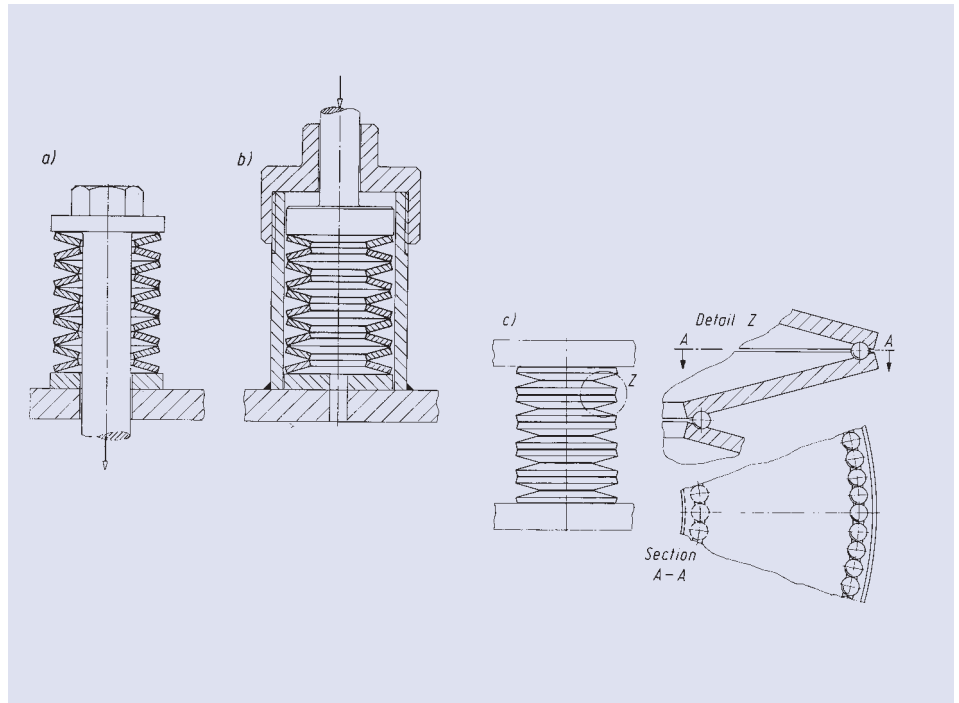
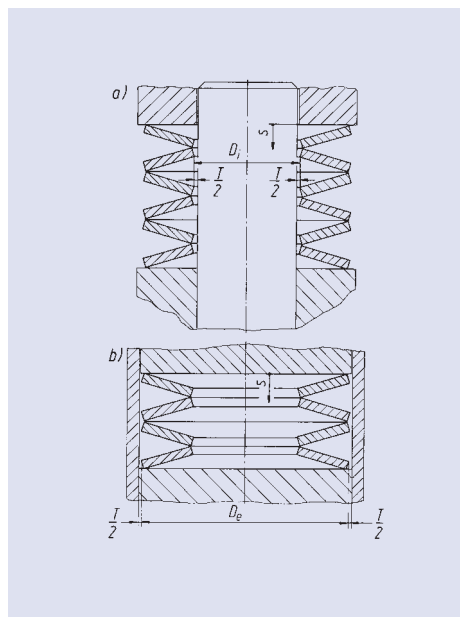

**Fig. 3.19:**  
Different types of  
spring stack guides

Both internal and external guides should be polished over their entire length and hardened to at least 55 HRC.

In the case of purely static or rarely alternating loads, an un-hardened guide element can be used. In spring stacks, the load can be applied via either the inner or the outer diameter. If the load is applied via the inner diameter the contact pressures will be higher.

Both internal and external guides require some clearance,  $T$ , between the spring stack and guide element (Fig. 3.20). This allows adequate room for the displacement of the lubricant while ensuring proper guidance. Table 3.2 shows the total clearance,  $T$ , for both types of guides, depending on the disc inner diameter  $D_i$  (in the case of internal guides) or the disc spring outer diameter  $D_e$  (in the case of external guides).



**Fig. 3.20:**  
Spring stack guides  
(a) internal (b) external,  
clearance,  $T$ , between  
springs and guide  
element

**Table 3.2:** Total clearance  
between the disc spring  
and guide element

$D_i$ or $D_e$ (mm)	Total clearance $T$ (mm)
– up to 16,0	0,2
over 16 up to 20,0	0,3
over 20 up to 26,0	0,4
over 26 up to 31,5	0,5
over 31,5 up to 50,0	0,6
over 50 up to 80,0	0,8
over 80 up to 140,0	1,0
over 140 up to 250,0	1,6
over 250 –	2,0

### Self-centering disc spring stacks

A guide element is not required for self-centering spring stacks. In practice, 3 types of self-centering disc spring stacks are currently used.

#### a) Ball-centered disc spring stacks

The disc springs have flat annular grooves on the inner and outer diameter, into which hardened steel balls are inserted. This type of guidance is virtually friction-free. Ball-centering is primarily used on stacks of large disc springs.



Fig. 3.21:  
Ball-centered stack

#### b) Wire-centered disc spring stacks

A wire-centered disc spring stack is a more cost-effective alternative to the ball-centered stack. In this arrangement, wire segments are substituted for the steel balls. However, the friction is slightly higher than with ball centering.



Fig. 3.22:  
Wire-centered stack

#### c) Alternative stack guide

A retaining ring or T-ring may also be used for centring disc spring stacks.



Fig. 3.23: Retaining  
ring centered stack

### 3.2.5 Calculating allowable load stresses

The allowable stresses depend upon the type of loading that the spring is subjected to (Fig. 3.24).

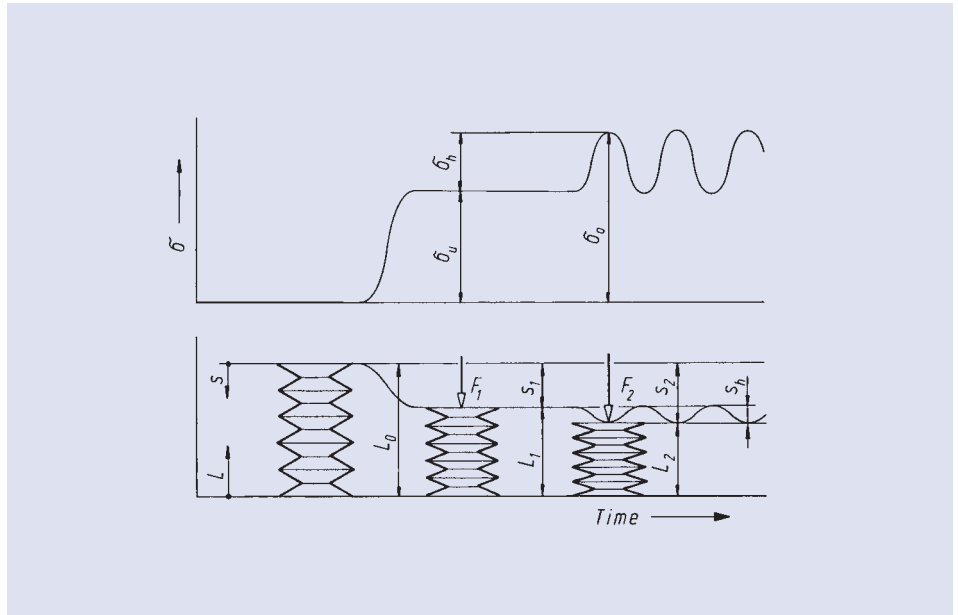

Fig. 3.24: Representation of motion as a function of time during dynamic loading  
 Top: stress - versus - time function  
 Bottom: deflection - versus - time function

3 types of loading are considered:

- a) Static or rarely alternating loads with fewer than  $10^4$  load cycles over the required life of the spring
- b) Alternating loads with  $10^4 < N < 2 \cdot 10^6$  load cycles over the required life of the spring
- c) Alternating loads with  $N > 2 \cdot 10^6$  load cycles over the required life of the spring

a) For applications with a static or rarely alternating load, the highest calculated stress at the upper inner edge of the single spring (cross-sectional point I) is the most critical. The stress at cross-sectional point I has the highest magnitude and thus determines the set loss of the spring. For springs made of high grade steel as specified by DIN 17221 and DIN 17222, the compressive stress calculated for point I should not exceed the values specified in Table 3.3 in the flat position  $s_c = h_0$ .

In the case of higher compressive stresses the spring may undergo a high degree of setting. If the maximum permissible calculated compressive stresses are exceeded in the case of special sizes, such springs can also undergo a high degree of setting.

$D_e/D_i$	$\sigma_{lc}$ ( $N/mm^2$ )
1,5	-2600
2,0	-3400
2,5	-3600

Tabelle 3.3: Maximum permissible stresses in the flat condition

b) and c): For applications with dynamic loading, the maximum tensile stresses on the lower side of the disc spring are critical. Fatigue fracture always begins on the lower side of the spring. Fracture will begin at cross-section II or III depending upon which position has the higher cyclical stress level.

### Minimum preload

For springs subjected to dynamic loading, the disc spring must be installed with sufficient preload to prevent fracture at the upper inside edge (cross-sectional point I). Radial surface cracks may occur at the upper inside edge due to residual tensile stresses caused by the pre-setting process.

Experience shows that the minimum compressive stress  $\sigma_I$  should be about  $-600 \text{ N/mm}^2$  for DIN springs. This corresponds to a preload deflection of  $s_u \approx 0,15 \cdot h_0 \dots 0,20 \cdot h_0$ .

While springs with lower stresses in the flat condition can have a lower preload deflection, a larger preload deflection is needed for springs with very high stresses in the flat condition.

### Fatigue strength values

The fatigue strength graphs provided here are based upon many years of testing (Fig. 3.25, 3.26, 3.27). They show the permissible calculated stress on the underside of the disc spring that is decisive for fatigue failure. The fatigue strength graphs have been calculated for disc springs of varying size and thickness and with varying numbers of load cycles.

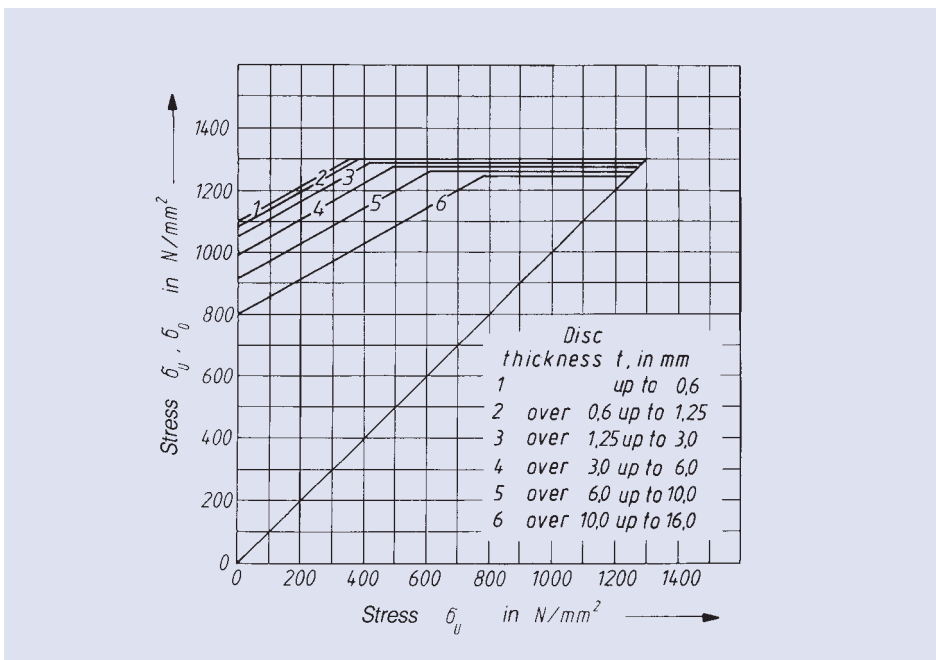

Fig. 3.25: Fatigue strength diagram for  $N = 10^5$  load cycles

The graphs apply to Group 2 and 3 disc springs made of 50 Cr V 4 and Group 1 disc springs made of Ck 67. The maximum fatigue life can be achieved with a statistical probability of 99 % under the following conditions:

- Spring stacks must be limited to a maximum of 10 individual disc springs arranged in series
- The spring or spring stack must be subjected to a sinusoidal deflection-versus-time function with a constant deflection at a constant frequency below the permissible thermal limit (see Fig. 3.24)
- Spring stacks must be assembled on guide elements (rod or sleeve) per the requirements noted in section 3.2.4. The load must be applied via hardened and polished plates at the stack ends.

- d) proper lubrication
- e) operation at room temperature and normal atmosphere  
(i.e. no excessive humidity, no corrosive chemicals, etc.)

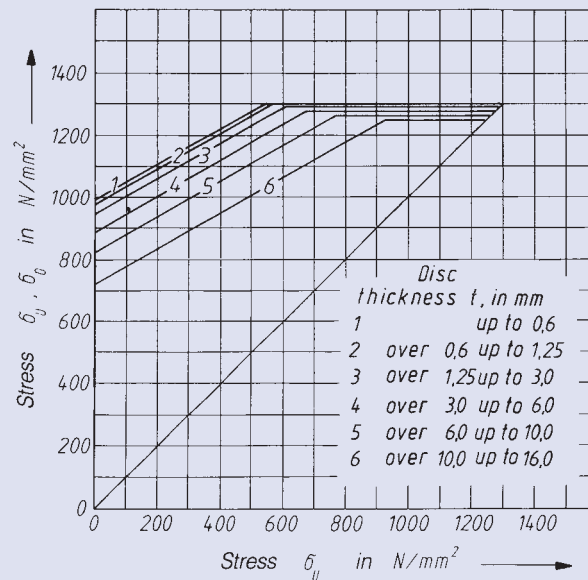

Fig. 3.26: Fatigue strength diagram for  $N = 5 \cdot 10^5$  load cycles

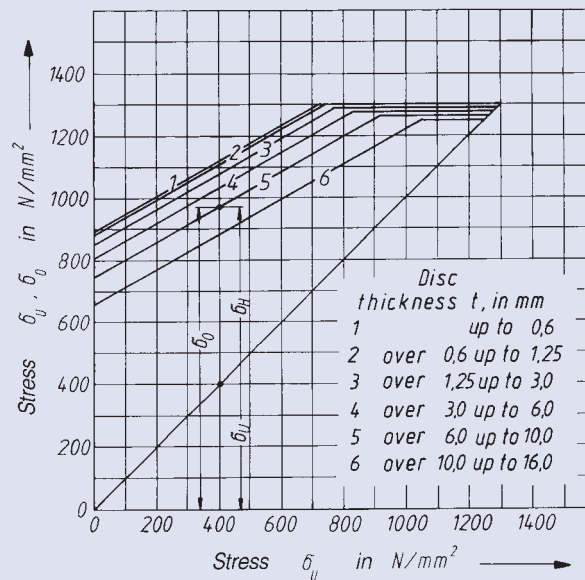

Fig. 3.27: Fatigue strength diagram for  $N = 2 \cdot 10^6$  load cycles

Deviations from these test conditions may reduce the number of load cycles that can be achieved. This applies especially to sudden loads that can occur during operation in the case of faulty lubrication, or when corrosion and surface imperfections are present.

As the number of disc springs in a stack increases, the number of load cycles that can be achieved are reduced in comparison to a single disc spring. One reason is the varying deflection of the individual springs within the stack.

This is influenced by:

- | friction between the springs and guide rod
- | friction between the springs in parallel stacks

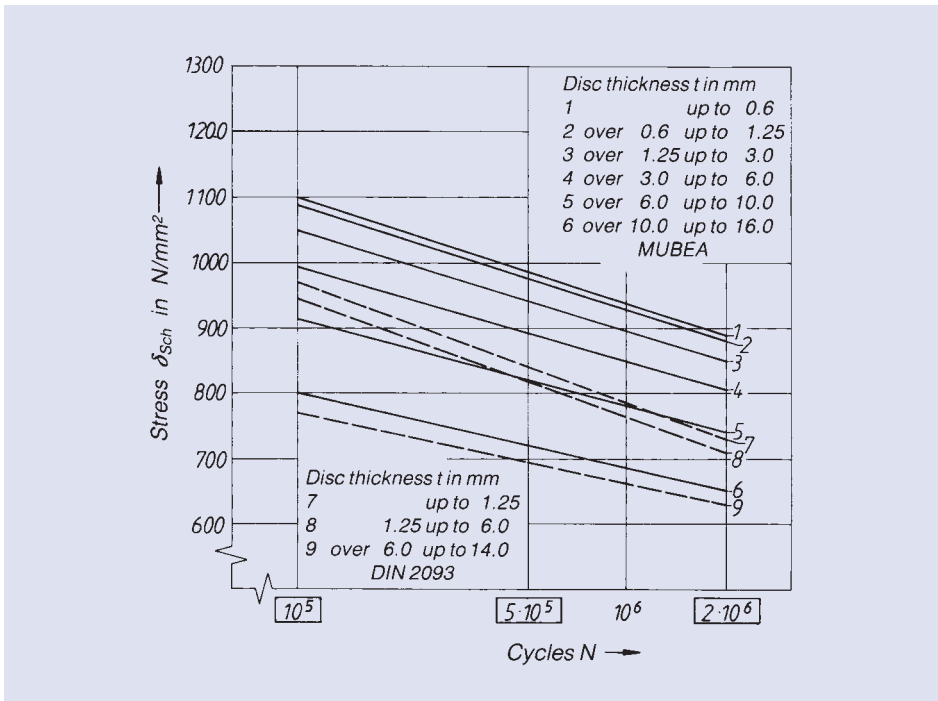

Fig. 3.28: Wöhler diagrams showing comparison between Mubea and DIN 2093

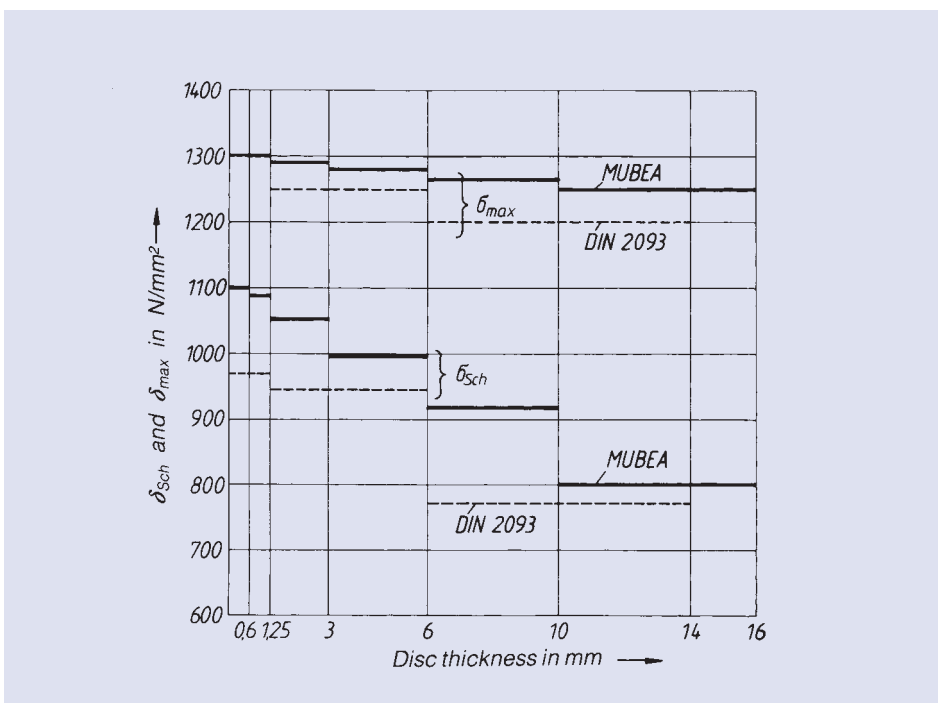

Fig. 3.29: Comparison of dynamic stresses  $\sigma_{Sch}$  and maximum allowable stresses  $\sigma_{max}$  between Mubea and DIN 2093 for  $N = 10^5$

Mubea disc springs can accept higher dynamic stress levels, or operating cycles, compared to the requirements of the DIN 2093 standard. This is shown in the fatigue strength diagrams where the dynamic stresses and the allowable stresses are compared to the corresponding values in DIN 2093 (fig. 3.28 / 3.29).

### 3.2.6 Relaxation and creep

Over time, all springs undergo a loss of elasticity. Depending on the type of load imposed on the spring, this loss of elasticity results in either relaxation or creep.

Relaxation is the decrease of force,  $\Delta F$ , seen over time if a spring is compressed to a constant length.

Creep is the decrease in spring height,  $\Delta l$ , seen over time if the spring is subjected to a constant load.

The amount of relaxation or creep is effected by the following factors:

- 1) The load stresses, especially  $\sigma_1$
- 2) The residual stresses resulting from the presetting process
- 3) The operating temperature
- 4) The material strength, especially at high temperatures (heat strength)
- 5) The duration of load application

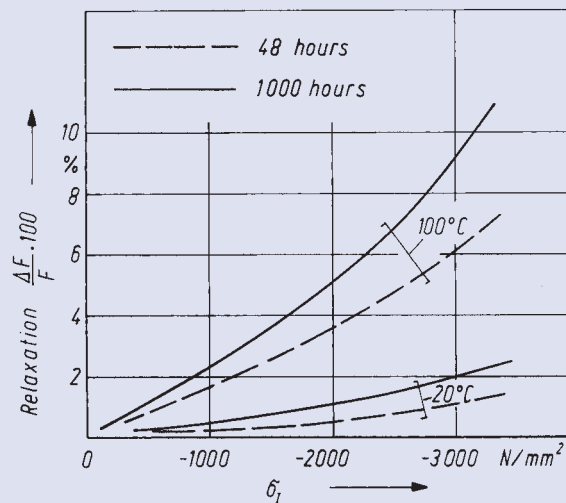

Fig. 3.30: Permissible relaxation for disc springs made of Ck steels (carbon steels) per DIN 17 222

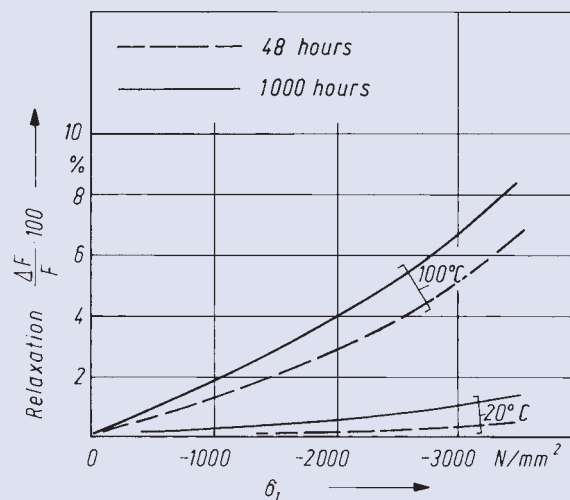

Fig. 3.31: Permissible relaxation for disc springs made of chrome vanadium-alloy steels per DIN 17221 and DIN 17222



Hot-preset springs have approximately the same residual stresses at the surface as cold-preset springs. However, the zone of plasticity extends more deeply into the material, and therefore the slope of the residual stress is less steep. This results in lower set loss when compared with cold-preset springs. The permissible relaxation for cold-preset springs is shown in Fig. 3.30 and 3.31. For operating temperatures higher than 100 °C, please contact Mubea.

### 3.2.7 Friction

Depending upon the spring arrangement, frictional forces arise during the compression and extension of springs between individual springs, between the springs and the guide element, and at the edges of the spring where load is applied. This results in a variation between the calculated characteristic load curve and the actual loading and unloading characteristic load curves for a given application.

#### Friction for an individual disc spring

As shown in Fig. 3.32, during compression frictional forces  $\mu_R \cdot F(\mu_R)$  create a moment that counteracts the moment of the applied load and thus increases the required compression force  $F(\mu_R)$ .

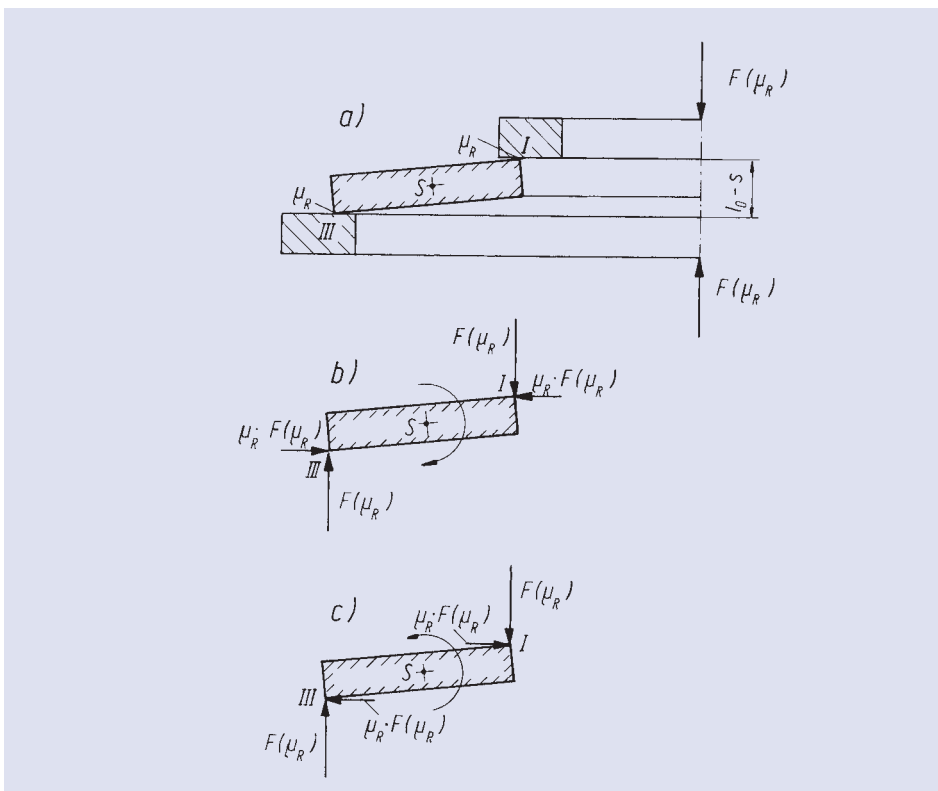

Fig. 3.32 Individual disc spring with edge friction  
 a) Overall view  
 b) Compression  
 c) Extension

During extension, frictional forces create a moment acting in the same direction as the load moment and therefore reduce the required retaining force.

The actual coefficients of friction depend upon the surface finish of the components through which the load is applied, the radii at edges I and III of the disc spring, and the lubricant used.

### Friction in stacks of disc springs arranged in parallel

When a parallel spring stack consisting of  $n$  discs is compressed, radial frictional forces  $\mu_M \cdot F(n, \mu_M)$  acting in opposing directions occur on the surfaces of contacting disc springs (Fig. 3.33). These frictional forces are in addition to those created at the edges where the load is applied to the spring stack. This results in  $n$  frictional moments which counteract the moment of the applied load and thus increase the required compression force. During the release stroke, frictional forces reduce the required retaining force.

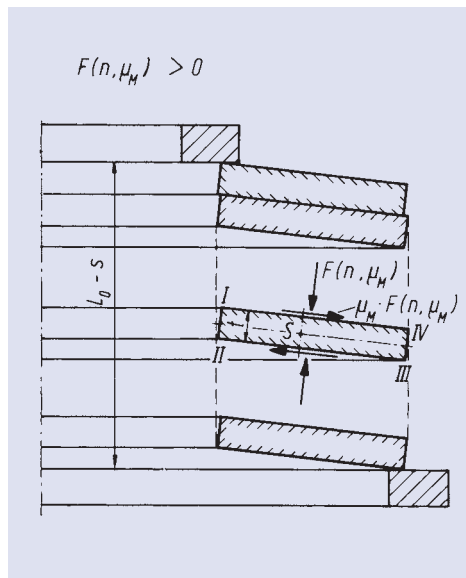

The actual deviation in load is independent of the spring deflection. The use of thicker disc springs (Series A) results in a greater damping effect.

Experience shows that the characteristic load curve deviates more from the characteristic load curve as the numbers of springs arranged in parallel increases (Fig. 3.34). This is due to the accumulation of the geometrical variations of the individual disc springs from their ideal shape, particularly out-of-roundness on the surface area of the cone and deviations in the overall height  $l_0$ .

Abb. 3.33: Friction forces on a parallel stack of disc springs

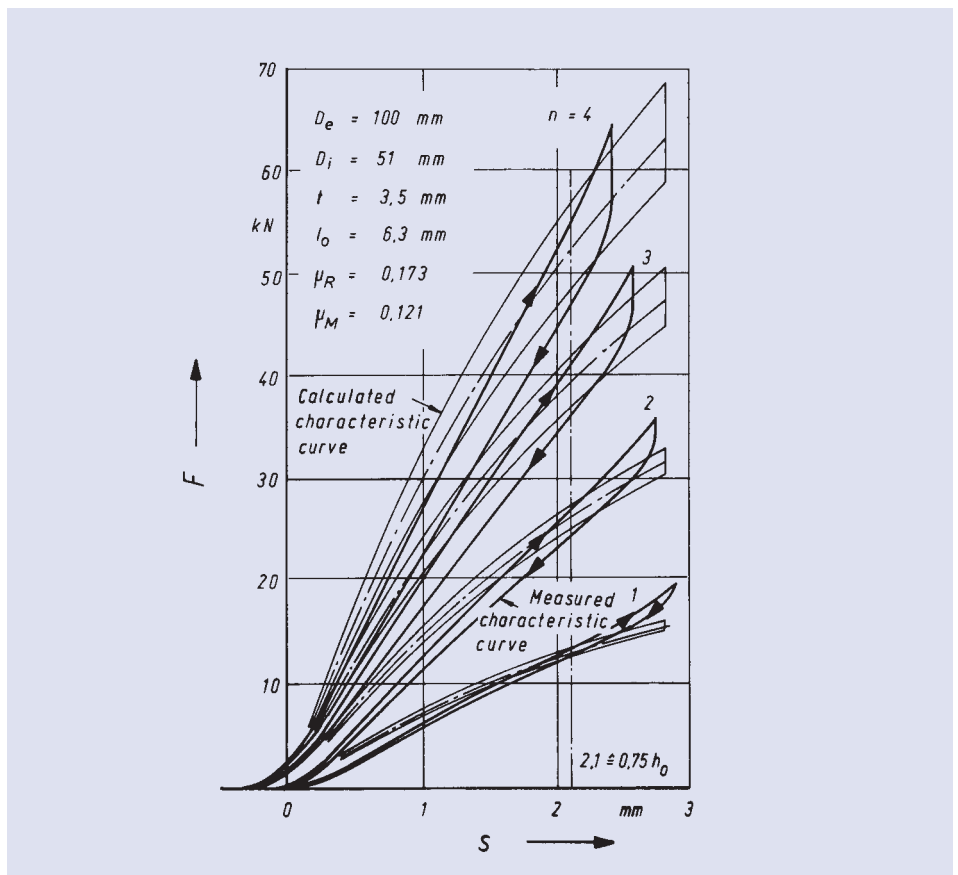

Fig. 3.34: Comparison of measured and calculated characteristics load curves for an individual disc spring and a parallel stack comprised of 2 to 4 disc springs

If springs are moved or even rotated within a stack, slightly different characteristic load curves will occur. In general, however, over time a steady state loading and unloading characteristic curve is established.

For safety reasons, even a single stack of springs arranged in parallel should be provided with internal or external guidance. If disc springs with a low friction design are used, the resulting frictional forces are usually negligible.

### Friction in stacks of disc springs in series

In series spring stacks, it is assumed that disc springs of low friction design are used. For example, the springs are designed with a special inner edge contour that minimises the friction between the guide rod and disc spring stack. This results in the uniform deflection of the disc springs in a stack of individual springs arranged in series. The risk of premature spring fracture from over-stressing the springs at the moving end of the stack is thereby reduced.

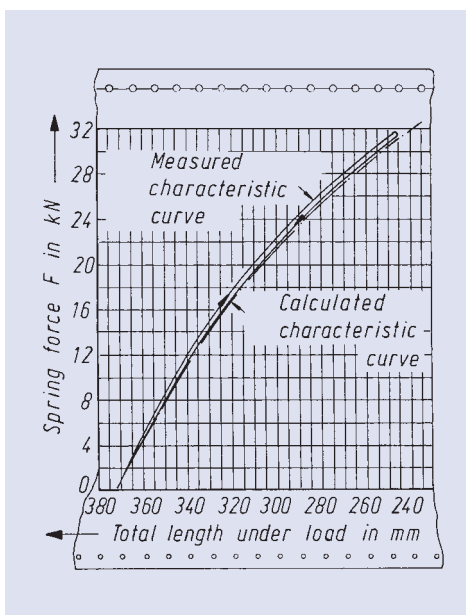
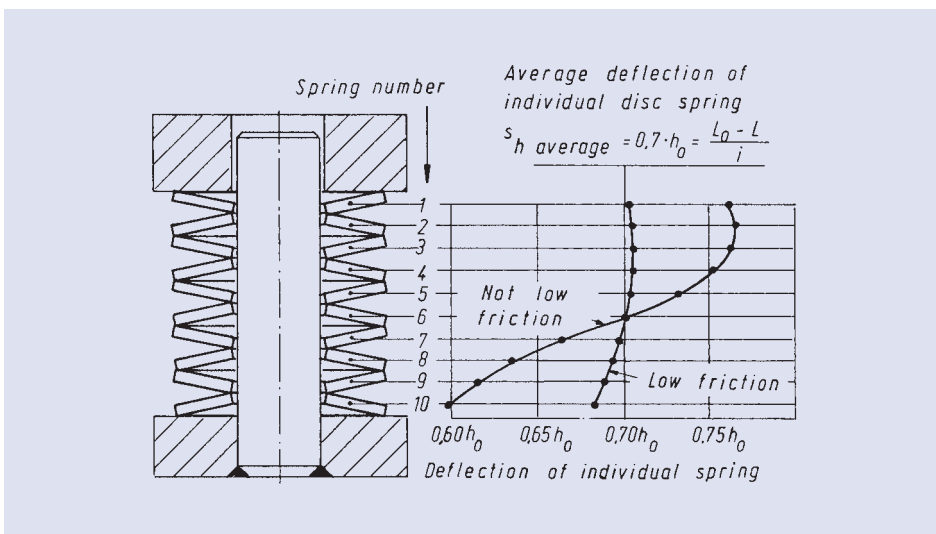

Fig. 3.35 shows the difference in deflection of the individual disc springs in both low friction and high friction spring stacks. The characteristic load curves measured during loading and unloading for series stacks of disc springs of low friction design differ slightly from one another as well as the calculated characteristic load curve (Fig. 3.36). If parallel stacks of disc springs are used in the series stack, these almost ideal conditions no longer apply.

Deviations in the ideal geometry of the individual disc springs result in an uneven transmission of load from one spring to the next in parallel stacks. This results in

Fig. 3.35: Deflection of individual disc springs in a series stack

Ab. 3.36: Comparison between the measured and the calculated characteristic load curves for a spring stack consisting of 10 springs arranged in series

lateral displacement of the springs, which are then pressed with great force against the guide element. If such laterally displaced springs are located at the moving end of the stack, the lateral forces generate a high amount of friction because of the large spring deflection. Therefore, it should be emphasised that the use of parallel stacks of disc springs in a series stack can result in non-uniform deflection of the individual springs and in a higher operating temperature at high frequency. This results in a reduction of the fatigue life of the spring stack.

### 3.3 Symbols, signs, denominations and units

$D_e$	Outside diameter in mm	$\Delta l$	Loss of length due to creep in mm
$D_i$	Inside diameter in mm	N	Number of load cycles prior to failure
$D_o$	Diameter of the circle of inversion in mm	R	Spring rate in N/mm
E	Modulus of elasticity in N/mm <sup>2</sup>	T	Total clearance in mm
F	Spring force for an individual disc spring without contact surfaces in N	W	Spring work in Nmm
$F_1, F_2, F_3$	Spring forces corresponding to the deflections $s_1, s_2, s_3$ in N	$h_o$	Maximum deflection for disc springs without contact surfaces $h_o = l_o - t = s_c$ in mm
$F_c$	Calculated spring force in flat condition in N	i	Number of individual springs or parallel spring stacks in a series spring stack
$F_{tot}$	Spring force for an individual spring with friction or for a parallel or series spring stack in N	$l_o$	Free height of the individual disc spring in mm
$\Delta F$	Decrease in force due to relaxation in N	n	Number of individual disc springs in a parallel spring stack
$L_o$	Length of an unloaded parallel or series spring stack in mm	s	Deflection of the individual disc spring without contact surfaces in mm
$L_1, L_2, L_3$	Assigned lengths of the parallel or series spring stack, corresponding to the loads $F_1, F_2, F_3$ in mm	$s_1, s_2, s_3$	Deflections corresponding to the spring forces $F_1, F_2, F_3$ , in mm
$L_c$	Calculated length of the parallel or series spring stack in the flat condition in mm	$s_{tot}$	Total deflection for the parallel or series spring stack. Recommended max. value: $s_{total} = 0,8 \cdot (L_o - L_c)$ in mm
		t	Thickness of the individual disc spring without contact surfaces in mm

$t'$	Reduced thickness of the individual disc spring with contact surfaces in mm	$\sigma_H$	Calculated stress amplitude $\sigma_H = \sigma_O - \sigma_U$ , corresponding to the working stroke for disc springs subject to dynamic loading in N/mm <sup>2</sup>
$\varphi_O$	Cone angle	$\sigma_O$	Maximum allowable upper stress according to the fatigue strength diagrams in N/mm <sup>2</sup>
$\mu$	POISSON's ratio	$\sigma_U$	Minimum allowable lower stress according to the fatigue strength diagrams in N/mm <sup>2</sup>
$\mu_M, \mu_R$	COULOMB's coefficients of friction	$\sigma_H$	Allowable stress amplitude $\sigma_H = \sigma_O - \sigma_U$ according to the fatigue strength diagrams in N/mm <sup>2</sup>
$P_{\ddot{u}}$	Survival probability	$\sigma_t$	Tangential stress in N/mm <sup>2</sup>
$\sigma$	Calculated stress in N/mm <sup>2</sup>	( )'	All values marked with an ' ie. $F', s', h_o', t', d_e', d_i'$ etc. refer to disc springs with contact surfaces
$\sigma_{max}$	Maximum load stress in N/mm <sup>2</sup>	W	Spring work in Nmm
$\sigma_{Sch}$	Pulsating stress in N/mm <sup>2</sup>		
$\sigma_I, \sigma_{II}, \sigma_{III}, \sigma_{IV}, \sigma_{OM}$	Calculated stresses for the cross-sectional points I,II, III,IV and OM in N/mm <sup>2</sup>		
$\sigma_O$	Calculated maximum allowable stress for disc springs subject to dynamic loading in N/mm <sup>2</sup>		
$\sigma_{Ic}$	Calculated stress at cross-sectional point I in flat position in N/mm <sup>2</sup>		
$\sigma_U$	Calculated minimum required stress for disc springs subject to dynamic loading in N/mm <sup>2</sup>		



# Tolerances





#### **4.1 General tolerances**

#### **4.2 Load testing of disc springs**

- | Individual disc spring

- | Series spring stacks

### 4.1 General tolerances

Tolerances for spring geometry, load, and hardness are specified in Tables 4.1 and 4.2. These tolerances are valid for Mubea's entire product range.

In the case of the springs manufactured per DIN 2093, the tolerances for the outside and inside diameter correspond to  $h_{12}$  or  $H_{12}$ . If tighter tolerances are required, Mubea should be consulted.

	Material thickness $t$ or $t'$	allowable tolerance in material thickness $t$	allowable tolerance in free height $l_0$	allowable tolerance in spring force $F$ at $l_0-s$ during loading with $s = 0.75 h_0$	Hardness
	(mm)	(mm)	(mm)	(%)	(HRC)
Group 1 springs without contact surfaces	0,2 to 0,6	+ 0,02 - 0,06	+ 0,10 - 0,05	+ 25 - 7,5	42-52
	> 0,6 but < 1,25	+ 0,03 - 0,09			
Group 2 springs without contact surfaces	1,25 to 2,0	+ 0,04 - 0,12	+ 0,15 - 0,08	+ 15 - 7,5	
	> 2,0 to 3,0		+ 0,20 - 0,10		
	> 3,0 to 3,8		+ 0,30	+ 10	
	> 3,8 to 6,0	+ 0,05 - 0,15	- 0,15	- 5	
Group 3 springs with contact surfaces	> 6,0 to 15	$\pm 0,10$	$\pm 0,30$	$\pm 5$	
	> 15 to 25	$\pm 0,12$	$\pm 0,50^*$		
	> 25 to 40	$\pm 0,15$	$\pm 1,0^*$		

\* applies only to disc springs with a ratio  $D_e/t \leq 20$

**Table 4.1:**  
Allowable tolerances for material thickness, free height, spring force and spring hardness

When the ratio  $D_e/t > 20$ , a larger tolerance for the free height is typically required. In this case, actual tolerances should be reviewed with Mubea.

Outside diameter $D_e$ , Inside diameter $D_i$			
$D_e$ or $D_i$ (mm)	$D_e h_{12}$ (mm)	Allowable tolerance $D_i H_{12}$ (mm)	Concentricity tolerance for $D_e$ (mm)
3 to 6	0 to -0,12	0 to +0,12	0,15
> 6 to 10	0 to -0,15	0 to +0,15	0,18
> 10 to 18	0 to -0,18	0 to +0,18	0,22
> 18 to 30	0 to -0,21	0 to +0,21	0,26
> 30 to 50	0 to -0,25	0 to +0,25	0,32
> 50 to 80	0 to -0,30	0 to +0,30	0,60
> 80 to 120	0 to -0,35	0 to +0,35	0,70
> 120 to 180	0 to -0,40	0 to +0,40	0,80
> 180 to 250	0 to -0,46	0 to +0,46	0,92
> 250 to 315	0 to -0,52	0 to +0,52	1,04
> 315 to 400	0 to -0,57	0 to +0,57	1,14
> 400 to 500	0 to -0,63	0 to +0,63	1,26
> 500 to 600	0 to -0,68	0 to +0,68	1,36

**Table 4.2:**  
Allowable tolerances for spring diameters and concentricity

## 4.2 Load testing of disc springs

### Individual disc spring

Unless otherwise agreed, the static load  $F$  of an individual spring is checked at a deflection  $l = 0,75 \cdot h_0$ .

Typically, testing is performed while the spring is being loaded. The plates used to apply the load to the spring must be hardened, ground, polished and lightly oiled. For most applications, the allowable deviation from the rated force  $F$  ( $0,75 h_0$ ) as noted in table 4.1 is acceptable. If tighter load tolerances are required, Mubea should be consulted. For diameter ratios less than  $D_e/D_i \sim 1.8$  (special size), load tolerances higher than those given in Table 4.1 are required. For non-standard dimensions the load tolerances should be reviewed with Mubea.

### Series spring stacks

The deviation in force between the characteristic loading and unloading curves is tested using a spring stack consisting of 10 individual springs arranged in series. The springs must be assembled on a guide rod as noted in Section 3.2.4.

During the stacking process, the individual springs must be shifted alternately to the left and right on the guide rod. This will create the maximum amount of friction and therefore provide the maximum expected force deviation between the characteristic loading and unloading curves. This does not apply to special sizes for which the center of inversion,  $S$ , is situated below the plane described by the cross section point II. In this case please refer to Patent No. 1 273 267 granted to Mubea. In such cases mutual agreement is required.

The plates used to apply the load to the spring stack must be hardened, ground, polished and lightly oiled.

For load testing, the spring stack must be compressed to at least  $L_0 - 8 \cdot h_0$ . For  $L_0 - 7,5 \cdot h_0$  the spring force measured during unloading must lie within the limits specified in Table 4.3 (Fig. 4.1).

Group	Series		
	A	B	C
1	90,0		85,0
2	92,5		87,5
3	95,0		90,0

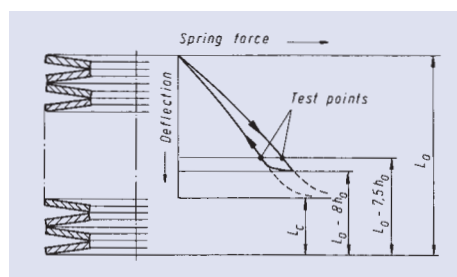

**Table 4.3: Minimum value in percent, of the spring force measured during unloading relative to the force measured during loading**

**Fig. 4.1: Test points on the characteristic loading and unloading curves**



# Materials and Corrosion Protection





## 5.1 Materials

Mubea disc springs are manufactured to meet the most demanding fatigue life requirements while exhibiting a minimum amount of relaxation. The choice of material directly influences these properties. For standard applications, the spring materials Ck 67 and 50 CrV 4 are used. These materials are very economical and commonly used for springs in Group 1 (Ck 67) and in Group 2 and 3 (50 CrV 4). Furthermore, special materials can be used for applications requiring

- | high corrosion resistance
- | operation at low/high temperature
- | antimagnetic properties.

The properties of the materials used by Mubea are listed in the following tables.

In general, it should be noted that the moduli of elasticity provided in Tables 5.1 and 5.3 are experimentally obtained values and are only for reference. However, they do indicate how the spring characteristics will vary as the operating temperature changes. Table 5.2 lists the chemical composition of the various materials used by Mubea.



Application profile	Material designation	DIN Material number	Modulus of elasticity at 20 °C (N/mm <sup>2</sup> )	Max. material thickness (mm)
Standard material	Ck 67 50 CrV 4	1.1231 1.8159 <sup>1)</sup>	206.000 206.000	1,25 25
High material thickness	51 CrMoV 4	1.7701	206.000	40
Corrosion resistant	X 12 CrNi 17 7 <sup>3)</sup> X 7 CrNiAl 17 7 X 5 CrNiMo 18 10	1.4310 1.4568 1.4401	190.000 200.000 190.000	2 2,5 1,6
Thermally stable	X 35 CrMo 17 X 30 WCrV 5 3 X 22 CrMo V 12 1	1.4122 1.2567 1.4923	209.000 206.000 209.000	8 20 8
Antimagnetic and corrosion-resistant	CuBe 2 NiBe 2	2.1247 2.4132	135.000 200.000	3 3
High temperature	Inconel 718 Inconel X 750 Nimonic 90	2.4668 2.4669 2.4969	200.000 214.000 206.000	8 8 8

<sup>1)</sup> Material no. 1.8159 also includes 51 CrV 4 <sup>2)</sup> with hot pre-setting this material may be used at temperatures up to approx. 200° C <sup>3)</sup> Material no. 1.4310 also includes X 10 CrNi 18 8  
\* typically in stock \*\*12–14 weeks, \*\*\*14–16 weeks

Material designation	DIN material number	Chemical composition in percent by mass (reference values)							
		C	Si	Mn	P ≤	S ≤	Cr	Mo	Ni
Ck 67	1.1231	0,69	0,25	0,75	0,035	0,035			
50 CrV 4	1.8159	0,51	0,28	0,90	0,035	0,035	1,05		
51 CrMo 4	1.7701	0,52	0,28	0,90	0,035	0,035	1,05	0,20	
X 12 CrNi 17 7	1.4310	≤ 0,12	≤ 1,0	≤ 2,0	0,045	0,030	17,00		8,00
X 7 CrNiAl 17 7	1.4568	≤ 0,09	≤ 1,0	≤ 1,0	0,045	0,030	17,00		7,13
X 5 CrNiMo 18 10	1.4401	≤ 0,07	≤ 1,0	≤ 2,0	0,045	0,030	17,50	2,25	12,00
X 35 CrMo 17	1.4122	0,38	≤ 1,0	≤ 1,0	0,045	0,030	16,50	1,10	≤ 1,0
X 30 WCrV 5 3	1.2567	0,30	0,25	0,30	0,035	0,035	2,35		
X 22 CrMoV 12 1	1.4923	0,22	0,30	0,50	0,035	0,035	12,00	1,00	0,50
Cu Be 2	2.1247								*
Ni Be 2	2.4132								> 96
Inconel 718 (Ni Cr 19 Nb Mo)	2.4668	0,03	≤ 0,35	≤ 0,35	0,015	0,015	17,00	2,80	50,00
Inconel X 750 (Ni Cr 15 Fe 7 Ti Al)	2.4669	≤ 0,08	≤ 0,5	≤ 1,0			15,50		≤ 70
Nimonic 90 (Ni Cr 20 Co 18 Ti)	2.4969	0,09	≤ 1,0	≤ 1,0		0,015	19,50		Rest

\* = Ni + Co 0,2-0,6%

DIN		International standards			
Material designation	DIN material number	France AFNOR	Great Britain B.S.	Soviet Union GOST	Italy UNI
Ck 67	1.1231	XC 68	060 A 67	70	C 70
50 CrV 4	1.8159	50 CV 4	735 A 50	50ChGFA	50 CrV 4
51 CrMo 4	1.7701	51 CDV 4	-	-	51 CrMoV 4
X 12 CrNi 17 7	1.4310	Z 12 CN 17.07	301 S 21	-	X 12 CrNi 1707
X 7 CrNiAl 17 7	1.4568	Z 8 CNA 17.07	301 S 81	09Ch17N7Ju1	-
X 5 CrNiMo 18 10	1.4401	Z 6 CND 17.11	316 S 16 316 S 31	-	X 5 CrNiMo 1712
X 35 CrMo 17	1.4122	-	-	-	X 35 CrMo 17
X 30 WCrV 5 3	1.2567	-	-	-	-
X 22 CrMoV 12 1	1.4923	-	-	-	X 22 CrMoV 121
Cu Be 2	2.1247	-	-	-	-
Ni Be 2	2.4132	-	-	-	-
Inconel 718 (Ni Cr 19 Nb Mo)	2.4668	-	-	-	-
Inconel X 750 (Ni Cr 15 Fe 7 Ti Al)	2.4669	NC 15 TNbA	HR505	-	-
Nimonic 90 (Ni Cr 20 Co 18 Ti)	2.4969	NC 20 KTA	2HR2 2HR202	-	-

Operating temperature range (°C)	Lead time to obtain raw material	Typical application
-10 to 100 -20 to 150 <sup>2)</sup>	* *	Plant construction, machine tools automotive
-20 to 150	*	Plant construction
-150 to 200 -200 to 200 -200 to 200	* ** ***	Food processing industry, chemical industry
-60 to 300 -60 to 350 -60 to 350	*** *** ***	Boilers, power plant construction, industrial furnaces and ovens, chemical industry
-250 to 150 -200 to 350	*** ***	Electrical equipment, low-temperature applications, superconductors, satellites
-200 to 500 -200 to 500 -200 to 600	** *** ***	Boilers, industrial furnaces and ovens, chemical industry

**Table 5.1: Reference data for disc spring materials**

V	W	Al	Ti	Be	Cu	Co	Fe	Nb
0,15								
0,10								
		1,13						
0,60	4,25							
0,30								
				1,95	Rest	*		
				1,75				
		0,40	0,65		≤ 0,1	≤ 1,0		4,75
		0,70	2,50		≤ 0,5		7,00	0,95
		1,40	2,35		≤ 0,2	16,50	≤ 2,0	

**Table 5.2: Reference values for the chemical composition of various materials**

	Japan JIS	Sweden SS	Spain UNE	USA AISI/SAE
	-	1770	-	1070
	SUP 10	2230	F.1430	6150
	-	-	-	-
	SUS 301	2331	F.3517	301
	SUS 631	2388	-	631
	SUS 316	2347	F.3543 F.3534	316
	-	-	-	-
	-	-	-	-
	-	-	-	-
	-	-	-	-
	-	-	-	-
	-	-	-	-
	-	-	-	AMS 5598A
	-	-	-	AMS 5829

**Table 5.4: Cross-reference table for material designations per DIN and various international standards**

Material designation	DIN material number	Modulus of elasticity (kN/mm <sup>2</sup> ) at							
		20°C	100°C	200°C	300°C	400°C	500°C	600°C	700°C
Ck 67	1.1231	206	202						
50 CrV 4	1.8159	206	202	196					
51 CrMo 4	1.7701	206	202	196					
X 12 CrNi 17 7	1.4310	190	185	178					
X 7 CrNiAl 17 7	1.4568	200	195	190					
X 5 CrNiMo 18 10	1.4401	190	185	178					
X 35 CrMo 17	1.4122	209	205	199	192				
X 30 WCrV 5 3	1.2567	206	202	196	189	178			
X 22 CrMoV 12 1	1.4923	209	205	200	193				
Cu Be 2	2.1247	135	131	126					
Ni Be 2	2.4132	200	195	189	182	176			
Inconel 718 (Ni Cr 19 Nb Mo)	2.4668	200	196	190	186	179	172		
Inconel X 750 (Ni Cr 15 Fe 7 Ti Al)	2.4669	214	207	198	190	179	170		
Nimonic 90 (Ni Cr 20 Co 18 Ti)	2.4969	206	201	195	189	181	175	167	160

**Table 5.3:**  
Effects of temperature on modulus of elasticity (recommended values for design purposes)

Plating process	Coating composition	Coating thickness (µm)	Stability in salt-spray testing per DIN 50 021										
			0	200	400	600	800	1000					
Phosphating	Zinc phosphate + oil	10–15	0	100	200	300	400	500	600	700	800	900	1000
Phosphating	Zinc phosphate + wax	10–40	0	100	200	300	400	500	600	700	800	900	1000
Electro-galvanising	Zinc	> 8	0	100	200	300	400	500	600	700	800	900	1000
Electro-galvanising	Zinc	> 12	0	100	200	300	400	500	600	700	800	900	1000
Electro-galvanising + yellow chromate	Zinc + yellow chromate	> 8	0	100	200	300	400	500	600	700	800	900	1000
Electro-galvanising + yellow chromate	Zinc + yellow chromate	> 12	0	100	200	300	400	500	600	700	800	900	1000
Mech. zinc plating	Zinc	> 12	0	100	200	300	400	500	600	700	800	900	1000
Mech. zinc plating + yellow chromate	Zinc + yellow chromate	> 12	0	100	200	300	400	500	600	700	800	900	1000
Delta Tone	Zinc phosphate + Zinc powder coating	10–15	0	100	200	300	400	500	600	700	800	900	1000
Delta Seal	Zinc phosphate + org. coat + oil	10–15	0	100	200	300	400	500	600	700	800	900	1000
Dacromet 500-A	Chromated zinc flakes	> 5	0	100	200	300	400	500	600	700	800	900	1000
Dacromet 500-B	Chromated zinc flakes	> 8	0	100	200	300	400	500	600	700	800	900	1000
Chem. nickel plating	Nickel	approx. 25	0	100	200	300	400	500	600	700	800	900	1000

**Table 5.5:**  
Comparison of various corrosion prevention processes (recommended values)

### 5.1.1 Standard materials

#### Ck 67 (DIN 1.1231)

Ck 67 is the most economical spring steel for low stress applications. Per DIN 2093, this material is only used for Group 1 springs (material thickness < 1.25 mm). In special cases it may also be used for disc springs with a thickness of up to 4 mm.

#### 50 CrV 4 (DIN 1.8159)

50 CrV 4 is the most commonly used material for disc springs. Because of its high alloy content, it offers the best spring properties in the temperature range of - 15 °C to + 150 °C. If a reduction in durability is acceptable, this material can be used at temperatures down to - 25 °C. With hot-presetting the material may also be used at temperatures up to + 200 °C. It has a lower level of relaxation when compared to non-alloy steels.

#### 51 CrMoV 4 (DIN 1.7701)

51 CrMoV 4 has properties similar to 50 CrV 4. Due to the addition of molybdenum, parts with a material thickness of up to 40 mm can easily be through-hardened. 51 CrMoV 4 also has a higher ductility than 50 CrV 4, making it more suitable for applications with operating temperatures in the range 0 °C to -20 °C.

### 5.1.2 Corrosion-resistant materials

Because of their high nickel alloy content, corrosion-resistant materials have an austenitic crystal lattice in their initial state. In other words, they cannot be martempered or austempered as is done with standard materials. In contrast, corrosion-resistant spring steels obtain their strength by mixed crystal formation, cold working during rolling (see DIN 17 224) and by precipitation hardening (X 7 CrNiAl 17 7). A strength sufficient for springs is achieved only after a certain degree of cold working. Consequently, narrow limits are set for the maximum material thickness of the material. Springs made from corrosion-resistant materials can also be used at extremely low temperatures. However, the strength obtained by cold rolling is lost at temperatures above + 200 °C.

#### X 12 CrNi 17 7 (DIN 1.4310)

X 12 CrNi 17 7 to DIN 17 224 is a chrome-nickel alloy commonly used for corrosion-resistant disc springs. This material obtains its strength by cold rolling. Therefore, the maximum material thickness that can be used for disc springs is limited to 2.0 mm. Cold rolling also magnetises the parts to a certain degree.

#### X 7 CrNiAl 17 7 (DIN 1.4568)

X 7 CrNiAl 17 7 per DIN 17224 is a precipitation-hardened, corrosion-resistant spring steel. It obtains its strength both by cold rolling and by precipitation hardening. X 7 CrNiAl 17 7 steel is highly magnetic in the soft state. Cold working makes the material even more magnetic.

#### X 5 Cr Ni Mo 18 10 (DIN 1.4401)

X 5 Cr Ni Mo 18 10 per DIN 1.4401 is highly corrosion resistant and typically can not be magnetised.

## 5.1.3 Thermally stable materials

Most thermally stable materials are martempered steels. Because of their high alloy content, they exhibit a lower level of creep in the higher temperature ranges when compared with standard materials. The upper operating temperatures stated in Table 5.1 are based on long term exposure to high temperatures. The springs may also be exposed to temperatures around 100 °C higher than those listed for short periods (up to about 1 hour) without affecting their properties. When designing disc springs, it must be kept in mind that the modulus of elasticity decreases as the temperature rises and increases as the temperature falls. Therefore, a disc spring will have a lower force at temperatures above room temperature and a higher force at temperatures below room temperature. For springs manufactured from thermally stable materials premature failure due to brittle-fracture is possible.

### X 35 CrMo 17 (DIN 1.4122)

X 35 CrMo 17 has a high thermal stability due to the addition of molybdenum. This material is also corrosion-resistant when used in some applications. However, its corrosion-resistance is limited at the material strengths required for disc springs. In sea-water or similar environment this material is not corrosion-resistant.

### X 22 CrMoV 12 1 (DIN 1.4923)

This material is a heat-treatable molybdenum and vanadium steel containing thermally stable chrome for applications with operating temperatures of - 60° C to 350° C. X 22 CrMoV 12 1 may fail prematurely due to brittle-fracture.

## 5.1.4 Antimagnetic and corrosion-resistant materials

These materials obtain their strength by precipitation hardening. They are both antimagnetic and corrosion-resistant.

### CuBe 2 (DIN 2.1247)

CuBe 2 is precipitation-hardened copper-beryllium alloy that can be used at extremely low temperatures. Due to its low modulus of elasticity when compared with other materials, springs made of CuBe 2 generate much lower spring forces. CuBe 2 also has good electrical conductivity.

### NiBe 2 (DIN 2.4132)

In addition to the properties mentioned above, NiBe 2 is suitable for use at elevated temperatures. The temperatures listed in Table 5.1 can be exceeded by approx. 100 °C for short periods without affecting the properties of the material.

## 5.1.5 High temperature materials

A number of precipitation-hardenable materials from the group of nickel-base alloys are used for disc springs operating at elevated temperatures. They are highly ductile and have very high fatigue strength. When designing springs made of high temperature materials, the lower tensile strength and unfavourable elastic limit - tensile strength ratio must be taken into account. Otherwise, a high degree of setting loss is possible.

It is not possible to specify an upper operating temperature limit. The overall height of the spring decreases under load due to creep. The actual level of creep is a function of temperature, time and stress. For example, a spring can be used at elevated temperatures if either a lower load is applied or the duration at the elevated temperature is short. Therefore, the values in Table 5.1 can serve only as guide for the maximum temperatures at which the disc springs will exhibit the same behaviour as at room temperature.

It must be kept in mind that the modulus of elasticity is somewhat lower in the upper temperature limit of the material. Taking this into account, disc springs made of thermally stable materials can be used at temperatures up to approx. 150 °C higher than those stated in Table 5.1.

The lead times for thermally stable materials are typically very long. If material is in stock, the delivery times for production orders are the same as for normal steel springs. Nimonic 90 is better suited for extremely high temperatures than Inconel X 750 (or Inconel 718). It should also be noted that thermally stable materials are typically very expensive.

## 5.2 Corrosion protection

Mubea disc springs are capable of withstanding severe loads while operating at very high stress levels. Therefore, suitable measures must be taken to protect the disc spring surfaces from chemical or electrochemical corrosion. There are a variety of coating processes to prevent corrosion. Table 5.5 lists some of the corrosion resistant surface coatings and processes available as well as their relative corrosion resistance when subjected to a salt spray test per the requirements of DIN 50 021.

The values for the coating thickness listed for galvanising and nickel-plating are examples of the protection values attainable. It is also possible in some cases to use a greater coating thickness. In the case of mechanical galvanising and chemical nickel-plating it is possible to obtain a coating thickness up to 50 µm. For disc springs stacked in parallel, there may be problems with the coatings especially on the lateral surfaces of the spring where there is relative motion between the springs. In such cases Mubea should be consulted.

### 5.2.1 Phosphate coatings

#### Zinc phosphate + oiling/waxing

Zinc phosphating and oiling is the standard corrosion protection used for disc springs according to DIN 2093 and Mubea's Factory Standards. During phosphating, fine-crystalline structures of metallic phosphate are deposited on the base metal. A more durable corrosion resistant coating is achieved if an additional protective coating such as oil or wax is applied. Due to production limitations, waxing can only be used on springs with an outside diameter of 100 mm and greater. This type of corrosion prevention is suitable for indoor applications and properly weatherproofed outdoor installations.

#### Manganese phosphate

On request, Mubea can also offer a manganese phosphate coating for disc springs. Manganese phosphate coatings do not offer any corrosion protection. They only serve as a lubricant. A small degree of protection against corrosion can be achieved by oiling prior to transport and storage.

## 5.2.2 Galvanising

When metal coatings are precipitated from aqueous solutions, there is a possibility that hydrogen will diffuse into the surface of the spring. This is particularly the case with the high-strength spring steels used for disc springs. A hydrogen-induced, delayed brittle-fracture (hydrogen embrittlement) may occur. The risk of hydrogen embrittlement can be reduced by a suitable thermal treatment process after galvanising (effusion annealing), but not completely eliminated. Where possible, coatings applied by electrolytic galvanising should be avoided because of the risk of hydrogen embrittlement.

### Electro-galvanising

Zinc is chemically more basic than steel. Zinc protects itself by reacting with the atmosphere to form passive protective coatings. If the zinc coating is damaged, it protects steel cathodically. The level of protection against corrosion is roughly proportional to the thickness of the zinc coating. Additional protection can be provided by adding a chromate finish. Chromate coatings are available in various colours. A subsequent thermal treatment is required to expel the hydrogen. Galvanic coatings are applied mostly for decorative purposes and are used for both indoor and outdoor purposes.

## 5.2.3 Mechanical zinc plating

Mechanical zinc plating offers the same level of corrosion protection as electro-galvanising, but without the risk of hydrogen embrittlement. In the mechanical zinc plating process a zinc powder is applied to the disc spring by the barrelling method. It is recommended that a subsequent chromate coating also be applied. Mechanically zinc-plated springs can be used for same range of applications as for springs that are electro-galvanised.

## 5.2.4 Delta Tone/Delta Seal coating

Delta Tone is an inorganic coating, consisting of zinc and aluminium compounds. Bright silver coatings with high corrosion-preventive properties are obtained through a baking process. The coating is electrically conductive and thus protects the spring against corrosion cathodically. There is no risk of hydrogen embrittlement.

Delta Seal is an organically based coating. A strongly adhesive, chemical-resistant coating is produced after a suitable application and baking process. Delta Seal can also be applied "with internal lubrication" that serves as a long-lasting dry lubrication. Delta Tone and Delta Seal are heavy-metal-free. This high-quality corrosion preventive medium is used mostly to protect springs against corrosion in outdoor applications.

## 5.2.5 Dacromet coating

Dacromet is an inorganic, strongly adhesive coating consisting of zinc and aluminium in a chromate compound. This type of coating offers a high degree of protection against corrosion. It also provides a high heat resistance and a low coefficient of friction with no risk of hydrogen embrittlement.

The Dacromet coating is applied by dip-centrifuging in an aqueous solution of zinc chromate (with a low aluminium content), dried, and subsequently baked. Individual springs

with an outside diameter  $< 40$  mm can sometimes stick together. Dacromet-coated springs are primarily used for outdoor applications requiring a high degree of corrosion protection.

### 5.2.6 Chemical (Electroless) nickel plating

Chemical nickel plating also known as electroless nickel plating is a high quality coating that is wear-resistant and decorative while providing protection against corrosion. Because of the nature of the chemical nickel-plating process, hydrogen embrittlement may occur. The chemical nickel-plating of disc springs is done in dipping units. Nickel-plated disc springs are typically used in applications where they are exposed to high mechanical and chemical stresses.



# Product Range and Characteristic Graphs



## 6.1 The Mubea disc spring product lines

Mubea's standard product lines of disc springs include:

**The Standard Product Range** of disc springs (sizes to DIN 2093 and Mubea Factory Standards) includes 246 sizes with outside diameters between 8 and 250 mm. These springs are manufactured from Ck 67 and 50 CrV 4, and are typically available ex stock (*Table 6.1*; dimensions to DIN 2093 are marked with the corresponding DIN series). The standard corrosion protection is zinc phosphating and oiling.

**The Special Range** of non-standard disc springs includes 153 sizes with outside diameters from 70 to 600 mm (*also shown in Table 6.1*). These springs are typically available ex stock. Production tooling is available for these sizes. The standard corrosion protection is zinc phosphating and oiling.

**The Stainless Steel Product Range** of disc springs made from X 12 Cr Ni 17 7 (Material No. 1.4310) and X 7 Cr Ni Al 17 7 (Material No. 1.4568), are typically available ex stock (*Table 6.2*).

**Disc Springs for Ball Bearings** are available in 68 sizes (*Table 6.3*).

Other sizes and materials are available upon request.

### Ordering informations

Ordering standard springs

Example 1:

100 disc springs with the following dimensions are required

$D_e = 70 \text{ mm}$

$D_i = 30,5 \text{ mm}$

$t = 2,5 \text{ mm}$

Order:

100 disc springs

size 70 x 30,5 x 2,5

Part no. 180 074

Example 2:

200 disc springs are required for pre-loading ball bearings with the designation 6020. The springs are to be located on the outer race of the ball bearing

Order:

200 disc springs

size 149 x 106 x 1,5

Part no. 200 044

### Ordering special sizes

Orders for disc springs with non-standard dimensions should include the following:  $D_e$ ,  $D_i$ ,  $t$ ,  $l_0$  and the required load characteristics. Orders for Group 3 disc springs should also include the value  $t'$ .

## 6.2 Tables of disc spring dimensions

Ref. Nr.	DIN Series	not stocked	Dimensions in mm							Spring deflection $s$ in mm				
										$s = 0,25 h_0$				
			$D_e$	$D_i$	$t$	$t'$	$l_0$	$h_0$	$h_0/t$	$s$	$F$	$\sigma_I$	$\sigma_{II}$	$\sigma_{III}$
17 0001			8,00	3,20	0,30		0,55	0,25	0,833	0,062	45,6	883	207	401
17 0002			8,00	3,20	0,40		0,60	0,20	0,500	0,050	69,2	797	365	350
17 0003			8,00	3,20	0,50		0,70	0,20	0,400	0,050	128,4	943	511	408
17 0004	C		8,00	4,20	0,20		0,45	0,25	1,250	0,062	21,2	696	8	409
17 0005	B		8,00	4,20	0,30		0,55	0,25	0,833	0,062	51,6	872	184	501
17 0006	A		8,00	4,20	0,40		0,60	0,20	0,500	0,050	78,2	784	343	439
17 0007			10,00	3,20	0,30		0,65	0,35	1,166	0,087	51,1	979	90	378
17 0008			10,00	3,20	0,40		0,70	0,30	0,750	0,075	75,1	938	285	348
17 0009			10,00	3,20	0,50		0,85	0,35	0,700	0,087	165,3	1336	447	492
17 0010			10,00	4,20	0,40		0,70	0,30	0,750	0,075	79,3	860	241	405
17 0011			10,00	4,20	0,50		0,75	0,25	0,500	0,062	109,8	789	359	361
17 0012			10,00	4,20	0,60		0,85	0,25	0,416	0,062	181,5	904	473	410
17 0013	C		10,00	5,20	0,25		0,55	0,30	1,200	0,075	30,4	654	21	380
17 0014	B		10,00	5,20	0,40		0,70	0,30	0,750	0,075	87,8	857	224	485
17 0015	A		10,00	5,20	0,50		0,75	0,25	0,500	0,062	121,5	782	343	435
17 0016			12,00	4,20	0,40		0,80	0,40	1,000	0,100	85,1	936	149	385
17 0017			12,00	4,20	0,50		0,90	0,40	0,800	0,100	142,6	1072	285	432
17 0018			12,00	4,20	0,60		1,00	0,40	0,666	0,100	224,1	1208	421	480
17 0019			12,00	5,20	0,50		0,90	0,40	0,800	0,100	150,4	1015	251	493
17 0020			12,00	5,20	0,60		0,95	0,35	0,583	0,087	195,9	957	372	455
17 0021			12,00	6,20	0,50		0,85	0,35	0,700	0,087	133,5	845	249	475
17 0022			12,00	6,20	0,60		0,95	0,35	0,583	0,087	213,6	955	358	531
17 0023	C		12,50	6,20	0,35		0,80	0,45	1,285	0,112	83,5	903	2	506
17 0024	B		12,50	6,20	0,50		0,85	0,35	0,700	0,087	120,0	775	231	420
17 0025	A		12,50	6,20	0,70		1,00	0,30	0,428	0,075	239,4	804	403	425
17 0026			14,00	7,20	0,35		0,80	0,45	1,285	0,112	68,0	723	-11	418
17 0027			14,00	7,20	0,50		0,90	0,40	0,800	0,100	120,1	745	173	419
17 0028			14,00	7,20	0,80		1,10	0,30	0,375	0,075	283,8	712	390	386
17 0029			15,00	5,20	0,40		0,95	0,55	1,375	0,137	101,2	957	3	401
17 0030			15,00	5,20	0,50		1,00	0,50	1,000	0,125	132,8	939	151	383
17 0031			15,00	5,20	0,60		1,05	0,45	0,750	0,112	170,8	908	269	361
17 0032			15,00	5,20	0,70		1,25	0,55	0,785	0,137	340,2	1317	362	526
17 0033			15,00	6,20	0,50		1,00	0,50	1,000	0,125	138,1	895	129	424
17 0034			15,00	6,20	0,60		1,05	0,45	0,750	0,112	177,6	863	243	400
17 0035			15,00	6,20	0,70		1,10	0,40	0,571	0,100	222,4	818	328	373
17 0036			15,00	8,20	0,70		1,10	0,40	0,571	0,100	256,3	819	311	479
17 0037			15,00	8,20	0,80		1,20	0,40	0,500	0,100	366,8	900	391	523
17 0038	C		16,00	8,20	0,40		0,90	0,50	1,250	0,125	83,7	693	10	399
17 0039	B		16,00	8,20	0,60		1,05	0,45	0,750	0,112	172,0	751	197	420
17 0040	A		16,00	8,20	0,90		1,25	0,35	0,388	0,087	362,5	721	386	391
17 0041			18,00	6,20	0,40		1,00	0,60	1,500	0,150	84,6	759	-30	319
17 0042			18,00	6,20	0,50		1,10	0,60	1,200	0,150	129,9	851	61	350
17 0043			18,00	6,20	0,60		1,20	0,60	1,000	0,150	191,1	942	152	382
17 0044			18,00	6,20	0,70		1,40	0,70	1,000	0,175	354,1	1282	207	520
17 0045			18,00	6,20	0,80		1,50	0,70	0,875	0,175	479,5	1388	313	556
17 0046			18,00	8,20	0,70		1,25	0,55	0,785	0,137	254,6	858	216	434
17 0047			18,00	8,20	0,80		1,30	0,50	0,625	0,125	308,9	823	292	411
17 0048			18,00	8,20	1,00		1,50	0,50	0,500	0,125	559,0	963	432	475
17 0049	C		18,00	9,20	0,45		1,05	0,60	1,333	0,150	120,7	763	-14	440
17 0050	B		18,00	9,20	0,70		1,20	0,50	0,714	0,125	233,4	756	216	421
17 0051	A		18,00	9,20	1,00		1,40	0,40	0,400	0,100	450,6	728	382	394
17 0052			20,00	8,20	0,50		1,15	0,65	1,300	0,162	128,3	739	11	355
17 0053			20,00	8,20	0,60		1,30	0,70	1,166	0,175	214,4	907	63	432
17 0054			20,00	8,20	0,70		1,35	0,65	0,928	0,162	261,5	890	161	416
17 0055			20,00	8,20	0,80		1,40	0,60	0,750	0,150	315,0	865	244	398
17 0056			20,00	8,20	0,90		1,50	0,60	0,666	0,150	423,2	934	313	427
17 0057			20,00	8,20	1,00		1,60	0,60	0,600	0,150	555,6	1003	382	455
17 0058			20,00	10,20	0,40		0,90	0,50	1,250	0,125	53,4	443	6	254



Table 6.1

Ref. Nr.	DIN Series	not stocked	Dimensions in mm							Spring deflection s in mm				
										s = 0,25 h <sub>0</sub>				
			D <sub>e</sub>	D <sub>i</sub>	t	t'	l <sub>0</sub>	h <sub>0</sub>	h <sub>0</sub> /t	s	F	σ <sub>I</sub>	σ <sub>II</sub>	σ <sub>III</sub>
17 0059	C		20,00	10,20	0,50		1,15	0,65	1,300	0,162	141,3	734	-4	422
17 0060	B		20,00	10,20	0,80		1,35	0,55	0,687	0,137	304,3	759	230	421
17 0061			20,00	10,20	0,90		1,45	0,55	0,611	0,137	411,7	821	292	452
17 0062			20,00	10,20	1,00		1,55	0,55	0,550	0,137	543,6	882	354	484
17 0063	A		20,00	10,20	1,10		1,55	0,45	0,409	0,112	548,2	733	379	397
17 0064			22,50	11,20	0,60		1,40	0,80	1,330	0,200	240,4	865	-14	488
17 0065			22,50	11,20	0,80		1,45	0,65	0,812	0,162	306,3	751	171	412
18 0001			22,50	11,20	1,25		1,75	0,50	0,400	0,125	693,1	726	383	384
17 0066			23,00	8,20	0,70		1,50	0,80	1,142	0,200	279,4	940	87	397
17 0067			23,00	8,20	0,80		1,55	0,75	0,937	0,187	332,0	925	175	384
17 0068			23,00	8,20	0,90		1,70	0,80	0,888	0,200	485,7	1086	233	449
17 0069			23,00	10,20	0,90		1,65	0,75	0,833	0,187	463,1	944	213	469
17 0070			23,00	10,20	1,00		1,70	0,70	0,700	0,175	538,2	919	282	451
17 0071			23,00	12,20	1,00		1,60	0,60	0,600	0,150	474,7	753	271	429
18 0002			23,00	12,20	1,25		1,85	0,60	0,480	0,150	863,4	881	399	497
18 0003			23,00	12,20	1,50		2,10	0,60	0,400	0,150	1432,0	1009	527	565
17 0072	C		25,00	12,20	0,70		1,60	0,90	1,285	0,255	331,2	902	4	499
17 0073	B		25,00	12,20	0,90		1,60	0,70	0,777	0,175	366,8	724	181	389
18 0004	A		25,00	12,20	1,50		2,05	0,55	0,366	0,137	1040,0	761	425	393
17 0074			28,00	10,20	0,80		1,75	0,95	1,187	0,237	347,9	870	62	375
17 0075			28,00	10,20	1,00		2,00	1,00	1,000	0,250	615,2	1061	165	451
18 0005			28,00	10,20	1,25		2,25	1,00	0,800	0,250	1030,0	1214	319	507
18 0006			28,00	10,20	1,50		2,20	0,70	0,466	0,175	1003,0	863	424	346
17 0076			28,00	12,20	1,00		1,95	0,95	0,950	0,237	589,9	947	156	467
18 0007			28,00	12,20	1,25		2,10	0,85	0,680	0,212	843,8	934	300	451
18 0008			28,00	12,20	1,50		2,25	0,75	0,500	0,187	1149,0	900	406	426
17 0077	C		28,00	14,20	0,80		1,80	1,00	1,250	0,250	434,8	904	13	515
17 0078	B		28,00	14,20	1,00		1,80	0,80	0,800	0,200	476,4	744	174	414
18 0009			28,00	14,20	1,25		2,10	0,85	0,680	0,212	907,4	931	287	513
18 0010	A		28,00	14,20	1,50		2,15	0,65	0,433	0,162	1033,0	747	371	403
17 0079	C		31,50	16,30	0,80		1,85	1,05	1,312	0,262	384,3	771	-9	448
18 0011	B		31,50	16,30	1,25		2,15	0,90	0,720	0,225	790,5	797	224	449
18 0012			31,50	16,30	1,50		2,40	0,90	0,600	0,225	1260,0	899	326	501
18 0013	A		31,50	16,30	1,75		2,45	0,70	0,400	0,175	1391,0	729	382	399
18 0014			31,50	16,30	2,00		2,75	0,75	0,375	0,187	2199,0	879	481	480
17 0080			34,00	12,30	1,00		2,20	1,20	1,200	0,300	587,2	938	63	403
18 0015			34,00	12,30	1,25		2,45	1,20	0,960	0,300	946,4	1063	188	448
18 0016			34,00	12,30	1,50		2,70	1,20	0,800	0,300	1447,0	1188	313	493
18 0017			34,00	14,30	1,25		2,40	1,15	0,920	0,287	912,8	964	177	461
18 0018			34,00	14,30	1,50		2,55	1,05	0,700	0,262	1224,0	953	297	447
18 0019			34,00	16,30	1,50		2,55	1,05	0,700	0,262	1291,0	942	283	495
18 0020			34,00	16,30	2,00		2,85	0,85	0,425	0,212	2097,0	877	445	449
17 0081	C		35,50	18,30	0,90		2,05	1,15	1,277	0,287	457,7	737	2	427
18 0021	B		35,50	18,30	1,25		2,25	1,00	0,800	0,250	730,9	724	168	409
18 0022	A		35,50	18,30	2,00		2,80	0,80	0,400	0,200	1864,0	749	393	409
18 0023			40,00	14,30	1,25		2,65	1,40	1,120	0,350	904,4	961	98	406
18 0024			40,00	14,30	1,50		2,80	1,30	0,866	0,325	1188,0	962	218	398
18 0025			40,00	14,30	1,75		3,05	1,30	0,742	0,325	1722,0	1061	316	433
18 0026			40,00	14,30	2,00		3,05	1,05	0,525	0,262	1800,0	878	393	349
18 0027			40,00	16,30	1,50		2,80	1,30	0,866	0,325	1224,0	928	199	430
18 0028			40,00	16,30	1,75		3,10	1,35	0,771	0,337	1881,0	1076	290	494
18 0029			40,00	16,30	2,00		3,10	1,10	0,550	0,275	1972,0	897	375	402
18 0030			40,00	18,30	2,00		3,15	1,15	0,575	0,287	2182,0	933	365	466
17 0082	C		40,00	20,40	1,00		2,30	1,30	1,300	0,325	565,3	734	-4	422
18 0031	B		40,00	20,40	1,50		2,65	1,15	0,766	0,287	1109,0	774	196	431
18 0032			40,00	20,40	2,00		3,10	1,10	0,550	0,275	2175,0	882	354	484
18 0033	A		40,00	20,40	2,25		3,15	0,90	0,400	0,225	2336,0	746	392	403
18 0034			40,00	20,40	2,50		3,45	0,95	0,380	0,237	3351,0	864	470	466



Table 6.1

Ref. Nr.	DIN Series	not stocked	Dimensions in mm							Spring deflection s in mm				
										s = 0,25 h <sub>0</sub>				
			D <sub>e</sub>	D <sub>i</sub>	t	t'	l <sub>0</sub>	h <sub>0</sub>	h <sub>0</sub> /t	s	F	σ <sub>I</sub>	σ <sub>II</sub>	σ <sub>III</sub>
18 0035	C		45,00	22,40	1,25		2,85	1,60	1,280	0,400	1041,0	883	4	497
18 0036	B		45,00	22,40	1,75		3,05	1,30	0,742	0,325	1524,0	795	214	433
18 0037	A		45,00	22,40	2,50		3,50	1,00	0,400	0,250	2773,0	726	383	384
18 0038			48,00	16,30	1,50		3,00	1,50	1,000	0,375	1048,0	832	135	333
18 0039			50,00	18,40	1,25		2,85	1,60	1,280	0,400	756,9	742	24	325
18 0040			50,00	18,40	1,50		3,15	1,65	1,100	0,412	1166,0	855	93	370
18 0041			50,00	18,40	2,00		3,65	1,65	0,825	0,412	2229,0	1013	251	428
18 0042			50,00	18,40	2,50		4,15	1,65	0,660	0,412	3870,0	1171	409	486
18 0043			50,00	18,40	3,00		4,20	1,20	0,400	0,300	4179,0	891	488	357
18 0044			50,00	20,40	2,00		3,50	1,50	0,750	0,375	1966,0	865	244	397
18 0045			50,00	20,40	2,50		3,85	1,35	0,540	0,337	3008,0	876	373	393
18 0046			50,00	22,40	2,00		3,60	1,60	0,800	0,400	2247,0	932	228	466
18 0047			50,00	22,40	2,50		3,90	1,40	0,560	0,350	3261,0	904	364	442
18 0048	C		50,00	25,40	1,25		2,85	1,60	1,280	0,400	853,7	717	2	410
18 0049			50,00	25,40	1,50		3,10	1,60	1,066	0,400	1242,0	789	74	447
18 0050	B		50,00	25,40	2,00		3,40	1,40	0,700	0,350	1949,0	777	230	430
18 0051			50,00	25,40	2,25		3,75	1,50	0,666	0,375	2905,0	921	292	508
18 0052			50,00	25,40	2,50		3,90	1,40	0,560	0,350	3473,0	903	355	494
18 0053	A		50,00	25,40	3,00		4,10	1,10	0,366	0,275	4255,0	762	424	409
18 0054	C		56,00	28,50	1,50		3,45	1,95	1,300	0,487	1458,0	843	-4	483
18 0055	B		56,00	28,50	2,00		3,60	1,60	0,800	0,400	1910,0	744	173	415
18 0056			56,00	28,50	2,50		4,20	1,70	0,680	0,425	3638,0	931	287	515
18 0057	A		56,00	28,50	3,00		4,30	1,30	0,433	0,325	4142,0	747	371	404
18 0058			60,00	20,50	2,00		4,20	2,20	1,100	0,550	2528,0	1082	125	440
18 0059			60,00	20,50	2,50		4,70	2,20	0,880	0,550	4151,0	1233	276	491
18 0060			60,00	20,50	3,00		5,20	2,20	0,733	0,550	6434,0	1384	426	543
18 0061			60,00	25,50	2,50		4,40	1,90	0,760	0,475	3447,0	949	259	451
18 0062			60,00	25,50	3,00		4,65	1,65	0,550	0,412	4495,0	889	369	414
18 0063			60,00	30,50	2,50		4,50	2,00	0,800	0,500	4059,0	1012	236	564
18 0064			60,00	30,50	2,75		4,75	2,00	0,727	0,500	5125,0	1075	299	596
18 0065			60,00	30,50	3,00		4,70	1,70	0,566	0,425	5083,0	917	356	502
18 0066			60,00	30,50	3,50		5,00	1,50	0,428	0,375	6591,0	874	437	472
18 0067	C		63,00	31,00	1,80		4,15	2,35	1,305	0,587	2364,0	961	-4	536
18 0068	B		63,00	31,00	2,50		4,25	1,75	0,700	0,437	2942,0	763	227	410
18 0069			63,00	31,00	3,00		4,70	1,70	0,566	0,425	4524,0	830	324	441
18 0070	A		63,00	31,00	3,50		4,90	1,40	0,400	0,350	5399,0	726	383	380
18 0071			70,00	24,50	3,00		5,30	2,30	0,766	0,575	5080,0	1070	306	430
18 0072			70,00	24,50	3,50		6,00	2,50	0,714	0,625	8446,0	1324	421	529
18 0073			70,00	25,50	2,00		4,50	2,50	1,250	0,625	2408,0	938	43	406
18 0074			70,00	30,50	2,50		4,90	2,40	0,960	0,600	3755,0	961	153	475
18 0075			70,00	30,50	3,00		5,10	2,10	0,700	0,525	4676,0	895	276	433
18 0076			70,00	35,50	3,00		5,10	2,10	0,700	0,525	5028,0	891	264	493
18 0077			70,00	35,50	3,50		5,30	1,80	0,514	0,450	6077,0	809	347	440
18 0078			70,00	35,50	4,00		5,80	1,80	0,450	0,450	8757,0	891	430	482
18 0079			70,00	35,50	4,00	3,75	5,80	1,80	0,450	0,450	9167,0	977	357	535
18 0080			70,00	40,50	4,00		5,70	1,70	0,425	0,425	9025,0	858	424	521
18 0081			70,00	40,50	4,00	3,75	5,70	1,70	0,425	0,425	9423,0	942	354	579
18 0082			70,00	40,50	5,00		6,40	1,40	0,280	0,350	13646,0	807	513	484
18 0083			70,00	40,50	5,00	4,70	6,40	1,40	0,280	0,350	14004,0	886	457	537
18 0084	C		71,00	36,00	2,00		4,60	2,60	1,300	0,650	2861,0	932	-5	532
18 0085	B		71,00	36,00	2,50		4,50	2,00	0,800	0,500	2894,0	723	169	402
18 0086	A		71,00	36,00	4,00		5,60	1,60	0,400	0,400	7379,0	748	393	402
18 0087			71,00	36,00	4,00	3,75	5,60	1,60	0,400	0,400	7685,0	821	334	447
18 0088			80,00	30,50	2,50		5,30	2,80	1,120	0,700	3664,0	943	91	421
18 0089			80,00	31,00	3,00		5,50	2,50	0,833	0,625	4531,0	890	212	393
18 0090			80,00	31,00	4,00		6,10	2,10	0,525	0,525	7319,0	856	378	366
18 0091			80,00	31,00	4,00	3,75	6,10	2,10	0,525	0,525	7717,0	933	308	406
18 0092			80,00	35,50	4,00		6,20	2,20	0,550	0,550	8118,0	884	364	428





Table 6.1

Ref. Nr.	DIN Series	not stocked	Dimensions in mm							Spring deflection s in mm				
										s = 0,25 h <sub>0</sub>				
			D <sub>e</sub>	D <sub>i</sub>	t	t'	l <sub>0</sub>	h <sub>0</sub>	h <sub>0</sub> /t	s	F	σ <sub>I</sub>	σ <sub>II</sub>	σ <sub>III</sub>
18 0093			80,00	35,50	4,00	3,75	6,20	2,20	0,550	0,550	8577,0	964	289	474
18 0094			80,00	36,00	3,00		5,70	2,70	0,900	0,675	5401,0	964	181	487
18 0095	C		80,00	41,00	2,25		5,20	2,95	1,311	0,737	3698,0	942	-9	544
18 0096	B		80,00	41,00	3,00		5,30	2,30	0,766	0,575	4450,0	774	196	434
18 0097			80,00	41,00	4,00		6,20	2,20	0,550	0,550	8726,0	883	354	486
18 0098			80,00	41,00	4,00	3,75	6,20	2,20	0,550	0,550	9220,0	965	278	538
18 0099	A		80,00	41,00	5,00		6,70	1,70	0,340	0,425	11821,0	755	439	407
18 0100			80,00	41,00	5,00	4,70	6,70	1,70	0,340	0,425	12211,0	827	385	452
18 0101	C		90,00	46,00	2,50		5,70	3,20	1,280	0,800	4232,0	886	2	509
18 0102	B		90,00	46,00	3,50		6,00	2,50	0,714	0,625	5836,0	756	216	421
18 0103	A		90,00	46,00	5,00		7,00	2,00	0,400	0,500	11267,0	728	382	394
18 0104			90,00	46,00	5,00	4,70	7,00	2,00	0,400	0,500	11713,0	796	327	437
18 0105			100,00	41,00	4,00		7,20	3,20	0,800	0,800	8715,0	944	238	437
18 0106			100,00	41,00	4,00	3,80	7,20	3,20	0,800	0,800	9215,0	1004	173	470
18 0107			100,00	41,00	5,00		7,75	2,75	0,550	0,687	12345,0	896	374	404
18 0108			100,00	41,00	5,00	4,70	7,75	2,75	0,550	0,687	13013,0	973	303	446
18 0109	C		100,00	51,00	2,70		6,20	3,50	1,296	0,875	4779,0	853	-3	490
18 0110	B		100,00	51,00	3,50		6,30	2,80	0,800	0,700	5624,0	715	167	399
18 0111			100,00	51,00	4,00		7,00	3,00	0,750	0,750	8673,0	854	225	476
18 0112			100,00	51,00	4,00	3,80	7,00	3,00	0,750	0,750	9156,0	912	165	513
18 0113			100,00	51,00	5,00		7,80	2,80	0,560	0,700	13924,0	903	355	496
18 0114			100,00	51,00	5,00	4,70	7,80	2,80	0,560	0,700	14689,0	983	281	546
18 0115	A		100,00	51,00	6,00		8,20	2,20	0,366	0,550	17061,0	763	424	411
18 0116			100,00	51,00	6,00	5,60	8,20	2,20	0,366	0,550	17753,0	843	361	461
19 0001			100,00	51,00	7,00	6,55	9,20	2,20	0,314	0,550	27374,0	950	457	516
18 0117	C		112,00	57,00	3,00		6,90	3,90	1,300	0,975	5834,0	843	-4	483
18 0118	B		112,00	57,00	4,00		7,20	3,20	0,800	0,800	7639,0	744	173	415
18 0119			112,00	57,00	4,00	3,75	7,20	3,20	0,800	0,800	8192,0	805	107	454
18 0120	A		112,00	57,00	6,00		8,50	2,50	0,416	0,625	15800,0	712	363	384
18 0121			112,00	57,00	6,00	5,60	8,50	2,50	0,416	0,625	16536,0	786	302	431
18 0122			125,00	51,00	4,00		8,50	4,50	1,125	1,125	10096,0	980	86	463
18 0123			125,00	51,00	4,00	3,80	8,50	4,50	1,125	1,125	10705,0	1031	19	492
18 0124			125,00	51,00	5,00		8,90	3,90	0,780	0,975	13063,0	913	241	420
18 0125			125,00	51,00	5,00	4,75	8,90	3,90	0,780	0,975	13804,0	972	179	452
18 0126			125,00	51,00	6,00		9,40	3,40	0,566	0,850	17027,0	859	349	386
18 0127			125,00	51,00	6,00	5,65	9,40	3,40	0,566	0,850	17944,0	931	282	426
18 0128			125,00	61,00	5,00		9,00	4,00	0,800	1,000	14615,0	930	220	500
18 0129			125,00	61,00	5,00	4,75	9,00	4,00	0,800	1,000	15455,0	990	155	538
18 0130			125,00	61,00	6,00		9,60	3,60	0,600	0,900	19789,0	908	334	481
18 0131			125,00	61,00	6,00	5,60	9,60	3,60	0,600	0,900	21079,0	996	249	535
19 0002			125,00	61,00	8,00	7,50	10,90	2,90	0,362	0,725	34434,0	937	415	492
18 0132	C		125,00	64,00	3,50		8,00	4,50	1,285	1,125	8514,0	907	0	522
18 0133	B		125,00	64,00	5,00		8,50	3,50	0,700	0,875	12238,0	778	229	433
18 0134			125,00	64,00	5,00	4,70	8,50	3,50	0,700	0,875	13031,0	842	163	475
18 0135			125,00	64,00	6,00		9,60	3,60	0,600	0,900	20348,0	912	331	504
18 0136			125,00	64,00	6,00	5,60	9,60	3,60	0,600	0,900	21674,0	1000	246	560
19 0003			125,00	64,00	7,00	6,55	10,00	3,00	0,428	0,750	25528,0	886	335	489
19 0004	A		125,00	64,00	8,00	7,50	10,60	2,60	0,325	0,650	31118,0	825	391	450
18 0137			125,00	71,00	6,00		9,30	3,30	0,550	0,825	19538,0	835	328	504
18 0138			125,00	71,00	6,00	5,60	9,30	3,30	0,550	0,825	20725,0	919	250	561
19 0005			125,00	71,00	8,00	7,45	10,90	2,90	0,362	0,725	38416,0	974	408	587
19 0006			125,00	71,00	10,00	9,30	11,80	1,80	0,180	0,450	42821,0	674	409	398
18 0139	C		140,00	72,00	3,80		8,70	4,90	1,289	1,225	9514,0	856	-2	495
18 0140	B		140,00	72,00	5,00		9,00	4,00	0,800	1,000	12014,0	745	173	419
18 0141			140,00	72,00	5,00	4,70	9,00	4,00	0,800	1,000	12847,0	803	109	457
19 0007	A		140,00	72,00	8,00	7,50	11,20	3,20	0,400	0,800	31903,0	846	343	467
18 0142			150,00	61,00	5,00		10,30	5,30	1,060	1,325	15292,0	976	114	458
18 0143			150,00	61,00	5,00	4,75	10,30	5,30	1,060	1,325	16221,0	1029	48	488



Table 6.1

Ref. Nr.	DIN Series	not stocked	Dimensions in mm							Spring deflection s in mm				
										s = 0,25 h <sub>0</sub>				
			D <sub>e</sub>	D <sub>i</sub>	t	t'	l <sub>0</sub>	h <sub>0</sub>	h <sub>0</sub> /t	s	F	σ <sub>I</sub>	σ <sub>II</sub>	σ <sub>III</sub>
18 0144			150,00	61,00	6,00		10,80	4,80	0,800	1,200	19560,0	946	239	435
18 0145			150,00	61,00	6,00	5,70	10,80	4,80	0,800	1,200	20684,0	1006	174	463
19 0008			150,00	61,00	7,00	6,55	11,80	4,80	0,685	1,200	30593,0	1135	245	525
18 0146			150,00	71,00	6,00		10,85	4,85	0,808	1,212	21067,0	943	221	494
18 0147			150,00	71,00	6,00	5,60	10,85	4,85	0,808	1,212	22703,0	1023	131	544
19 0009			150,00	71,00	8,00	7,50	12,05	4,05	0,506	1,012	35885,0	983	321	510
19 0010			150,00	81,00	8,00	7,50	12,00	4,00	0,500	1,000	38230,0	982	315	572
19 0011			150,00	81,00	10,00	9,40	13,40	3,40	0,340	0,850	57601,0	950	438	544
18 0148	C		160,00	82,00	4,30		9,90	5,60	1,302	1,400	12162,0	852	-6	491
18 0149			160,00	82,00	4,30	4,15	9,90	5,60	1,302	1,400	12653,0	880	-45	510
18 0150	B		160,00	82,00	6,00		10,50	4,50	0,750	1,125	17203,0	751	197	420
18 0151			160,00	82,00	6,00	5,60	10,50	4,50	0,750	1,125	18496,0	818	125	464
19 0012	A		160,00	82,00	10,00	9,40	13,50	3,50	0,350	0,875	50547,0	857	390	469
19 0013			160,00	82,00	11,00	10,20	14,50	3,50	0,318	0,875	66678,0	943	434	515
18 0152	C		180,00	92,00	4,80		11,00	6,20	1,291	1,550	14646,0	828	-2	476
18 0153			180,00	92,00	4,80	4,60	11,00	6,20	1,291	1,550	15352,0	861	-48	498
18 0154	B		180,00	92,00	6,00		11,10	5,10	0,850	1,275	16558,0	705	144	396
18 0155			180,00	92,00	6,00	5,60	11,10	5,10	0,850	1,275	17866,0	765	76	435
19 0014	A		180,00	92,00	10,00	9,40	14,00	4,00	0,400	1,000	46850,0	796	327	437
19 0015			180,00	92,00	13,00	12,10	16,50	3,50	0,269	0,875	84574,0	849	438	460
18 0173			200,00	82,00	5,00	4,80	10,50	5,50	1,100	1,375	9700,0	600	26	290
18 0174			200,00	82,00	6,00	5,80	13,00	7,00	1,1767	1,750	22300,0	940	22	450
19 0016			200,00	82,00	8,00	7,50	14,20	6,20	0,775	1,550	35519,0	977	162	458
19 0041		*	200,00	82,00	8,50	8,10	14,50	6,00	0,706	1,500	38500,0	960	220	440
19 0017			200,00	82,00	10,00	9,40	15,50	5,50	0,550	1,375	52053,0	973	303	446
19 0018			200,00	82,00	12,00	11,25	16,60	4,60	0,383	1,150	67868,0	898	393	404
19 0042			200,00	82,00	13,00	12,10	16,50	3,50	0,269	0,875	62100,0	700	370	310
19 0019			200,00	92,00	10,00	9,40	15,60	5,60	0,560	1,400	55657,0	980	289	498
19 0020			200,00	92,00	12,00	11,25	16,80	4,80	0,400	1,200	74572,0	930	385	465
19 0021			200,00	92,00	14,00	13,05	18,10	4,10	0,292	1,025	95817,0	877	441	433
18 0156	C		200,00	102,00	5,50		12,50	7,00	1,272	1,750	19817,0	861	5	494
18 0157			200,00	102,00	5,50	5,30	12,50	7,00	1,272	1,750	20659,0	892	-37	514
19 0022	B		200,00	102,00	8,00	7,50	13,60	5,60	0,700	1,400	33367,0	845	160	475
19 0043		*	200,00	102,00	8,30	7,80	14,30	6,00	0,723	1,500	40500,0	950	170	530
19 0044		*	200,00	102,00	9,00	8,60	14,60	5,60	0,622	1,400	44100,0	890	240	500
19 0023			200,00	102,00	10,00	9,40	15,60	5,60	0,560	1,400	58756,0	983	281	546
19 0045		*	200,00	102,00	11,00	10,30	15,00	4,00	0,364	1,000	49500,0	700	300	380
19 0024	A		200,00	102,00	12,00	11,25	16,20	4,20	0,350	1,050	66983,0	792	357	432
19 0025			200,00	102,00	14,00	13,05	18,20	4,20	0,300	1,050	103986,0	904	441	491
18 0175		*	200,00	112,00	6,00	5,80	12,00	6,00	1,000	1,500	19700,0	770	50	470
19 0026			200,00	112,00	12,00	11,25	16,20	4,20	0,350	1,050	71671,0	809	359	480
19 0027			200,00	112,00	14,00	13,05	17,50	3,50	0,250	0,875	90576,0	745	397	438
19 0046		*	200,00	112,00	15,00	14,00	18,00	3,00	0,200	0,750	93500,0	660	390	390
19 0028			200,00	112,00	16,00	14,80	19,80	3,80	0,237	0,950	146464,0	927	493	545
19 0029	C		225,00	112,00	6,50	6,20	13,60	7,10	1,092	1,775	23582,0	794	15	446
19 0030	B		225,00	112,00	8,00	7,50	14,50	6,50	0,812	1,625	32870,0	812	104	450
19 0047		*	225,00	112,00	9,00	8,45	15,50	6,50	0,722	1,625	43600,0	880	160	480
19 0048		*	225,00	112,00	10,00	9,40	16,20	6,20	0,620	1,550	52800,0	880	220	480
19 0049		*	225,00	112,00	10,80	10,00	16,50	5,70	0,528	1,425	58100,0	850	240	470
19 0031	A		225,00	112,00	12,00	11,25	17,00	5,00	0,416	1,250	64497,0	772	304	415
19 0032			225,00	112,00	16,00	14,90	20,50	4,50	0,281	1,125	128407,0	864	438	458
19 0033			250,00	102,00	10,00	9,40	18,00	8,00	0,800	2,000	58157,0	1017	160	476
19 0034			250,00	102,00	12,00	11,25	19,00	7,00	0,583	1,750	75052,0	971	276	445
19 0035	C		250,00	127,00	7,00	6,70	14,80	7,80	1,114	1,950	26895,0	767	10	438
19 0050		*	250,00	127,00	7,50	7,00	16,50	9,00	1,200	2,250	41900,0	1000	53	580
19 0036			250,00	127,00	8,00	7,50	16,00	8,00	1,000	2,000	38439,0	877	30	500
19 0051		*	250,00	127,00	9,00	8,45	16,60	7,60	0,844	1,900	45900,0	880	98	500
19 0052		*	250,00	127,00	9,20	8,60	17,40	8,20	0,891	2,050	55200,0	990	80	560



Table 6.1

Ref. Nr.	DIN Series	not stocked	Dimensions in mm							Spring deflection s in mm				
										s = 0,25 h <sub>0</sub>				
			D <sub>e</sub>	D <sub>i</sub>	t	t'	l <sub>0</sub>	h <sub>0</sub>	h <sub>0</sub> /t	s	F	σ <sub>I</sub>	σ <sub>II</sub>	σ <sub>III</sub>
19 0037	B		250,00	127,00	10,00	9,40	17,00	7,00	0,700	1,750	51871,0	842	163	471
19 0053		*	250,00	127,00	10,50	9,90	18,00	7,50	0,714	1,875	64800,0	950	180	530
19 0054		*	250,00	127,00	11,00	10,40	18,80	7,80	0,709	1,950	77000,0	1030	200	580
19 0038			250,00	127,00	12,00	11,25	19,30	7,30	0,608	1,825	87633,0	1011	251	563
19 0055		*	250,00	127,00	13,00	12,20	19,60	6,60	0,508	1,650	93900,0	940	300	520
19 0056		*	250,00	127,00	13,50	12,60	19,60	6,10	0,452	1,525	94200,0	880	310	480
19 0039	A		250,00	127,00	14,00	13,10	19,60	5,60	0,400	1,400	93239,0	813	328	444
19 0057		*	250,00	127,00	14,50	13,60	20,00	5,50	0,379	1,375	100400,0	820	350	440
19 0058		*	250,00	127,00	15,00	14,10	21,00	6,00	0,400	1,500	122500,0	930	380	510
19 0040			250,00	127,00	16,00	14,90	21,80	5,80	0,362	1,450	141529,0	949	406	517
19 0059		*	250,00	127,00	16,80	15,65	22,00	5,20	0,310	1,300	142800,0	870	410	470
19 0060		*	250,00	127,00	17,50	16,35	22,00	4,50	0,257	1,125	136000,0	750	400	400
19 0061		*	250,00	127,00	18,50	17,30	23,00	4,50	0,243	1,125	159700,0	790	440	420
19 0062		*	270,00	127,00	10,65	10,00	18,00	7,35	0,690	1,838	53800,0	800	160	420
19 0063		*	270,00	142,00	22,00		26,90	4,90	0,223	1,225	248700,0	780	550	430
19 0064		*	280,00	127,00	12,00	11,40	21,40	9,40	0,783	2,350	95400,0	1110	190	560
19 0065		*	280,00	127,00	19,00	18,00	25,00	6,00	0,316	1,500	178200,0	880	450	430
19 0066		*	280,00	142,00	12,00	11,30	21,00	9,00	0,750	2,250	95100,0	1060	180	590
19 0067		*	280,00	142,00	15,00	14,10	21,40	6,40	0,427	1,600	105700,0	800	310	440
19 0068		*	280,00	142,00	16,60	15,60	23,25	6,65	0,401	1,663	146600,0	910	370	490
19 0069		*	280,00	142,00	17,45	16,40	23,90	6,45	0,370	1,613	162300,0	910	400	490
19 0070		*	280,00	142,00	18,00	16,90	24,00	6,00	0,333	1,500	162600,0	860	400	460
19 0071		*	280,00	142,00	18,90	17,80	24,60	5,70	0,302	1,425	175800,0	830	420	450
19 0072		*	280,00	142,00	20,30	19,10	25,40	5,10	0,251	1,275	190600,0	780	430	420
19 0073		*	280,00	142,00	22,00	20,65	26,35	4,35	0,198	1,088	202800,0	700	430	370
19 0074		*	280,00	152,00	12,80	11,90	19,80	7,00	0,547	1,750	82100,0	820	220	480
19 0075		*	280,00	152,00	15,00	14,00	21,40	6,40	0,427	1,600	111300,0	820	300	480
19 0076		*	280,00	152,00	18,50	17,40	23,60	5,10	0,276	1,275	152700,0	730	380	420
19 0077		*	300,00	127,00	12,00	11,30	21,00	9,00	0,750	2,250	76300,0	930	170	440
19 0078		*	300,00	127,00	13,00	12,30	20,50	7,50	0,577	1,875	70900,0	770	230	360
19 0079		*	300,00	127,00	14,00	13,30	21,00	7,00	0,500	1,750	78300,0	740	270	340
19 0080		*	300,00	127,00	15,30		22,80	7,50	0,490	1,875	104600,0	800	370	370
19 0081		*	300,00	127,00	16,00	15,20	24,30	8,30	0,519	2,075	140200,0	1010	350	470
19 0082		*	300,00	127,00	17,00	16,10	23,80	6,80	0,400	1,700	128400,0	830	360	380
19 0083		*	300,00	127,00	17,40	16,45	22,65	5,25	0,302	1,313	101100,0	620	320	280
19 0084		*	300,00	152,00	8,50	8,25	16,80	8,30	0,976	2,075	31300,0	640	60	360
19 0085		*	300,00	152,00	10,00	9,40	20,00	10,00	1,000	2,500	64900,0	950	40	540
19 0086		*	300,00	152,00	12,00	11,30	21,00	9,00	0,750	2,250	82800,0	920	150	520
19 0087		*	300,00	152,00	13,00	12,20	22,00	9,00	0,692	2,250	101200,0	970	190	540
19 0088		*	300,00	152,00	14,00	13,20	22,00	8,00	0,571	2,000	102500,0	880	250	480
19 0089		*	300,00	152,00	14,50	13,60	22,00	7,50	0,517	1,875	103400,0	830	260	460
19 0090		*	300,00	152,00	15,00	14,10	23,00	8,00	0,533	2,000	123100,0	920	280	510
19 0091		*	300,00	152,00	15,50	14,60	23,50	8,00	0,516	2,000	134100,0	940	300	520
19 0092		*	300,00	152,00	16,10	15,10	23,70	7,60	0,472	1,900	139200,0	910	320	500
19 0093		*	300,00	152,00	16,50		23,00	6,50	0,394	1,625	117500,0	700	370	380
19 0094		*	300,00	152,00	17,00	16,00	24,40	7,40	0,435	1,850	155600,0	920	350	500
19 0095		*	300,00	152,00	18,00	16,80	25,00	7,00	0,389	1,750	170900,0	910	370	490
19 0096		*	300,00	152,00	18,50	17,40	25,00	6,50	0,351	1,625	167900,0	840	380	450
19 0097		*	300,00	152,00	19,50	18,30	26,20	6,70	0,344	1,675	202200,0	910	420	490
19 0098		*	300,00	152,00	20,00	18,80	25,50	5,50	0,275	1,375	173000,0	730	390	390
19 0099		*	300,00	152,00	20,50	19,30	26,50	6,00	0,293	1,500	204700,0	820	420	440
19 0100		*	300,00	182,00	12,00	11,10	18,00	6,00	0,500	1,500	54400,0	590	170	380
19 0101		*	320,00	172,00	8,10	7,60	16,30	8,20	1,012	2,050	26200,0	560	10	340
19 0102		*	320,00	172,00	9,00	8,50	19,00	10,00	1,111	2,500	47000,0	790	10	470
19 0103		*	320,00	172,00	13,00	12,20	20,00	7,00	0,538	1,750	64400,0	620	180	360
19 0104		*	320,00	172,00	15,00	14,10	21,00	6,00	0,400	1,500	77600,0	570	230	330
19 0105		*	340,00	172,00	9,20	8,65	19,40	10,20	1,109	2,550	43700,0	720	10	410
19 0106		*	340,00	172,00	9,50	8,90	20,80	11,30	1,189	2,825	57000,0	850	40	490



Table 6.1

Ref. Nr.	DIN Series	not stocked	Dimensions in mm							Spring deflection s in mm				
										s = 0,25 h <sub>0</sub>				
			D <sub>e</sub>	D <sub>i</sub>	t	t'	l <sub>0</sub>	h <sub>0</sub>	h <sub>0</sub> /t	s	F	σ <sub>I</sub>	σ <sub>II</sub>	σ <sub>III</sub>
19 0107		*	340,00	172,00	10,50	9,90	22,50	12,00	1,143	3,000	78300,0	980	20	560
19 0108		*	340,00	172,00	11,00	10,40	22,40	11,40	1,036	2,850	78300,0	930	30	530
19 0109		*	340,00	172,00	11,50	10,80	22,90	11,40	0,991	2,850	87000,0	970	40	550
19 0110		*	340,00	172,00	12,50	11,80	23,00	10,50	0,840	2,625	90800,0	900	110	510
19 0111		*	340,00	172,00	13,50	12,70	23,50	10,00	0,741	2,500	101300,0	890	150	500
19 0112		*	340,00	172,00	13,70	12,90	24,30	10,60	0,774	2,650	115000,0	970	150	550
19 0113		*	340,00	172,00	14,20	13,30	24,40	10,20	0,718	2,550	118800,0	950	170	530
19 0114		*	340,00	172,00	14,60	13,70	25,10	10,50	0,719	2,625	132700,0	1010	180	560
19 0115		*	340,00	172,00	15,30	14,40	24,70	9,40	0,614	2,350	126200,0	900	220	500
19 0116		*	340,00	172,00	15,80	14,80	25,50	9,70	0,614	2,425	144000,0	960	230	530
19 0117		*	340,00	172,00	16,20	15,20	25,60	9,40	0,580	2,350	146700,0	940	250	520
19 0118		*	340,00	172,00	17,00	16,00	25,30	8,30	0,488	2,075	140300,0	820	280	450
19 0119		*	340,00	172,00	17,30	16,30	26,10	8,80	0,509	2,200	158700,0	900	290	490
19 0120		*	340,00	172,00	18,00	16,90	26,00	8,00	0,444	2,000	156400,0	820	310	450
19 0121		*	340,00	172,00	20,00	18,70	28,00	8,00	0,400	2,000	209500,0	900	360	490
19 0122		*	340,00	172,00	22,00	20,60	28,00	6,00	0,273	1,500	195500,0	690	360	370
19 0123		*	360,00	182,00	15,50	14,60	23,50	8,00	0,516	2,000	93000,0	650	210	360
19 0124		*	360,00	182,00	20,00	18,80	28,30	8,30	0,415	2,075	194800,0	830	330	450
19 0125		*	360,00	182,00	21,00	19,70	28,00	7,00	0,333	1,750	182000,0	700	330	380
19 0126		*	360,00	182,00	21,50	20,20	29,50	8,00	0,372	2,000	227700,0	840	370	460
19 0127		*	360,00	182,00	23,00	21,60	30,20	7,20	0,313	1,800	243300,0	780	380	420
19 0128		*	370,00	202,00	25,00	23,20	31,40	6,40	0,256	1,600	271200,0	710	370	410
19 0129		*	370,00	202,00	26,00	24,20	32,80	6,80	0,262	1,700	324500,0	790	410	450
19 0130		*	380,00	152,00	19,00	18,00	29,00	10,00	0,526	2,500	174600,0	920	310	410
19 0131		*	380,00	192,00	13,50	12,70	26,20	12,70	0,941	3,175	120300,0	990	70	560
19 0132		*	380,00	192,00	25,00	23,40	33,00	8,00	0,320	2,000	313100,0	860	410	460
19 0133		*	380,00	202,00	12,00	11,50	25,00	13,00	1,083	3,250	98100,0	940	20	560
19 0134		*	380,00	202,00	15,00	14,10	27,00	12,00	0,800	3,000	144400,0	990	130	580
19 0135		*	380,00	212,00	18,00	16,70	27,00	9,00	0,500	2,250	158000,0	790	240	480
19 0136		*	400,00	202,00	10,00	9,60	22,00	12,00	1,200	3,000	50100,0	680	10	390
19 0137		*	400,00	202,00	12,00	11,30	26,50	14,50	1,208	3,625	107500,0	1000	40	570
19 0138		*	400,00	202,00	14,00	13,20	27,00	13,00	0,929	3,250	122400,0	940	70	530
19 0139		*	400,00	202,00	16,00	15,10	28,00	12,00	0,750	3,000	146600,0	920	160	510
19 0140		*	400,00	202,00	19,00	17,90	30,00	11,00	0,579	2,750	198900,0	920	260	510
19 0141		*	400,00	202,00	20,30	19,10	31,10	10,80	0,532	2,700	230900,0	950	290	520
19 0142		*	400,00	202,00	21,20	19,90	31,40	10,20	0,481	2,550	240700,0	910	310	500
19 0143		*	400,00	202,00	22,50	21,20	32,50	10,00	0,444	2,500	274900,0	930	350	500
19 0144		*	400,00	202,00	30,00	28,20	37,20	7,20	0,240	1,800	422500,0	790	450	420
19 0145		*	440,00	212,00	18,50		32,00	13,50	0,730	3,375	190400,0	910	250	480
19 0146		*	440,00	252,00	25,00	23,20	33,00	8,00	0,320	2,000	257500,0	670	300	400
19 0147		*	450,00	202,00	25,50	24,00	34,10	8,60	0,337	2,150	241500,0	670	320	330
19 0148		*	450,00	252,00	21,00	19,50	33,00	12,00	0,571	3,000	251200,0	910	230	550
19 0149		*	450,00	252,00	25,00	23,30	33,80	8,80	0,352	2,200	269500,0	700	300	420
19 0150		*	470,00	237,00	33,00	31,00	42,00	9,00	0,273	2,250	516100,0	800	430	430
19 0151		*	480,00	252,00	20,30	19,00	33,00	12,70	0,626	3,175	207400,0	820	190	470
19 0152		*	480,00	252,00	20,70		36,60	15,90	0,768	3,975	285500,0	1030	260	590
19 0153		*	500,00	202,00	37,00	35,00	44,40	7,40	0,200	1,850	466200,0	630	400	270
19 0154		*	500,00	242,00	32,00	30,00	41,00	9,00	0,281	2,250	408400,0	690	360	360
19 0155		*	500,00	252,00	19,00		34,50	15,50	0,816	3,875	200100,0	860	190	480
19 0156		*	600,00	282,00	22,00		44,00	22,00	1,000	5,500	340100,0	1070	140	560
19 0157		*	600,00	282,00	24,00		46,00	22,00	0,917	5,500	413600,0	1120	200	590

\*)  $s_c = h_0 = l_0 - t$  for disc springs without contact surfaces $s_c = h_0 = l_0 - t'$  for disc springs with contact surfaces



Spring force F in N					Stress $\sigma$ in N/mm <sup>2</sup>					$s_c^*$					Weight per 1000 pcs. in kg
$s = 0,50\ ho$					$s = 0,75\ ho$										
s	F	$\sigma_I$	$\sigma_{II}$	$\sigma_{III}$	s	F	$\sigma_I$	$\sigma_{II}$	$\sigma_{III}$	s	F	$\sigma_I$	$\sigma_{II}$	$\sigma_{III}$	
6,000	122200,0	1830	100	1030	9,000	142500,0	2540	350	1420	12,600	150800,0	3210	830	1780	5250,000
5,700	125400,0	1750	180	980	8,550	151000,0	2440	450	1360	12,000	167000,0	3110	940	1710	5520,000
5,700	140300,0	1810	200	1020	8,550	170400,0	2530	490	1410	12,100	191000,0	3250	1020	1790	5730,000
5,250	152500,0	1700	330	950	7,875	194000,0	2390	650	1320	11,200	231400,0	3120	1200	1700	6260,000
5,000	174300,0	1690	400	940	7,500	227600,0	2390	750	1310	10,800	282100,0	3160	1360	1720	6740,000
5,300	196200,0	1840	410	1020	7,950	253900,0	2600	780	1430	11,400	310700,0	3420	1420	1860	6840,000
5,100	205200,0	1800	440	1000	7,650	268900,0	2550	810	1400	11,100	336100,0	3410	1480	1850	7050,000
5,250	229400,0	1910	470	1060	7,875	300900,0	2700	870	1480	11,400	376100,0	3590	1570	1950	7270,000
4,700	224700,0	1700	540	940	7,050	303700,0	2430	930	1320	10,300	396100,0	3290	1630	1770	7640,000
4,850	255900,0	1830	560	1010	7,275	345200,0	2600	980	1420	10,700	450700,0	3540	1730	1910	7850,000
4,700	263200,0	1790	590	980	7,050	358400,0	2550	1020	1390	10,400	474600,0	3480	1780	1870	8060,000
4,150	258300,0	1580	630	860	6,225	360400,0	2270	1050	1230	9,300	496100,0	3160	1790	1690	8490,000
4,400	290800,0	1720	660	940	6,600	403900,0	2460	1110	1330	9,800	550500,0	3410	1900	1820	8640,000
4,000	291000,0	1580	680	860	6,000	409800,0	2280	1110	1230	9,100	577300,0	3230	1910	1720	8960,000
4,000	393500,0	1730	790	940	6,000	558900,0	2500	1280	1340	9,300	809800,0	3630	2230	1920	9920,000
3,000	377900,0	1330	760	710	4,500	550600,0	1950	1190	1030	7,400	869300,0	3020	2130	1590	10900,000
4,000	170000,0	1250	480	680	6,000	235700,0	1800	800	970	8,900	320300,0	2480	1370	1330	8680,000
4,150	365200,0	1600	730	870	6,225	518000,0	2310	1180	1240	9,400	739800,0	3310	2020	1750	11200,000
3,500	347500,0	1370	700	730	5,250	501000,0	1980	1120	1060	8,300	752700,0	2950	1960	1560	11700,000
4,000	431200,0	1630	790	880	6,000	617000,0	2350	1270	1260	9,300	902900,0	3430	2190	1810	12000,000
3,600	466700,0	1520	810	810	5,400	675700,0	2210	1290	1180	8,600	1027000,0	3320	2250	1750	12800,000
3,200	525000,0	1390	780	790	4,800	765700,0	2030	1220	1160	8,200	1252000,0	3260	2290	1840	13700,000
3,400	628000,0	1530	860	880	5,100	915500,0	2240	1350	1270	8,600	1480000,0	3550	2490	2010	14300,000
5,000	319100,0	1760	710	780	7,500	442400,0	2520	1180	1100	11,000	596100,0	3460	1960	1490	13500,000
6,350	196600,0	1850	260	1040	9,525	242400,0	2600	570	1440	13,500	277600,0	3350	1130	1840	8420,000
4,000	599300,0	1660	870	890	6,000	865600,0	2410	1380	1290	9,600	1318000,0	3640	2440	1910	15500,000
6,500	156300,0	1760	170	1040	9,750	187300,0	2450	440	1430	13,500	205700,0	3100	920	1780	7350,000
6,000	244600,0	1860	380	1080	9,000	313900,0	2630	730	1510	12,900	379900,0	3450	1360	1960	9000,000
4,500	288300,0	1520	540	910	6,750	398700,0	2180	920	1290	10,300	551200,0	3070	1650	1800	10200,000
6,000	77900,0	1260	70	710	9,000	90400,0	1750	250	980	12,400	95200,0	2190	560	1210	7050,000
7,250	165400,0	1860	50	1060	10,875	189200,0	2580	290	1450	15,200	194700,0	3250	760	1800	8300,000
6,500	200800,0	1760	260	990	9,750	248900,0	2470	560	1370	13,800	286700,0	3190	1100	1750	9700,000
6,000	252100,0	1735	410	960	9,000	328800,0	2450	770	1350	12,900	406200,0	3240	1390	1750	11100,000
5,500	357700,0	1760	600	960	8,250	488200,0	2510	1020	1360	12,100	645800,0	3420	1760	1830	13200,000
5,400	420300,0	1810	670	990	8,100	580100,0	2590	1120	1400	12,000	783300,0	3570	1930	1910	14000,000
5,100	443500,0	1750	700	950	7,650	619200,0	2510	1160	1360	11,500	857100,0	3520	2000	1880	14600,000
5,000	512000,0	1780	770	960	7,500	722000,0	2560	1270	1380	11,300	1014000,0	3610	2150	1920	15600,000
3,600	822700,0	1540	930	820	5,400	1206000,0	2250	1460	1190	9,000	1945000,0	3570	2620	1860	20700,000
6,750	338500,0	1720	600	900	10,125	458400,0	2440	1040	1270	13,500	564300,0	3060	1570	1570	17000,000
4,000	491700,0	1290	640	780	6,000	708500,0	1870	1030	1120	9,800	1094000,0	2870	1870	1700	18600,000
4,300	461200,0	1300	690	630	6,450	665000,0	1890	1090	900	10,100	991000,0	2800	1880	1320	23900,000
6,000	449800,0	1740	540	1050	9,000	610900,0	2480	940	1480	13,500	814900,0	3430	1700	2030	16700,000
4,400	511400,0	1360	650	800	6,600	733000,0	1970	1050	1160	10,500	1099000,0	2940	1870	1710	20000,000
4,500	999000,0	1560	900	830	6,750	1456000,0	2280	1410	1210	11,000	2282000,0	3520	2490	1840	31500,000
6,350	367200,0	1560	460	890	9,525	493500,0	2220	810	1250	14,000	641300,0	3010	1440	1680	19600,000
7,950	502600,0	1950	630	1110	11,925	674300,0	2760	1100	1550	15,900	823100,0	3460	1690	1930	21300,000
3,700	914900,0	1240	830	530	5,550	1350000,0	1820	1280	770	9,400	2233000,0	2950	2310	1240	45100,000
4,500	788400,0	1350	760	690	6,750	1147000,0	1960	1200	1000	11,000	1794000,0	3030	2120	1520	35400,000
7,750	348100,0	1630	480	900	11,625	461300,0	2310	870	1250	15,500	557200,0	2880	1350	1550	21900,000
11,000	564800,0	2000	420	1050	16,500	712400,0	2810	8201	1450	22,000	821500,0	3480	1360	1780	38000,000
11,000	701300,0	2110	530	1100	16,500	905000,0	2970	990	1530	22,000	1066000,0	3700	1580	1880	41500,000

Ref. Nr.	Dimensions in mm							Spring deflection s in mm						
	D <sub>e</sub>	D <sub>i</sub>	t	t'	l <sub>0</sub>	h <sub>0</sub>	h <sub>0</sub> /t	s = 0,25 h <sub>0</sub>					s = 0,50 h <sub>0</sub>	
								s	F	σ <sub>I</sub>	σ <sub>II</sub>	σ <sub>III</sub>	s	F
171 005	8,0	4,20	0,30		0,50	0,20	0,666	0,05	33,8	593	187	337	0,100	61,0
171 006	8,0	4,20	0,40		0,60	0,20	0,500	0,05	72,2	723	317	405	0,100	136,0
171 014	10,0	5,20	0,40		0,65	0,25	0,625	0,063	61,9	618	213	347	0,125	113,0
171 015	10,0	5,20	0,50		0,70	0,20	0,400	0,05	85,1	545	286	300	0,100	163,3
171 016	12,0	4,20	0,40		0,80	0,40	1,000	0,10	78,6	864	138	355	0,200	130,4
171 017	12,0	4,20	0,50		0,80	0,30	0,600	0,075	85,9	674	265	265	0,150	157,7
171 024	12,5	6,20	0,50		0,85	0,35	0,700	0,088	110,8	715	213	387	0,175	198,4
171 025	12,5	6,20	0,70		0,95	0,25	0,357	0,063	178,0	592	336	310	0,125	344,3
171 027	14,0	7,20	0,50		0,90	0,40	0,800	0,10	110,8	687	160	387	0,200	193,5
171 028	14,0	7,20	0,80		1,10	0,30	0,375	0,075	261,8	656	360	356	0,150	504,7
171 037	15,0	8,20	0,80		1,20	0,40	0,500	0,10	338,3	830	361	482	0,200	635,8
171 039	16,0	8,20	0,60		1,05	0,45	0,750	0,113	158,7	693	182	388	0,225	280,7
171 220	16,0	8,20	0,80		1,20	0,40	0,500	0,10	284,2	720	317	395	0,200	534,1
171 040	16,0	8,20	0,90		1,25	0,35	0,388	0,088	334,4	665	356	360	0,175	642,9
171 050	18,0	9,20	0,70		1,20	0,50	0,714	0,125	215,3	697	199	388	0,250	384,3
171 051	18,0	9,20	1,00		1,40	0,40	0,400	0,10	415,7	671	353	363	0,200	797,5
171 052	20,0	8,20	0,50		1,15	0,65	1,300	0,163	118,4	682	10,2	327	0,325	183,4
171 056	20,0	8,20	0,90		1,50	0,60	0,667	0,15	390,4	861	289	394	0,300	705,2
170 159	20,0	10,20	0,60		1,20	0,60	1,000	0,15	163,3	663	83	375	0,300	271,1
171 060	20,0	10,20	0,80		1,35	0,55	0,687	0,138	280,7	700	212	388	0,275	504,4
170 158	20,0	10,20	0,90		1,40	0,50	0,555	0,125	333,5	668	265	366	0,250	618,8
171 062	20,0	10,20	1,00		1,55	0,55	0,550	0,138	501,5	814	326	446	0,275	931,7
171 063	20,0	10,20	1,10		1,55	0,45	0,409	0,113	506,0	676	350	366	0,225	969,0
171 065	22,5	11,20	0,80		1,45	0,65	0,812	0,163	282,6	693	158	380	0,325	492,0
181 001	22,5	11,20	1,25		1,75	0,50	0,400	0,125	639,3	670	353	354	0,250	1227,0
171 072	25,0	12,20	0,70		1,60	0,90	1,285	0,225	305,5	832	3,5	460	0,450	474,7
171 073	25,0	12,20	0,90		1,60	0,70	0,777	0,175	338,4	668	167	359	0,350	594,3
181 004	25,0	12,20	1,50		2,00	0,50	0,333	0,125	859,4	625	369	322	0,250	1669,0
171 074	28,0	10,20	0,80		1,75	0,95	1,187	0,238	320,9	802	57	346	0,475	509,6
181 005	28,0	10,20	1,25		2,05	0,80	0,640	0,200	679,3	830	301	340	0,400	1235,0
171 078	28,0	14,20	1,00		1,80	0,80	0,800	0,200	439,4	685	160	382	0,400	767,4
181 010	28,0	14,20	1,50		2,15	0,65	0,433	0,163	953,1	689	342	372	0,325	1817,0
181 011	31,5	16,30	1,25		2,15	0,90	0,720	0,225	729,1	735	207	414	0,450	1300,0
181 013	31,5	16,30	1,75		2,45	0,70	0,400	0,175	1283,0	672	353	368	0,350	2462,0
181 021	35,5	18,30	1,25		2,25	1,00	0,800	0,250	674,2	668	155	377	0,500	1178,0
181 031	40,0	20,40	1,50		2,65	1,15	0,768	0,288	1023,0	714	181	398	0,575	1802,0
181 036	45,0	22,40	1,75		3,05	1,30	0,742	0,325	1406,0	733	198	400	0,650	2491,0

\*)  $s_c = h_0 = l_0 - t$  for disc springs without contact surfaces

$s_c = h_0 = l_0 - t'$  for disc springs with contact surfaces

Spring force F in N			Stress in N/mm <sup>2</sup>										Weight per 1000 pcs. in kg	
			s = 0,75 h <sub>0</sub>						s <sub>c</sub> *					
σ <sub>I</sub>	σ <sub>II</sub>	σ <sub>III</sub>	s	F	σ <sub>I</sub>	σ <sub>II</sub>	σ <sub>III</sub>	s	F	σ <sub>I</sub>	σ <sub>II</sub>	σ <sub>III</sub>		
1128	431	636	0,150	83,9	1605	734	897	0,20	105,0	2023	1095	1121	0,087	
1388	691	722	0,150	193,0	1994	1124	1102	0,20	248,0	2543	1615	1393	0,115	
1178	483	656	0,188	156,9	1680	812	928	0,25	197,2	2124	1198	1163	0,181	
1053	608	576	0,150	237,0	1524	968	827	0,20	308,1	1957	1365	1055	0,226	
1624	379	659	0,300	164,5	2280	725	911	0,40	189,7	2832	1174	1112	0,313	
1289	589	502	0,225	220,1	1846	971	710	0,30	277,9	2344	1411	888	0,390	
1359	497	730	0,263	270,7	1930	854	1027	0,35	335,2	2430	1282	1280	0,365	
1148	708	598	0,188	502,6	1667	1117	862	0,25	657,1	2149	1563	1104	0,511	
1299	395	725	0,300	257,5	1835	705	1016	0,40	312,1	2296	1091	1258	0,445	
1270	762	686	0,225	735,0	1842	1206	988	0,30	958,9	2371	1693	1263	0,715	
1593	789	920	0,300	906,0	2289	1284	1312	0,40	1162,6	2918	1846	1660	0,783	
1313	437	729	0,338	378,2	1859	765	1023	0,45	463,6	2333	1166	1270	0,702	
1383	691	753	0,300	761,2	1988	1123	1074	0,40	976,7	2535	1613	1358	0,940	
1286	756	693	0,263	934,2	1862	1200	997	0,35	1217,0	2395	1688	1272	1,060	
1323	469	731	0,375	522,4	1877	811	1028	0,50	645,2	2361	1223	1279	1,040	
1297	751	698	0,300	1157,0	1877	1195	1003	0,40	1505,0	2412	1684	1279	1,485	
1268	116	601	0,488	212,9	1758	318	822	0,65	224,6	2152	617	991	1,030	
1641	659	742	0,450	969,6	2339	1112	1045	0,60	1209,0	2954	1646	1304	1,858	
1244	249	698	0,450	342,0	1741	498	968	0,60	394,4	2156	830	1184	1,101	
1330	494	732	0,413	690,1	1891	846	1031	0,55	856,9	2382	1267	1286	1,470	
1278	588	696	0,375	872,0	1831	968	989	0,50	1109,0	2326	1405	1245	1,650	
1558	722	848	0,413	1315,0	2233	1188	1206	0,55	1674,0	2838	1723	1519	1,840	
1306	746	702	0,338	1403,0	1889	1190	1008	0,45	1823,0	2426	1679	1285	2,020	
1310	392	712	0,488	653,0	1850	703	995	0,65	789,0	2314	1090	1231	1,890	
1294	751	680	0,375	1779,0	1874	1195	977	0,50	2314,0	2408	1684	1245	2,950	
1545	125	847	0,675	553,1	2140	365	1161	0,90	586,1	2617	724	1401	2,070	
1265	406	674	0,525	795,3	1790	716	944	0,70	968,9	2243	1098	1170	2,660	
1213	775	621	0,375	2445,0	1765	1218	897	0,50	3204,0	2281	1696	1151	4,430	
1498	221	638	0,713	610,2	2088	491	876	0,95	666,7	2571	867	1060	3,480	
1584	678	642	0,600	1709,0	2263	1130	906	0,80	2142,0	2866	1658	1131	5,270	
1296	395	715	0,600	1021,0	1832	706	1001	0,80	1238,0	2293	1091	1240	3,610	
1328	734	712	0,488	2620,0	1918	1175	1021	0,65	3394,0	2459	1665	1298	5,420	
1394	488	779	0,675	1764,0	1978	846	1095	0,90	2176,0	2486	1279	1363	5,630	
1299	751	707	0,525	3571,0	1880	1195	1016	0,70	4645,0	2415	1685	1296	7,890	
1263	383	707	0,750	1567,0	1784	685	990	1,00	1899,0	2233	1060	1225	7,180	
1351	437	747	0,863	2418,0	1912	770	1048	1,15	2953,0	2397	1179	1300	11,020	
1390	472	751	0,975	3363,0	1970	823	1055	1,30	4128,0	2473	1250	1311	16,540	

Table 6.2

Ref.Nr.	Dimensions in mm							Spring deflection s in mm							
	D <sub>e</sub>	D <sub>i</sub>	t	t'	l <sub>0</sub>	h <sub>0</sub>	h <sub>0</sub> /t	s = 0,25 h <sub>0</sub>					s = 0,50 h <sub>0</sub>		
								s	F	σ <sub>I</sub>	σ <sub>II</sub>	σ <sub>III</sub>	s	F	
180880	31,5	16,30	1,25		2,00	0,75	0,600	0,188	590,0	606	220	338	0,375	1083,0	
180881	31,5	16,30	1,75		2,30	0,55	0,314	0,138	1023,0	528	320	286	0,275	1992,0	
180882	35,5	18,30	2,00		2,65	0,65	0,325	0,163	1423,0	565	337	306	0,325	2767,0	
180883	40,0	20,40	1,50		2,45	0,95	0,633	0,238	810,8	580	197	320	0,475	1477,0	
180884	40,0	20,40	2,00		2,80	0,80	0,400	0,200	1416,0	572	301	309	0,400	2716,0	
180885	40,0	20,40	2,25		2,95	0,70	0,311	0,175	1698,0	534	326	285	0,350	3308,0	
180886	45,0	22,40	1,75		2,80	1,05	0,600	0,263	1085,0	579	212	312	0,525	1992,0	
180887	45,0	22,40	2,50		3,30	0,80	0,320	0,200	2080,0	537	324	281	0,400	4048,0	
180888	50,0	25,40	1,50		3,10	1,60	1,066	0,400	1206,0	766	72	434	0,800	1969,0	
180889	50,0	25,40	2,00		3,15	1,15	0,575	0,288	1431,0	581	222	318	0,575	2643,0	
180890	50,0	25,40	2,50		3,50	1,00	0,400	0,250	2207,0	572	301	308	0,500	4234,0	
180891	50,0	25,40	3,00		3,85	0,85	0,283	0,213	3088,0	543	347	288	0,425	6043,0	
180892	56,0	28,50	2,00		3,40	1,40	0,700	0,350	1510,0	602	178	333	0,700	2705,0	
180893	56,0	28,50	3,00		4,05	1,05	0,350	0,263	3124,0	558	319	299	0,525	6050,0	
180894	63,0	31,00	2,50		3,95	1,45	0,580	0,363	2186,0	577	220	307	0,725	4033,0	
180895	71,0	36,00	2,50		4,25	1,75	0,700	0,438	2288,0	585	173	323	0,875	4099,0	
180896	80,0	41,00	3,00		4,90	1,90	0,633	0,475	3253,0	581	197	322	0,950	5925,0	

\*)  $s_c = h_0 = l_0 - t$  for disc springs without contact surfaces

$s_c = h_0 = l_0 - t'$  for disc springs with contact surfaces

Spring force F in N			Stress in N/mm <sup>2</sup>										Weight		
			s = 0,75 h <sub>0</sub>						s <sub>c</sub> *						per 1000 pcs.
σ <sub>I</sub>	σ <sub>II</sub>	σ <sub>III</sub>	s	F	σ <sub>I</sub>	σ <sub>II</sub>	σ <sub>III</sub>	s	F	σ <sub>I</sub>	σ <sub>II</sub>	σ <sub>III</sub>	in kg		
1157	495	641	0,563	1512,0	1652	825	907	0,75	1909,0	2093	1210	1139	5,630		
1026	670	553	0,413	2926,0	1494	1049	801	0,55	3841,0	1933	1458	1030	7,89		
1097	706	590	0,488	4058,0	1596	1107	854	0,65	5322,0	2063	1542	1097	11,480		
1106	449	606	0,713	2046,0	1576	756	856	0,95	2568,0	1992	1117	1072	11,020		
1106	640	594	0,600	3940,0	1600	1019	853	0,80	5125,0	2056	1436	1088	14,680		
1037	681	552	0,525	4861,0	1512	1066	799	0,70	6385,0	1956	1481	1028	16,530		
1106	476	592	0,788	2780,0	1581	793	838	1,05	3510,0	2003	1163	1051	16,540		
1044	678	544	0,600	5940,0	1521	1063	787	0,80	7796,0	1967	1479	1011	23,630		
1433	243	804	1,200	2439,0	2001	513	1112	1,60	2761,0	2469	882	1356	17,260		
1110	495	604	0,863	3710,0	1589	820	856	1,15	4704,0	2016	1196	1077	23,020		
1105	640	591	0,750	6141,0	1600	1018	850	1,00	7989,0	2055	1435	1084	28,770		
1058	722	559	0,638	8910,0	1545	1125	812	0,85	11734,0	2004	1556	1047	34,520		
1143	416	628	1,050	3690,0	1623	715	884	1,40	4570,0	2043	1074	1102	28,840		
1081	672	576	0,788	8842,0	1571	1060	832	1,05	11568,0	2026	1481	1066	43,250		
1102	491	582	1,088	5654,0	1577	812	826	1,45	7162,0	2001	1185	1038	46,660		
1110	404	608	1,313	5592,0	1577	695	856	1,75	6925,0	1985	1044	1067	58,090		
1106	449	609	1,425	8210,0	1577	756	861	1,90	10301,0	1993	1117	1078	87,840		

Table 6.3

Ref. Nr.	Dimensions in mm						Spring deflection $s$ in mm    Spring force $F$ in N					
	$D_e$	$D_i$	$t$	$l_0$	$h_0$	$h_0/t$	$s = 0,25 h_0$		$s = 0,50 h_0$		$s = 0,75 h_0$	
							$s$	$F$	$s$	$F$	$s$	$F$
200 001	9,8	6,2	0,2	0,4	0,2	1,000	0,050	11	0,1	18,3	0,150	23,1
200 002	12,8	7,2	0,25	0,5	0,25	1,000	0,062	13,9	0,125	23,2	0,187	29,3
200 003	15,8	8,2	0,25	0,55	0,3	1,200	0,075	12,1	0,150	19,2	0,225	23
200 004	18,8	9,2	0,3	0,65	0,35	1,166	0,087	16,3	0,175	26	0,262	31,3
200 005	18,8	10,2	0,35	0,7	0,35	1,000	0,087	24,2	0,175	40,1	0,262	50,6
200 006	21,8	12,3	0,35	0,75	0,4	1,142	0,100	23,8	0,200	38,2	0,300	46,3
200 007	23,7	14,3	0,4	0,9	0,5	1,250	0,125	43,7	0,250	68,4	0,375	80,6
200 008	25,7	14,3	0,4	0,9	0,5	1,250	0,125	34,4	0,250	53,9	0,375	63,4
200 009	27,7	17,3	0,4	1,0	0,6	1,500	0,150	48,8	0,300	72,7	0,450	80
200 010	29,7	17,4	0,4	1,1	0,7	1,750	0,175	56,2	0,350	80,2	0,525	82,8
200 011	31,7	20,4	0,4	1,1	0,7	1,750	0,175	54,9	0,350	78,5	0,525	81
200 012	34,6	20,4	0,4	1,1	0,7	1,750	0,175	41,6	0,350	59,5	0,525	61,4
200 013	34,6	22,4	0,5	1,2	0,7	1,400	0,175	69	0,350	104,7	0,525	118,3
200 014	36,6	20,4	0,5	1,3	0,8	1,600	0,200	70,3	0,400	102,8	0,600	110,2
200 015	39,6	25,5	0,5	1,3	0,8	1,600	0,200	70,1	0,400	102,5	0,600	109,8
200 016	41,6	25,5	0,5	1,4	0,9	1,800	0,225	78,3	0,450	111	0,675	113,30
200 017	46,5	30,5	0,6	1,5	0,9	1,500	0,225	93,7	0,450	139,5	0,675	153,4
200 018	51,5	35,5	0,6	1,5	0,9	1,500	0,225	82,7	0,450	123,2	0,675	135,4
200 019	54,5	40,5	0,6	1,5	0,9	1,500	0,225	86,3	0,450	128,5	0,675	141,3
200 020	61,5	40,5	0,7	1,8	1,1	1,571	0,275	110,6	0,550	162,7	0,825	175,6
200 021	67,5	50,5	0,7	1,7	1,0	1,428	0,250	95,3	0,500	143,9	0,750	161,2
200 022	71,5	45,5	0,7	2,1	1,4	2,000	0,350	137,4	0,700	189,6	1,050	184,8
200 023	71,5	50,5	0,7	2,1	1,4	2,000	0,350	162,3	0,700	223,9	1,050	218,3
200 024	74,5	55,5	0,8	1,9	1,1	1,375	0,275	121,8	0,550	185,8	0,825	211,2
200 025	79,5	60,5	0,8	2,3	1,5	1,875	0,375	161,8	0,750	226,9	1,125	227,5
200 026	79,5	55,5	0,8	2,3	1,5	1,875	0,375	187,4	0,750	262,7	1,125	263,4
200 027	84,5	60,5	0,9	2,5	1,6	1,777	0,400	246	0,800	349,8	1,200	358,7
200 028	89,5	60,5	0,9	2,5	1,6	1,777	0,400	197,3	0,800	280,6	1,200	287,7
200 029	89,5	65,5	0,9	2,5	1,6	1,777	0,400	229,9	0,800	326,9	1,200	335,2
200 030	94,5	75,5	1,0	2,2	1,2	1,200	0,300	171,8	0,600	272,1	0,900	324,7
200 031	99	65,5	1,0	2,6	1,6	1,600	0,400	186,5	0,800	272,8	1,200	292,3
200 032	99	70,5	1,0	2,6	1,6	1,600	0,400	212	0,800	310,1	1,200	332,2
200 033	109	70,5	1,25	2,7	1,45	1,160	0,362	185,2	0,725	296	1,087	357,1
200 034	109	75,5	1,25	2,7	1,45	1,160	0,362	206,3	0,725	329,7	1,087	397,9
200 035	114	90,5	1,25	2,45	1,2	0,960	0,300	186,1	0,600	312,2	0,900	398,1
200 036	119	75,5	1,25	2,8	1,55	1,240	0,387	172,7	0,775	271,1	1,169	319,9
200 037	119	85,5	1,25	2,8	1,55	1,240	0,387	211,9	0,775	332,7	1,162	392,5
200 038	124	90,5	1,25	3,0	1,75	1,400	0,437	259,4	0,875	393,8	1,312	444,7
200 039	129	85,5	1,25	3,2	1,95	1,560	0,487	254,1	0,975	374,2	1,462	405,1
200 040	129	95,5	1,25	3,2	1,95	1,560	0,487	313,6	0,975	461,9	1,462	500
200 041	139	90,5	1,25	3,25	2,0	1,600	0,500	225,6	1,000	330	1,500	353,6
200 042	139	101	1,25	3,25	2,0	1,600	0,500	273,9	1,000	400,7	1,500	429,3
200 043	149	95,5	1,5	3,2	1,7	1,133	0,425	194,1	0,850	312,1	1,275	379,4
200 044	149	106	1,5	3,2	1,7	1,133	0,425	230,3	0,850	370,4	1,275	450,2
200 045	159	101	1,5	3,5	2,0	1,333	0,500	233	1,000	358,5	1,500	412,2
200 046	159	111	1,5	3,5	2,0	1,333	0,500	269,8	1,000	415	1,500	477,3
200 047	169	111	1,5	3,8	2,3	1,533	0,575	291,5	1,150	431,4	1,725	470,2
200 048	169	121	1,5	3,8	2,3	1,533	0,575	338,6	1,150	501,1	1,725	546,2
200 049	179	121	2,0	4,2	2,2	1,100	0,550	434,5	1,100	704,2	1,650	864
200 050	179	126	2,0	4,2	2,2	1,100	0,550	466,8	1,100	756,5	1,650	928,2
200 051	189	121	2,0	4,3	2,3	1,150	0,575	391,5	1,150	627,2	1,725	758,8
200 052	189	131	2,0	4,3	2,3	1,150	0,575	442,8	1,150	709,4	1,725	858,3
200 053	198	131	2,0	4,5	2,5	1,250	0,625	440,5	1,250	689,9	1,875	811,8
200 054	198	141	2,0	4,5	2,5	1,250	0,625	500,7	1,250	784,2	1,875	922,8
200 055	213	151	2,25	4,5	2,25	1,000	0,562	449,3	1,125	746,1	1,687	941,1

Stress $\sigma$ in N/mm <sup>2</sup>					Weight per 1000 pcs. in kg	Bearings						
s = ho						Dimensions				Bearing Ref. Nr.		
s	F	$\sigma_I$	$\sigma_{II}$	$\sigma_{III}$	d <sub>e</sub>	d <sub>i</sub>						
0,2	26,7	1182	435	787		0,071	10	3				
0,25	33,7	1014	382	608	0,173	13	4			624		
0,3	25	830	252	468	0,281	16	5	4		625	634	
0,35	34,4	808	259	432	0,497	19	6	5		626	635	
0,35	58,4	911	346	529	0,538	19	7			607		
0,4	51,2	819	260	495	0,699	22	8	7		608	627	
0,5	86,3	1055	287	679	0,881	24	9			609		
0,5	68	864	241	518	1,124	26	10	9		6000	629	
0,6	78,9	1018	186	680	1,154	28	12			6001		
0,7	74,7	1060	119	674	1,429	30		10			6200	
0,7	73	993	104	684	1,452	32	15	12		6002	6201	
0,7	55,3	783	88	501	1,926	35			10			6300
0,7	120,8	953	203	655	2,144	35	17	15		6003	6202	
0,8	104,9	939	151	570	2,846	37			12			6301
0,8	104,6	874	130	601	2,830	40		17			6203	
0,9	100,3	903	86	598	3,331	42	20		15	6004		6302
0,9	151,3	848	151	591	4,557	47	25	20	17	6005	6204	6303
0,9	133,6	732	127	532	5,149	52		25	20		6205	6304
0,9	139,4	738	124	572	4,920	55	30			6006		
1,1	168,9	708	110	495	9,244	62	35	30	25	6007	6206	6305
1,0	163	619	118	482	8,657	68	40			6008		
1,4	151,7	720	28	494	13,128	72			30			6306
1,4	179,1	811	24	607	11,057	72		35			6207	
1,1	217,4	624	131	484	12,182	75	45			6009		
1,5	195,8	690	49	472	18,594	80			35			6307
1,5	226,6	766	48	566	15,980	80	50	40		6010	6208	
1,6	320,1	824	72	622	19,309	85		45			6209	
1,6	256,8	679	63	488	24,137	90			40			6308
1,6	299,2	763	65	586	20,641	90	55	50		6011	6210	
1,2	353,4	597	160	491	19,914	95	60			6012		
1,6	278,4	574	84	404	33,975	100			45			6309
1,6	316,4	631	88	473	29,782	100	65	55		6013	6211	
1,45	393,4	464	139	316	53,285	110			50			6310
1,45	438,3	500	147	362	47,632	110	70	60		6014	6212	
1,2	464	466	172	380	37,035	115	75			6015		
1,55	343,9	419	114	281	65,203	120			55			6311
1,55	422	485	127	363	52,795	120		65			6213	
1,75	454	542	110	413	55,377	125	80	70		6016	6214	
1,95	391,3	511	81	360	71,907	130			60			6312
1,95	483	600	89	464	57,959	130	85	75		6017	6215	
2,0	336,8	448	66	311	85,779	140			65			6313
2,0	408,8	517	71	394	70,283	140	90	80		6018	6216	
1,7	421,3	343	107	232	120,968	150			70			6314
1,7	499,9	388	118	288	101,402	150	100	85		6020	6217	
2,0	430,2	374	89	252	139,457	160			75			6315
2,0	498,1	414	95	303	119,851	160	105	90		6021	6218	
2,3	458,5	414	69	289	150,184	170			80			6316
2,3	532,7	463	74	348	128,729	170	110	95		6022	6219	
2,2	968,8	429	138	304	214,549	180			85			6317
2,2	1041	452	144	332	199,321	180	120	100		6024	6220	
2,3	838,5	387	118	261	259,925	190			90			6318
2,3	948,4	421	126	305	228,852	190		105			6221	
2,5	870	407	107	284	271,799	200			95			6319
2,5	988,9	447	115	332	238,260	200	130	110		6026	6222	
2,25	1085,3	360	129	265	313,056	215		120	100		6224	6320

Table 6.3

Ref. Nr.	Dimensions in mm						Spring deflection s in mm    Spring force F in N					
	D <sub>e</sub>	D <sub>i</sub>	t	l <sub>0</sub>	h <sub>0</sub>	h <sub>0</sub> /t	s = 0,25 h <sub>0</sub>		s = 0,50 h <sub>0</sub>		s = 0,75 h <sub>0</sub>	
							s	F	s	F	s	F
200 056	223	161	2,25	4,6	2,35	1,040	0,587	460,5	1,175	756,4	1,762	942,4
200 057	228	161	2,25	4,95	2,7	1,200	0,675	548,4	1,350	868,4	2,025	1036,2
200 058	238	161	2,25	5,25	3,0	1,330	0,750	577	1,500	887,8	2,250	1020,9
200 059	248	171	2,5	5,0	2,5	1,000	0,625	479,7	1,250	796,5	1,875	1004,7
200 060	258	171	2,5	5,5	3,0	1,200	0,750	585,5	1,500	927,2	2,250	1106,4
200 061	268	181	2,5	5,7	3,2	1,280	0,800	636,1	1,600	989,7	2,400	1155
200 062	278	181	2,5	6,0	3,5	1,400	0,875	673,8	1,750	1022,7	2,625	1154,9
200 063	288	191	2,75	5,75	3,0	1,090	0,750	573,2	1,500	931	2,250	1145,2
200 064	298	191	2,75	6,35	3,6	1,310	0,900	730,1	1,800	1128,9	2,700	1306,9
200 065	308	202	3,0	6,1	3,1	1,030	0,775	631,5	1,550	1040,1	2,325	1299,9
200 066	318	212	3,0	6,2	3,2	1,070	0,800	643,7	1,600	1051,5	2,400	1302,1
200 067	338	232	3,0	6,6	3,6	1,200	0,900	748,7	1,800	1185,6	2,700	1414,6
200 068	358	242	3,0	7,2	4,2	1,400	1,050	892	2,100	1353,8	3,150	1528,9



Stress $\sigma$ in N/mm <sup>2</sup>					Weight per 1000 pcs. in kg	Bearings							
s = h <sub>0</sub>						Dimensions			Bearing Ref. Nr.				
s	F	$\sigma_I$	$\sigma_{II}$	$\sigma_{III}$	d <sub>e</sub>	d <sub>i</sub>							
2,35	1073,6	358	121	268		330,257	225	150					
2,7	1127,9	398	111	294	361,538	230		130			6226		
3,0	1065,3	399	93	284	426,180	240			110				6322
2,5	1158,5	315	114	226	497,270	250		140			6228		
3,0	1204,2	355	100	248	575,259	260			120				6324
3,2	1226,1	367	92	261	602,078	270		150			6230		
3,5	1178,9	371	79	256	686,233	280			130				6326
3,0	1287,5	303	99	211	787,747	290		160			6232		
3,6	1374,5	351	86	239	887,100	300			140				6328
3,1	1485,4	290	102	200	999,872	310		170			6234		
3,2	1474,1	289	97	202	1039,083	320		180	150		6236		6330
3,6	1539,7	310	87	223	1117,504	340		190	160		6238		6332
4,2	1560,6	335	70	239	1287,294	360		200			6240		

### 6.3 Explanation of disc spring diagrams

All graphs are based upon a modulus of elasticity of  $E = 2,06 \times 10^5 \text{ N/mm}^2$  and a POISSON ratio of  $\mu = 0,3$ . For simplifying the selection of the proper disc spring, load deflection curves are provided for all standard disc springs. The goal is to provide information to simplify the selection of the proper disc spring. In addition to the dimensioned cross-sectioned drawing of the disc spring, each diagram has a table with pertinent data and specifications for parallel spring stacks.

The following information is plotted on the diagram:

- | the theoretical characteristic load curve  $F(s)$ ,
- | the calculated spring work,  $W(s)$ , due to elastic deformation of the material, and
- | the fatigue strength specifications based upon varying numbers of load cycles.

The fatigue strength specifications apply to spring stacks with up to 10 individual disc springs stacked in series, a sinusoidal compression - time curve, and a survival probability of  $P_{\dot{N}} = 99 \%$ . Disc springs should not be loaded beyond  $s_2 = 0,8 \cdot h_0$  for dynamic applications. Therefore this value is specified as the upper deflection limit, even if higher deflections are theoretically permissible. A lower limit of  $s_1 = 0,15 \cdot h_0$  is specified as the minimum deflection for fatigue strength calculations.

Some springs have a curved line at  $N = 10^5, 5 \cdot 10^5$  or  $2 \cdot 10^6$  load cycles. This is due to the fact that the cross-sectional point that is decisive for the fatigue strength changes depending upon the spring deflection.

Experience shows that the calculated spring characteristic load curve  $F(s)$  deviates from the measured characteristic load curve. If the measurement is taken between two flat plates, higher forces are typically measured for compressions  $s_2 > 0,8 \cdot h_0$ . This deviation is lower for disc springs with contact surfaces, as they have not yet reached the flat condition for the deflection  $S = h_0$  due to their higher cone angle.

#### Example for use of spring diagrams:

A disc spring stack consisting of 10 springs of the size  $100 \times 51 \times 5,0$  is arranged in series and assembled on a guide rod. The stack is subjected to a maximum load of  $F_2 = 29,1 \text{ kN}$  and the stroke length is to be maximised. The following items are to be determined:

- 1) the deflections  $s_1$  and  $s_2$  of the individual spring as well as the deflection for the entire stack
- 2) the spring force,  $F_1$
- 3) the allowable number of load cycles,  $N$

**For item 1)** The maximum deflection,  $h_0 = 2,8 \text{ mm}$ , is taken from the upper table of the diagram for the disc spring of the size  $100 \times 51 \times 5$ .

The minimum preload deflection  $s_u = s_1 = 0,15 h_0 = 0,15 \cdot 2,8 \text{ mm} = 0,42 \text{ mm}$ .

The maximum deflection for  $F_2 = 29,1 \text{ kN}$  is found on the x-axis below Point B;  $s_2 = 1,61 \text{ mm}$ .

The deflection for the entire stack is  $(s_2 - s_1) \cdot 10 = 11,9 \text{ mm}$ .

**For item 2)** From the diagram, the value  $F_1 = 8,6 \text{ kN}$  (Point A) is obtained for  $s_1 = 0,42 \text{ mm}$ .

**For item 3)** From the diagram, the point of intersection, E, is obtained by drawing a vertical line through point A and the horizontal line through point B, the value  $N \approx 5 \cdot 10^5$ , is obtained.

In other words, the disc spring will sustain  $5 \cdot 10^5$  load cycles without failure with a 99 %

## 100 x 51 x 5,0

GR 2

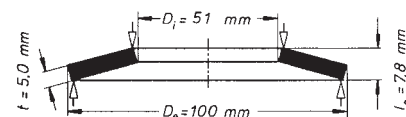

$h_0 = 2.8 \text{ mm}$        $D_e/D_i = 1.96$   
 $t = 5.0 \text{ mm}$        $D_e/t = 20$   
 $h_0/t = 0.56$        $m = 228,081 \text{ g}$

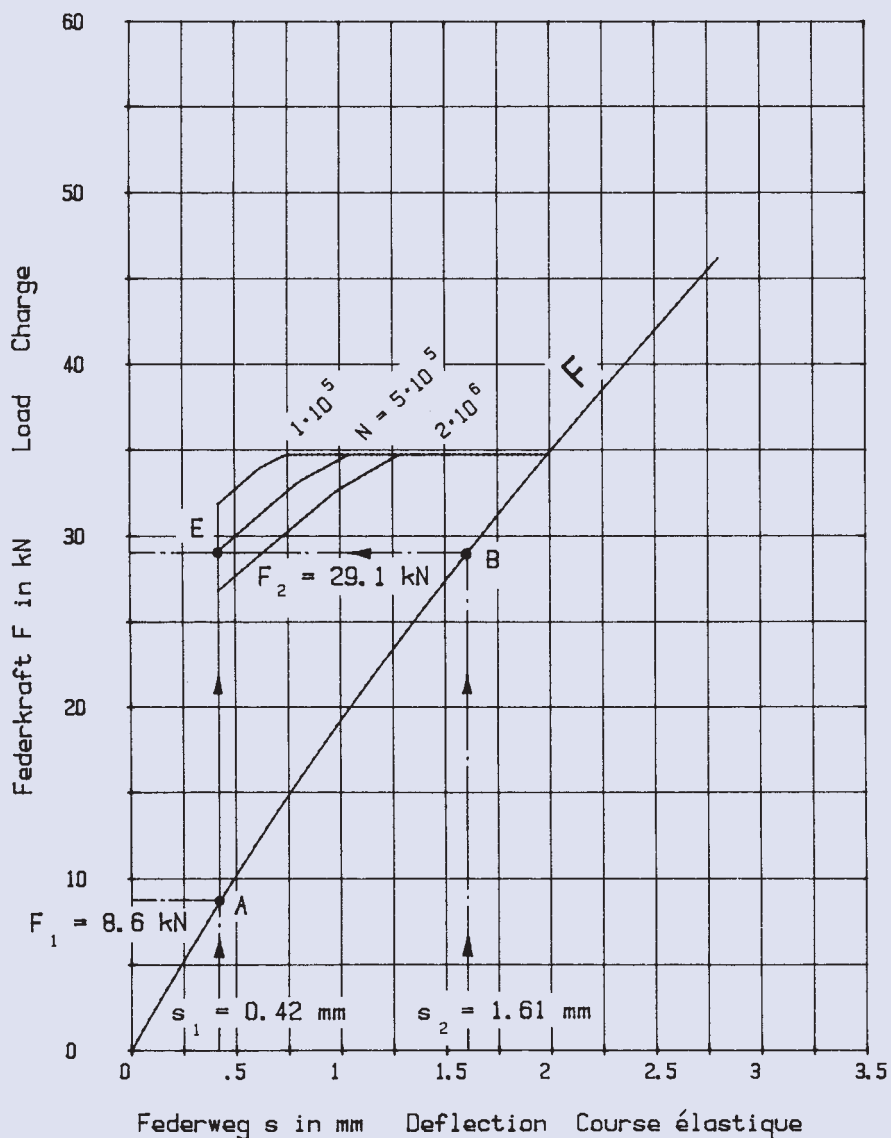
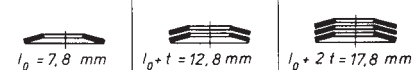

probability. It can also be shown from the diagram that a preload deflection of  $s_1 = 0,64 \text{ mm} = 0,23 \cdot h_0$  is required to achieve the fatigue life of  $N = 2 \cdot 10^6$  load cycles while maintaining a deflection of  $s_2 = 1,61 \text{ mm}$ .

8 x 3,2 x 0,3

GR 1

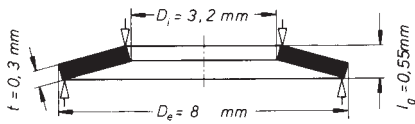

$h_0 = 0,25 \text{ mm}$        $D_e / D_i = 2,5$   
 $t = 0,3 \text{ mm}$        $D_e / t = 26,666$   
 $h_0 / t = 0,833$        $m = 0,099 \text{ g}$

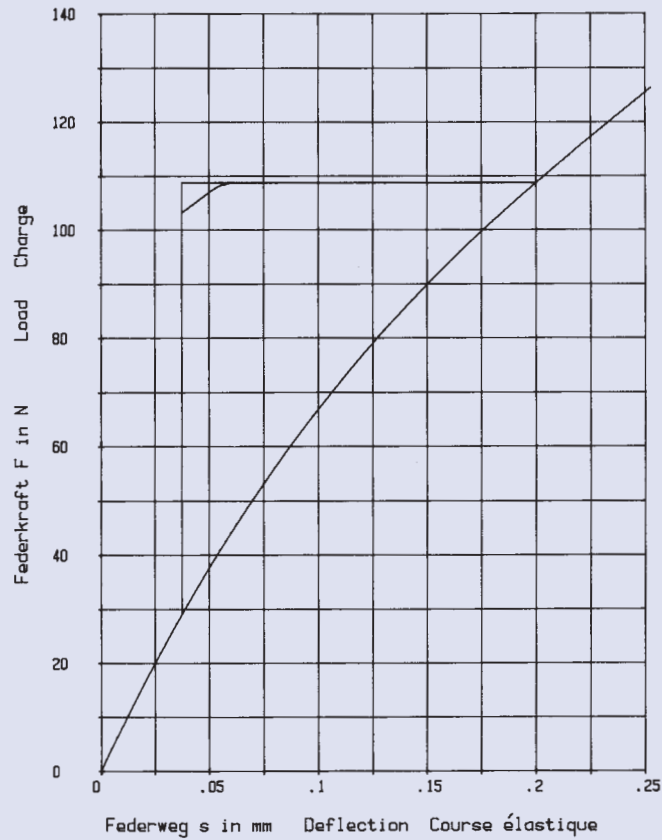
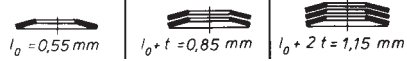

8 x 3,2 x 0,4

GR 1

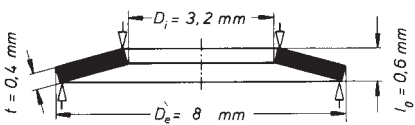

$h_0 = 0,2 \text{ mm}$        $D_e / D_i = 2,5$   
 $t = 0,4 \text{ mm}$        $D_e / t = 20$   
 $h_0 / t = 0,5$        $m = 0,133 \text{ g}$

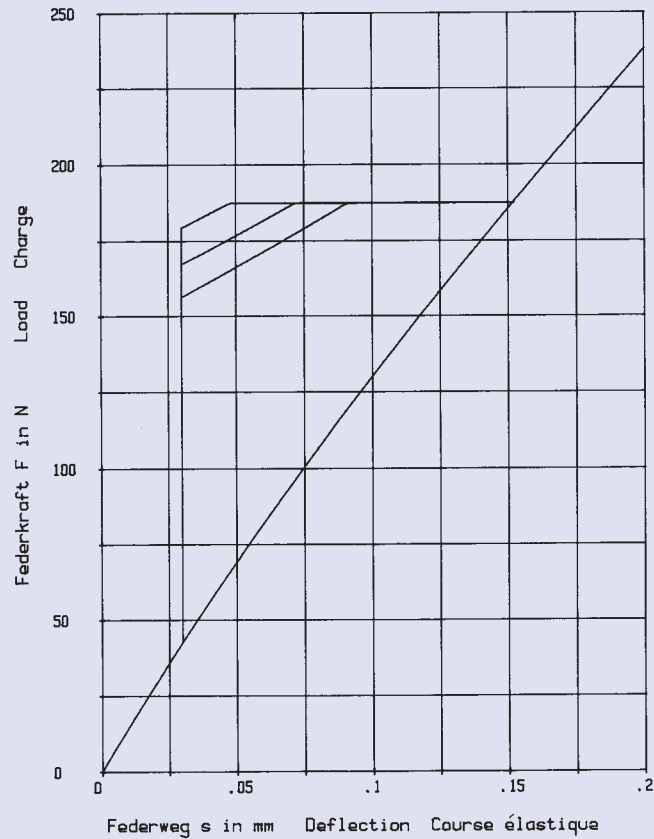
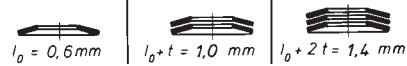

8 x 3,2 x 0,5

GR 1

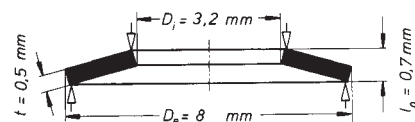
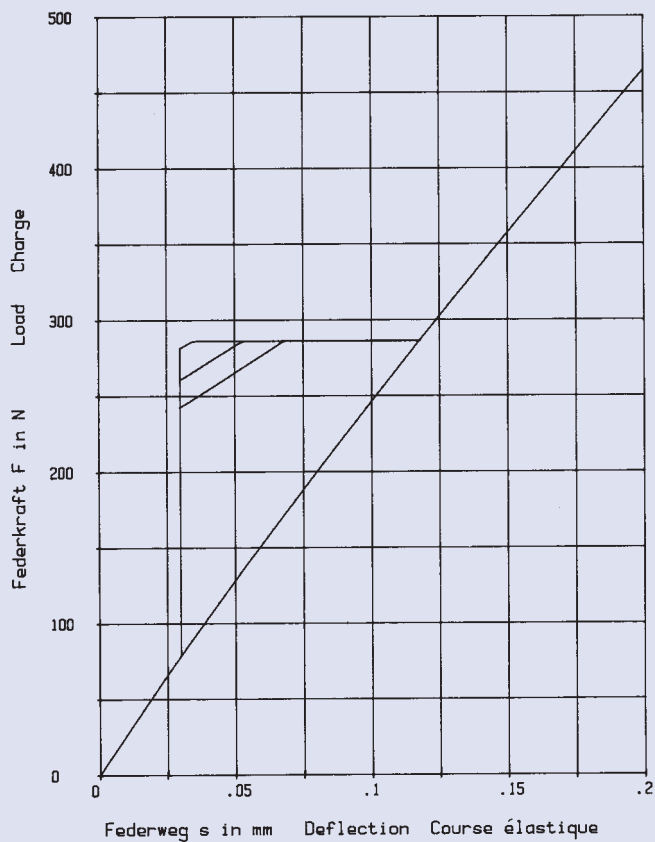

$$\begin{aligned}
 h_0 &= 0,2 \text{ mm} & D_e/D_1 &= 2,5 \\
 t &= 0,5 \text{ mm} & D_e/t &= 16 \\
 h_0/t &= 0,4 & m &= 0,166 \text{ g}
 \end{aligned}$$

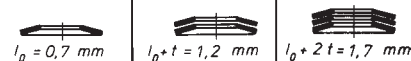

8 x 4,2 x 0,2

GR 1, DIN 2093 – C 8

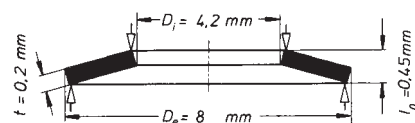
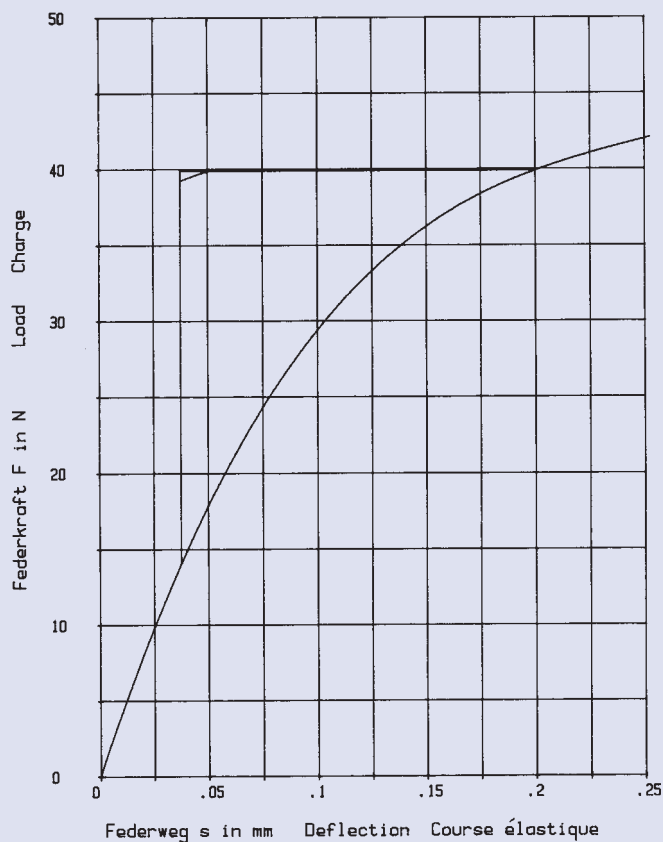

$$\begin{aligned}
 h_0 &= 0,25 \text{ mm} & D_e/D_1 &= 1,904 \\
 t &= 0,2 \text{ mm} & D_e/t &= 40 \\
 h_0/t &= 1,25 & m &= 0,057 \text{ g}
 \end{aligned}$$

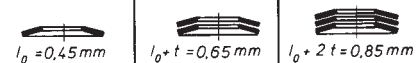

8 x 4,2 x 0,3

GR 1, DIN 2093 – B 8

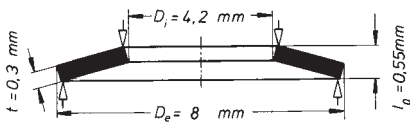

$h_0 = 0,25 \text{ mm}$        $D_e / D_i = 1,904$   
 $t = 0,3 \text{ mm}$        $D_e / t = 26,666$   
 $h_0 / t = 0,833$        $m = 0,085 \text{ g}$

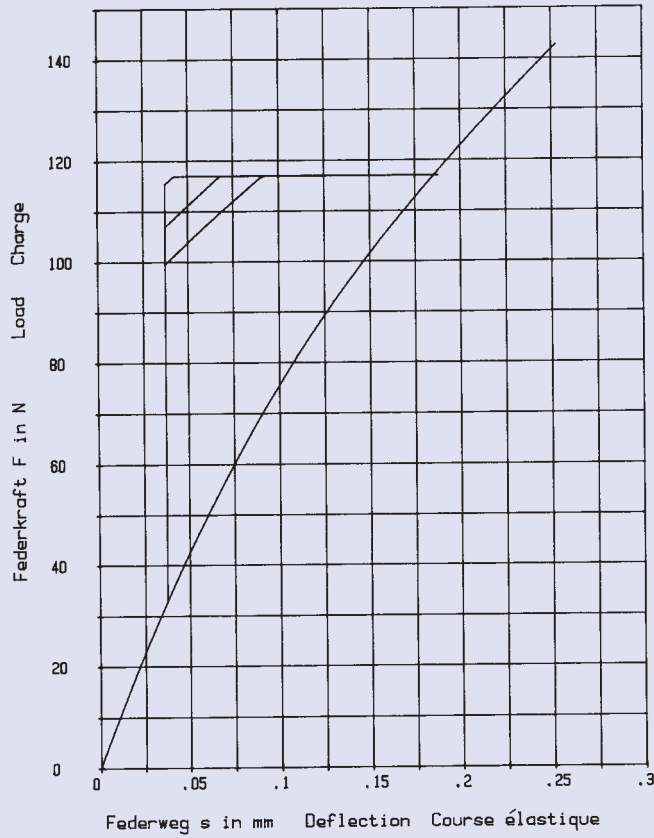
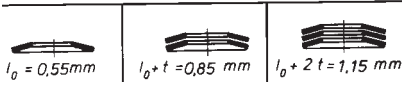

8 x 4,2 x 0,4

GR 1, DIN 2093 – A 8

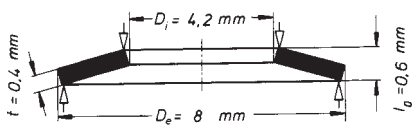

$h_0 = 0,2 \text{ mm}$        $D_e / D_i = 1,904$   
 $t = 0,4 \text{ mm}$        $D_e / t = 20$   
 $h_0 / t = 0,5$        $m = 0,114 \text{ g}$

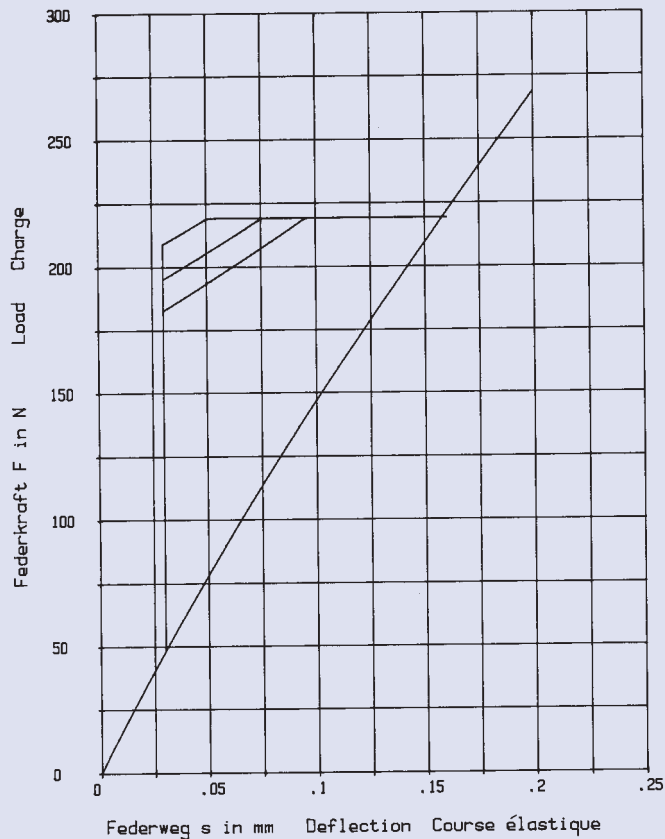
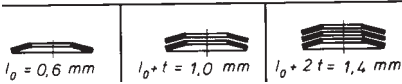

10 x 3,2 x 0,3

GR 1

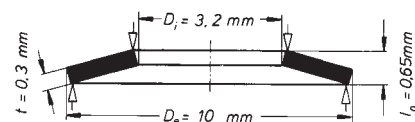
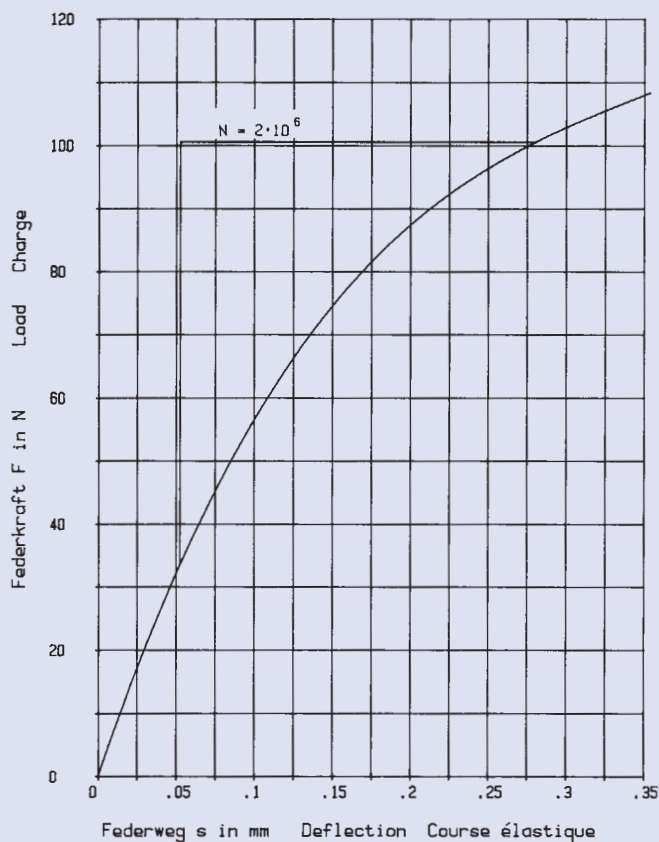

$h_0 = 0,35 \text{ mm}$        $D_e / D_i = 3,125$   
 $t = 0,3 \text{ mm}$        $D_e / t = 33,333$   
 $h_0 / t = 1,166$        $m = 0,166 \text{ g}$

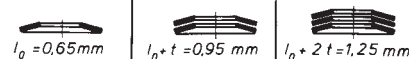

10 x 3,2 x 0,4

GR 1

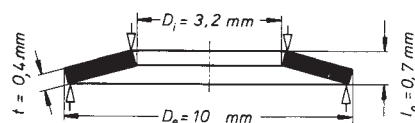
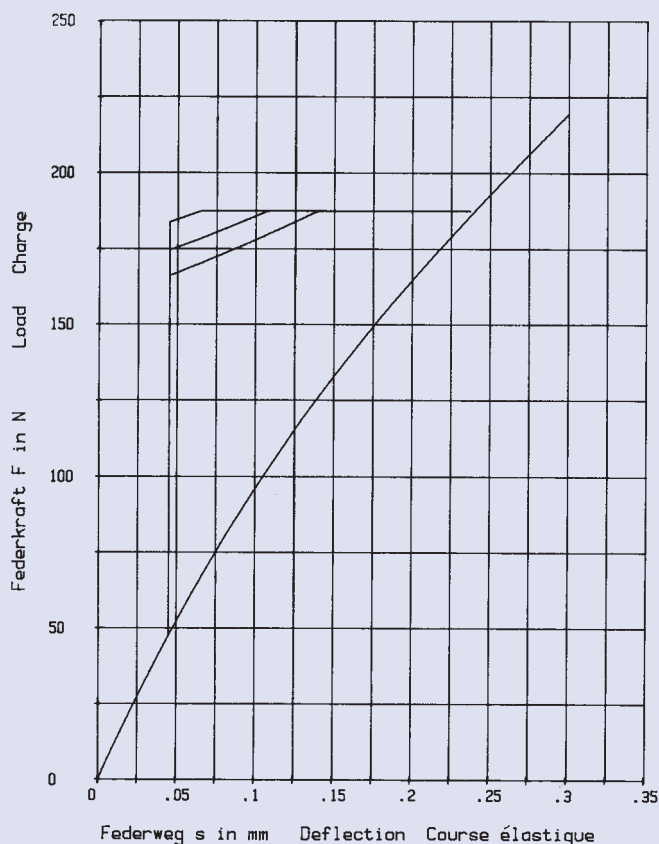

$h_0 = 0,3 \text{ mm}$        $D_e / D_i = 3,125$   
 $t = 0,4 \text{ mm}$        $D_e / t = 25$   
 $h_0 / t = 0,75$        $m = 0,221 \text{ g}$



10 x 3,2 x 0,5

GR 1

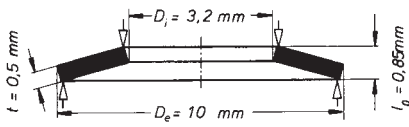

$h_0 = 0,35 \text{ mm}$        $D_e/D_i = 3,125$   
 $t = 0,5 \text{ mm}$        $D_e/t = 20$   
 $h_0/t = 0,7$        $m = 0,277 \text{ g}$

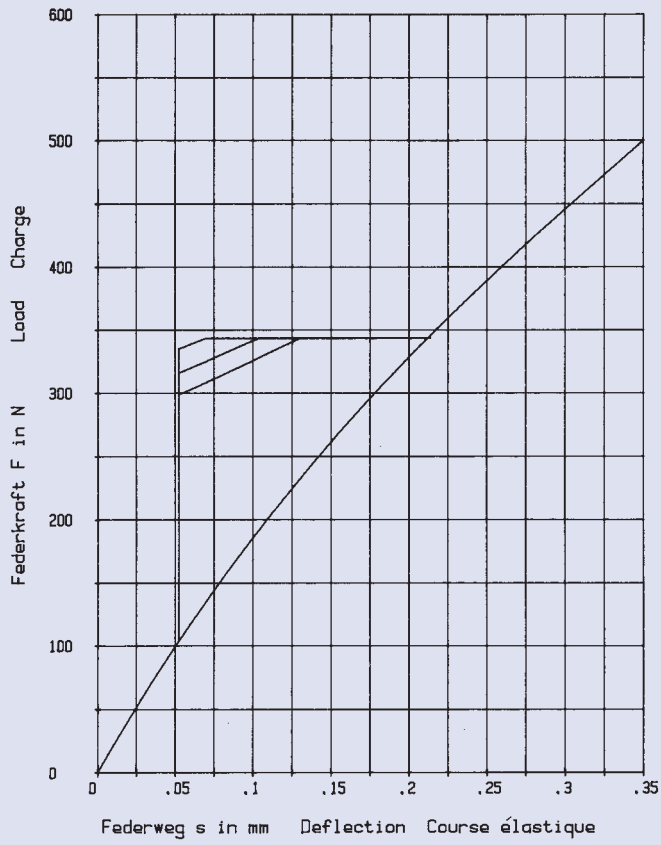
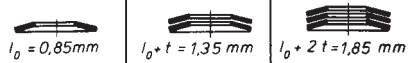

10 x 4,2 x 0,4

GR 1

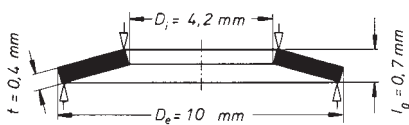

$h_0 = 0,3 \text{ mm}$        $D_e/D_i = 2,38$   
 $t = 0,4 \text{ mm}$        $D_e/t = 25$   
 $h_0/t = 0,75$        $m = 0,203 \text{ g}$

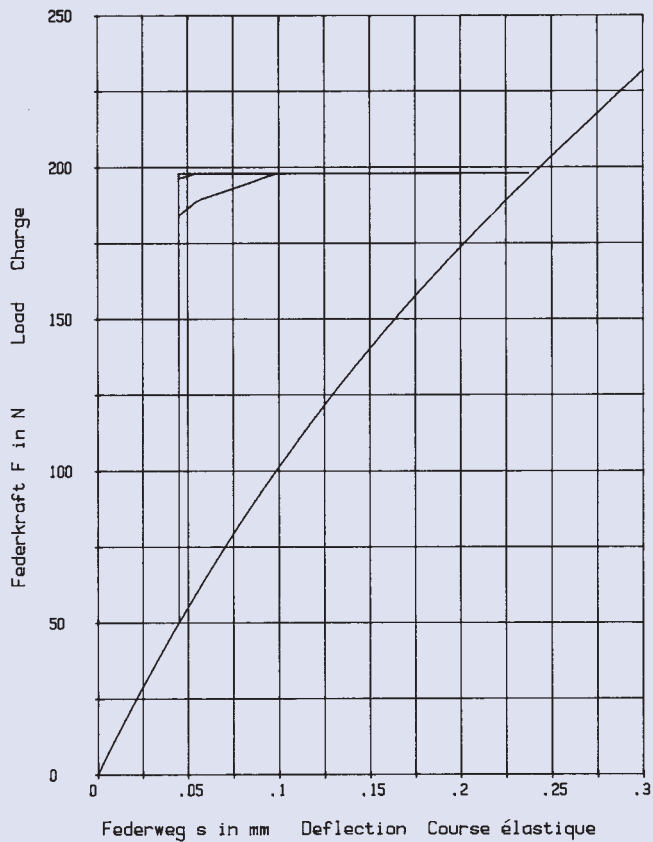
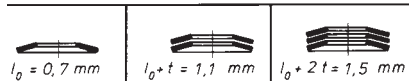



10 x 4,2 x 0,5

GR 1

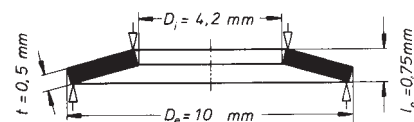
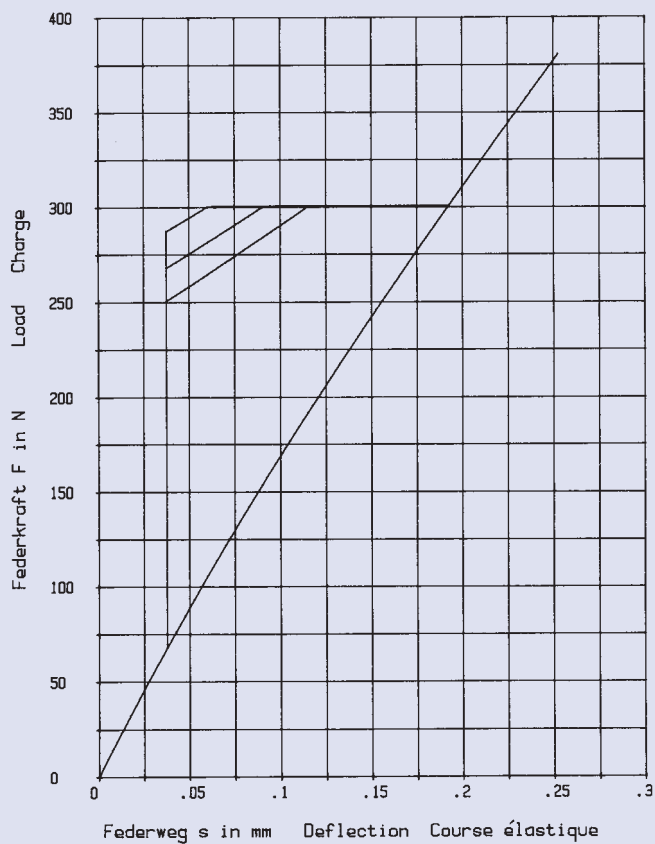

$$\begin{aligned}
 h_0 &= 0,25 \text{ mm} & D_e / D_i &= 2,38 \\
 t &= 0,5 \text{ mm} & D_e / t &= 20 \\
 h_0 / t &= 0,5 & m &= 0,254 \text{ g}
 \end{aligned}$$

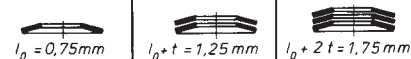

10 x 4,2 x 0,6

GR 1

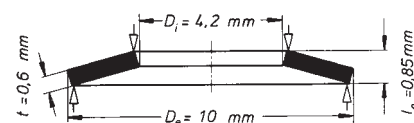
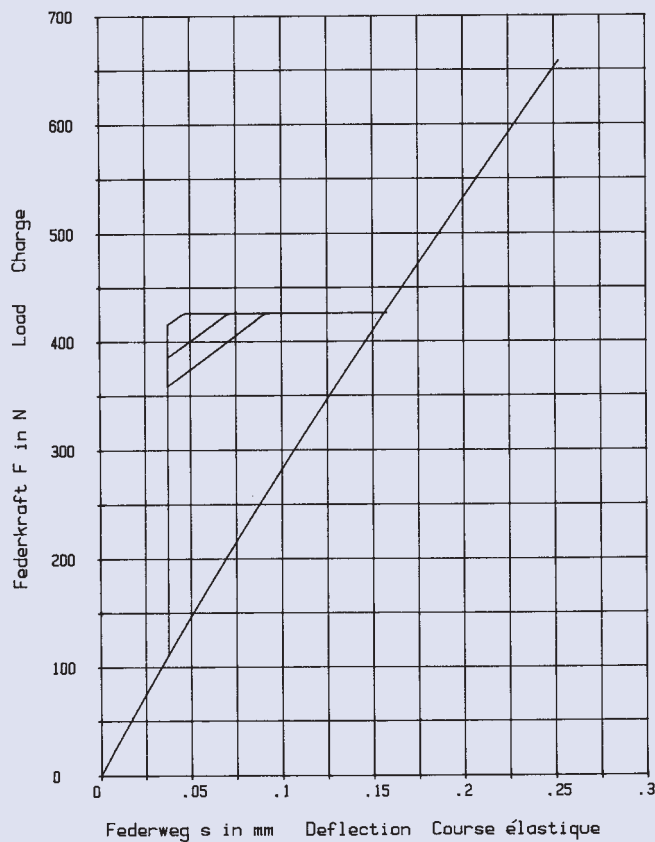

$$\begin{aligned}
 h_0 &= 0,25 \text{ mm} & D_e / D_i &= 2,38 \\
 t &= 0,6 \text{ mm} & D_e / t &= 16,666 \\
 h_0 / t &= 0,416 & m &= 0,304 \text{ g}
 \end{aligned}$$



10 x 5,2 x 0,25

GR 1, DIN 2093 – C 10

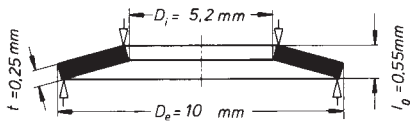

$h_0 = 0,3 \text{ mm}$        $D_e/D_i = 1,923$   
 $t = 0,25 \text{ mm}$        $D_e/t = 40$   
 $h_0/t = 1,2$            $m = 0,112 \text{ g}$

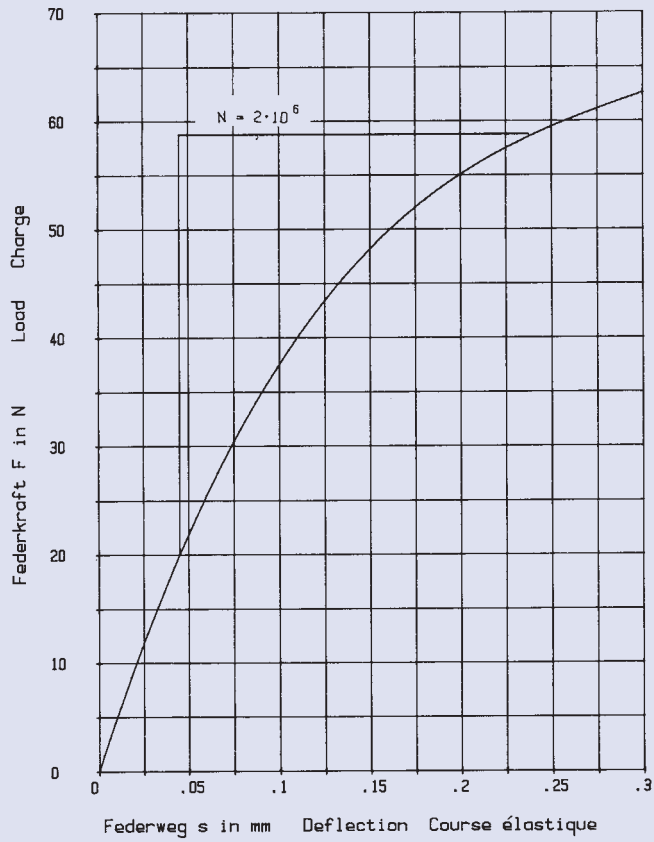
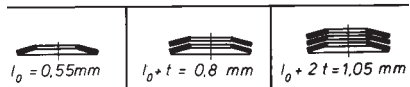

10 x 5,2 x 0,4

GR 1, DIN 2093 – B 10

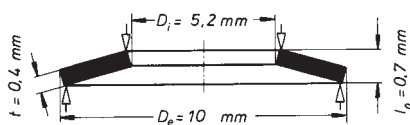

$h_0 = 0,3 \text{ mm}$        $D_e/D_i = 1,923$   
 $t = 0,4 \text{ mm}$        $D_e/t = 25$   
 $h_0/t = 0,75$        $m = 0,18 \text{ g}$

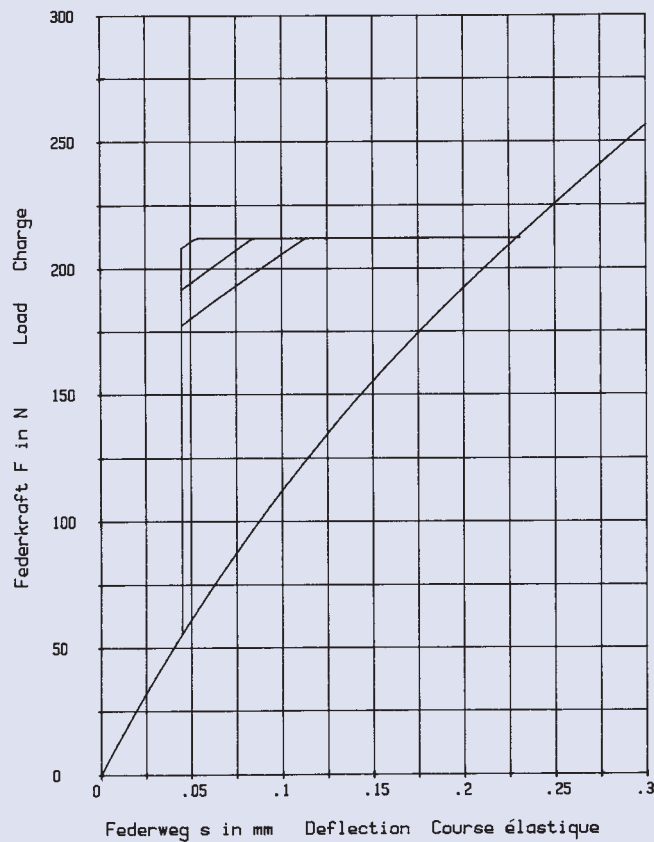
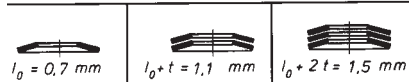

10 x 5,2 x 0,5

GR 1, DIN 2093 – A 10

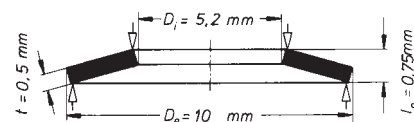
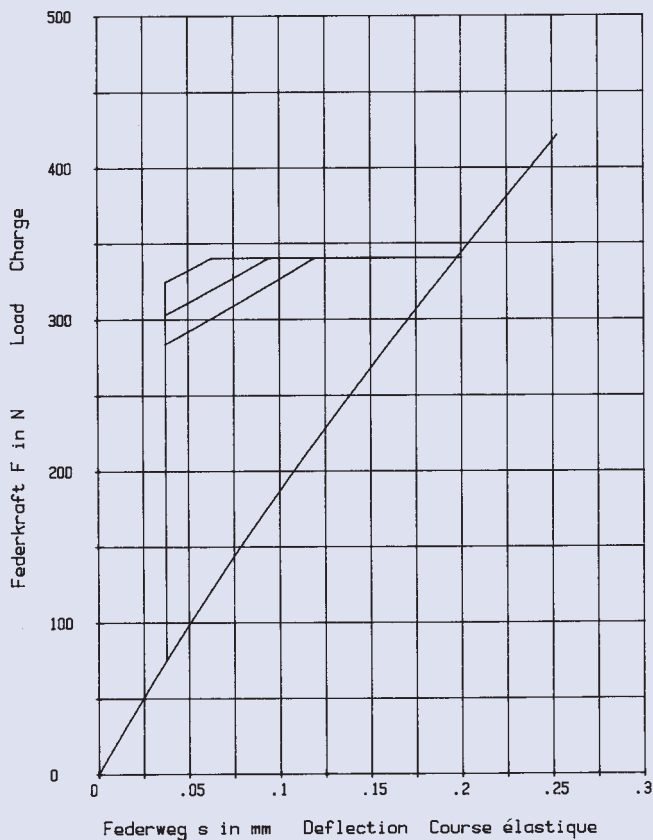

$$\begin{aligned}
 h_0 &= 0,25 \text{ mm} & D_e/D_i &= 1,923 \\
 t &= 0,5 \text{ mm} & D_e/t &= 20 \\
 h_0/t &= 0,5 & m &= 0,225 \text{ g}
 \end{aligned}$$

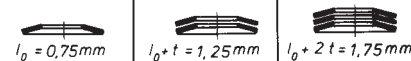

12 x 4,2 x 0,4

GR 1

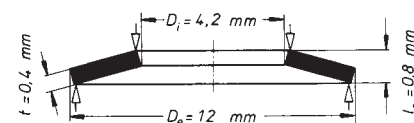
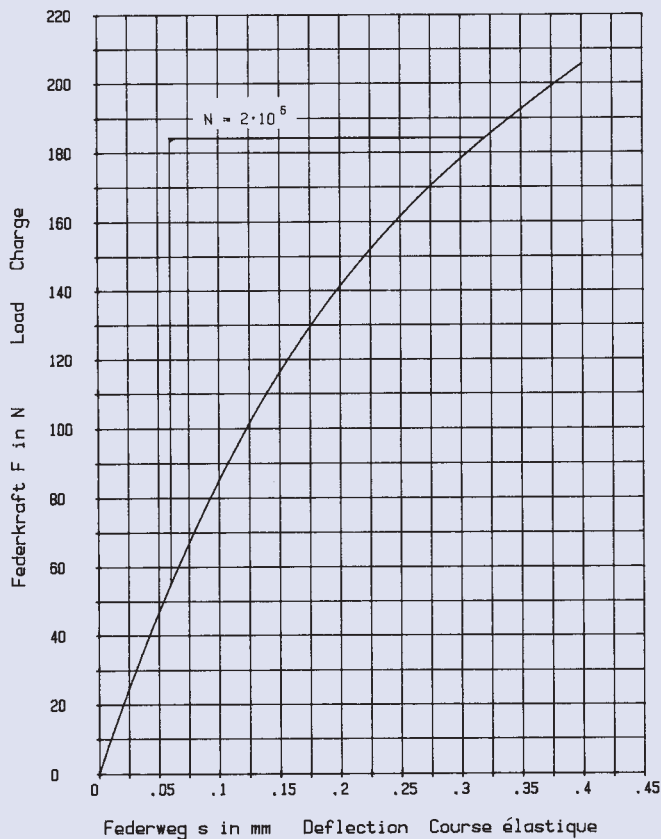

$$\begin{aligned}
 h_0 &= 0,4 \text{ mm} & D_e/D_i &= 2,857 \\
 t &= 0,4 \text{ mm} & D_e/t &= 30 \\
 h_0/t &= 1 & m &= 0,311 \text{ g}
 \end{aligned}$$

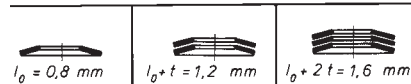

12 x 4,2 x 0,5

GR 1

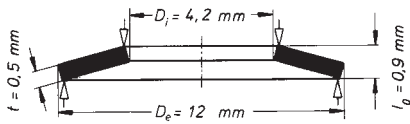

$h_0 = 0,4 \text{ mm}$        $D_e / D_i = 2,857$   
 $t = 0,5 \text{ mm}$        $D_e / t = 24$   
 $h_0 / t = 0,8$        $m = 0,389 \text{ g}$

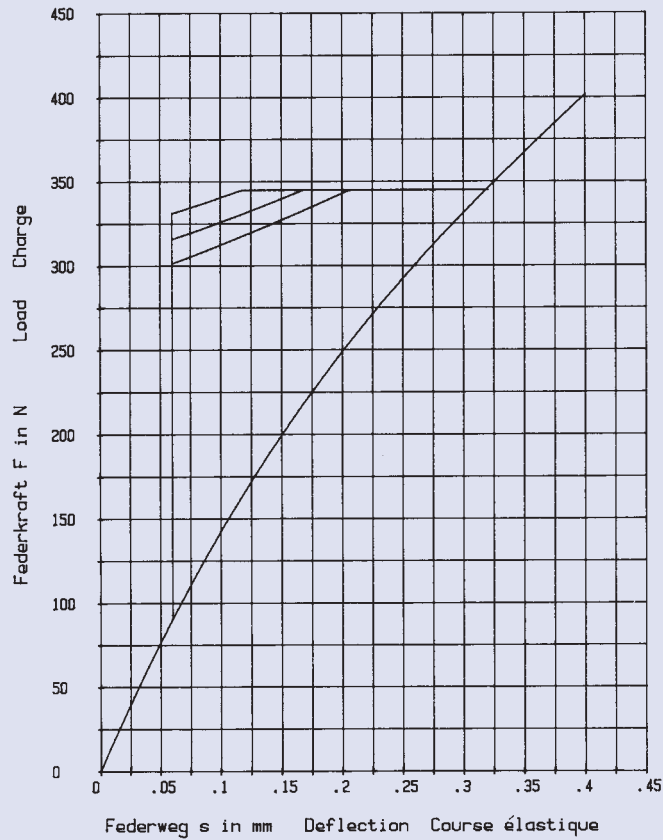
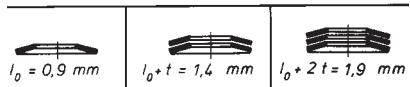

12 x 4,2 x 0,6

GR 1

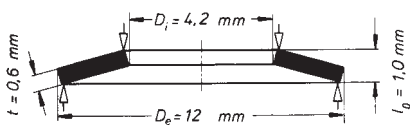

$h_0 = 0,4 \text{ mm}$        $D_e / D_i = 2,857$   
 $t = 0,6 \text{ mm}$        $D_e / t = 20$   
 $h_0 / t = 0,666$        $m = 0,467 \text{ g}$

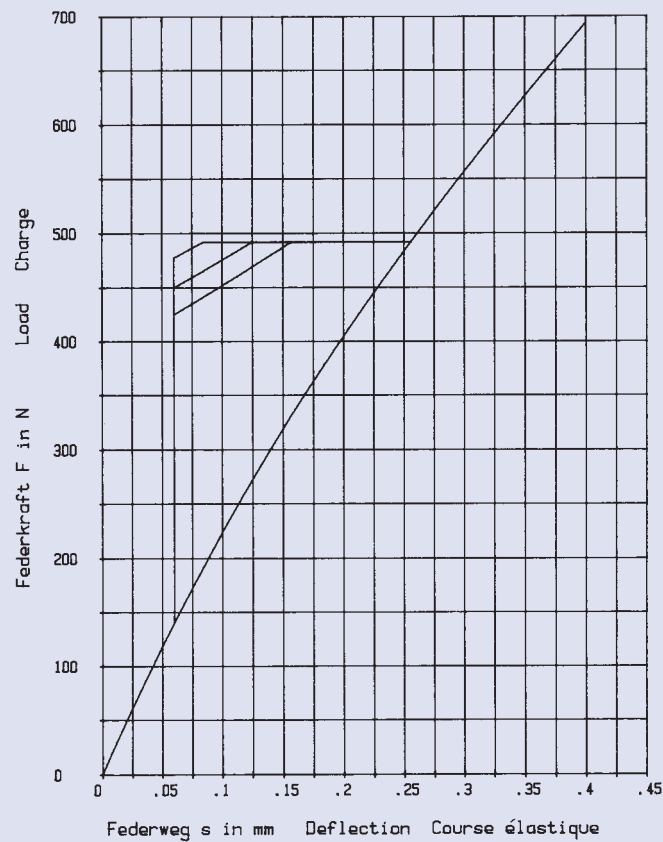
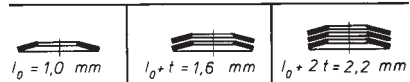

12 x 5,2 x 0,5

GR 1

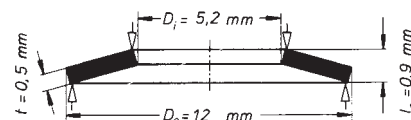
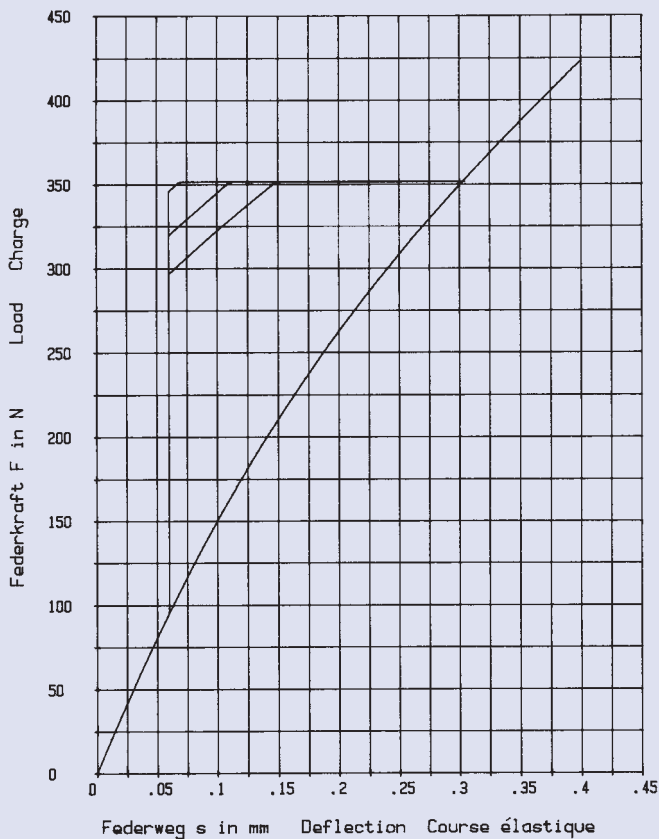

$$\begin{aligned}
 h_0 &= 0,4 \text{ mm} & D_e/D_i &= 2,307 \\
 t &= 0,5 \text{ mm} & D_e/t &= 24 \\
 h_0/t &= 0,8 & m &= 0,360 \text{ g}
 \end{aligned}$$



12 x 5,2 x 0,6

GR 1

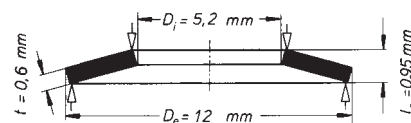
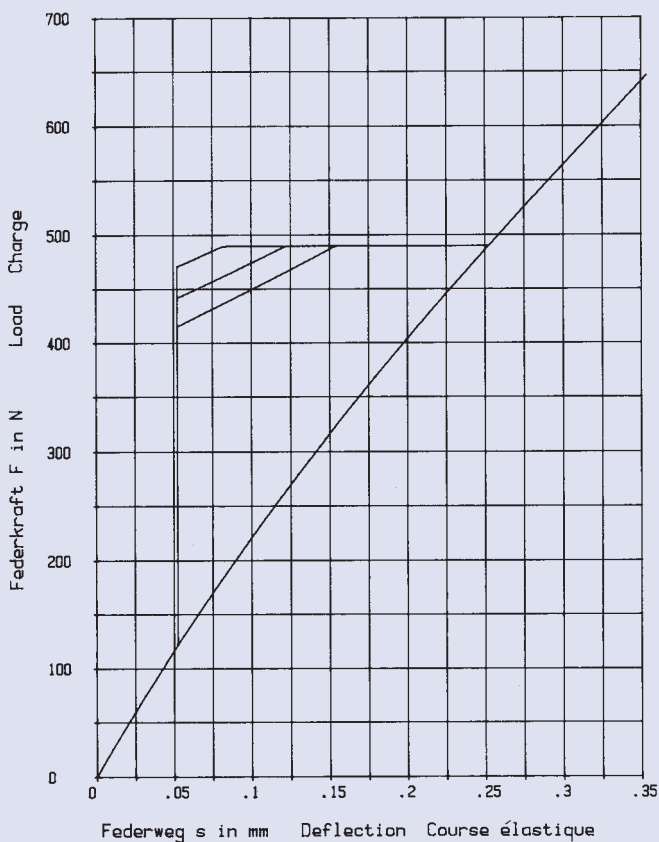

$$\begin{aligned}
 h_0 &= 0,35 \text{ mm} & D_e/D_i &= 2,307 \\
 t &= 0,6 \text{ mm} & D_e/t &= 20 \\
 h_0/t &= 0,583 & m &= 0,432 \text{ g}
 \end{aligned}$$

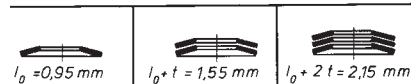

12 x 6,2 x 0,5

GR 1

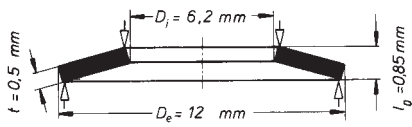

$h_0 = 0,35 \text{ mm}$        $D_e / D_i = 1,935$   
 $t = 0,5 \text{ mm}$        $D_e / t = 24$   
 $h_0 / t = 0,7$        $m = 0,325 \text{ g}$

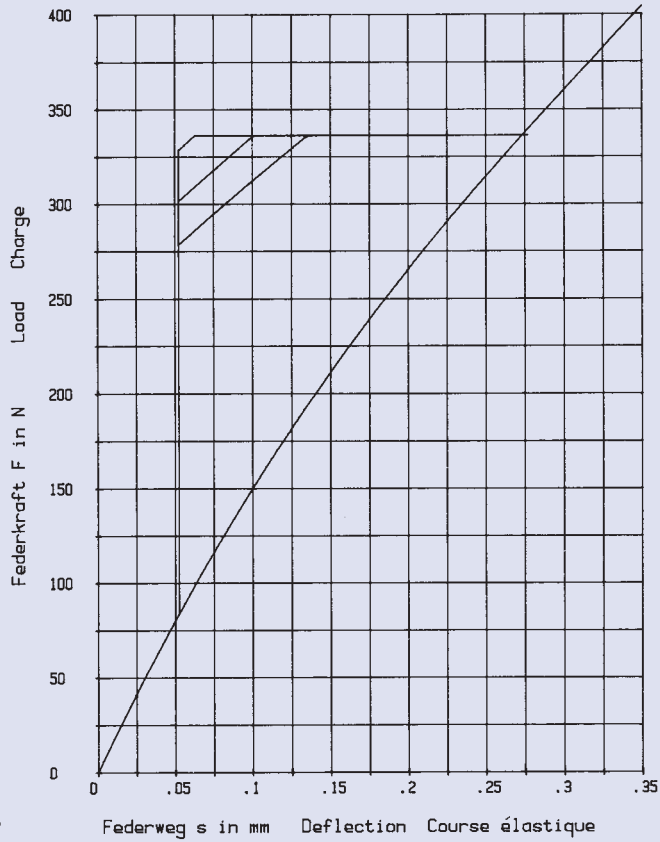
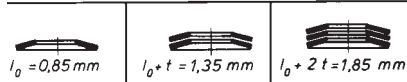

12 x 6,2 x 0,6

GR 1

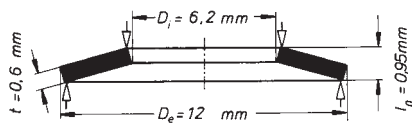

$h_0 = 0,35 \text{ mm}$        $D_e / D_i = 1,935$   
 $t = 0,6 \text{ mm}$        $D_e / t = 20$   
 $h_0 / t = 0,583$        $m = 0,390 \text{ g}$

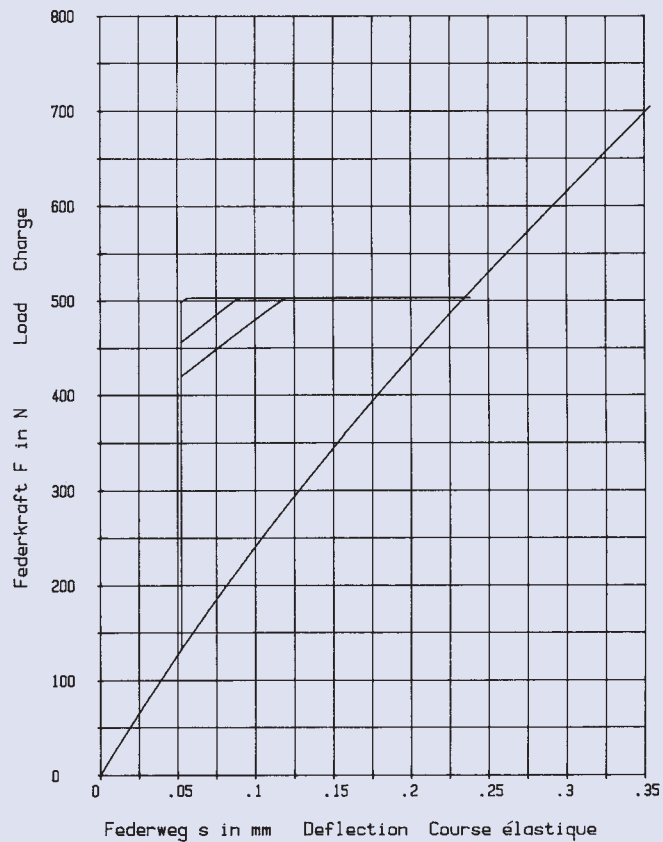
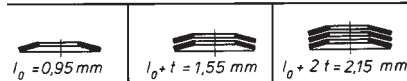

12,5 x 6,2 x 0,35

GR 1, DIN 2093 – C 12,5

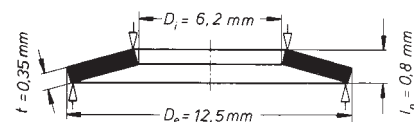
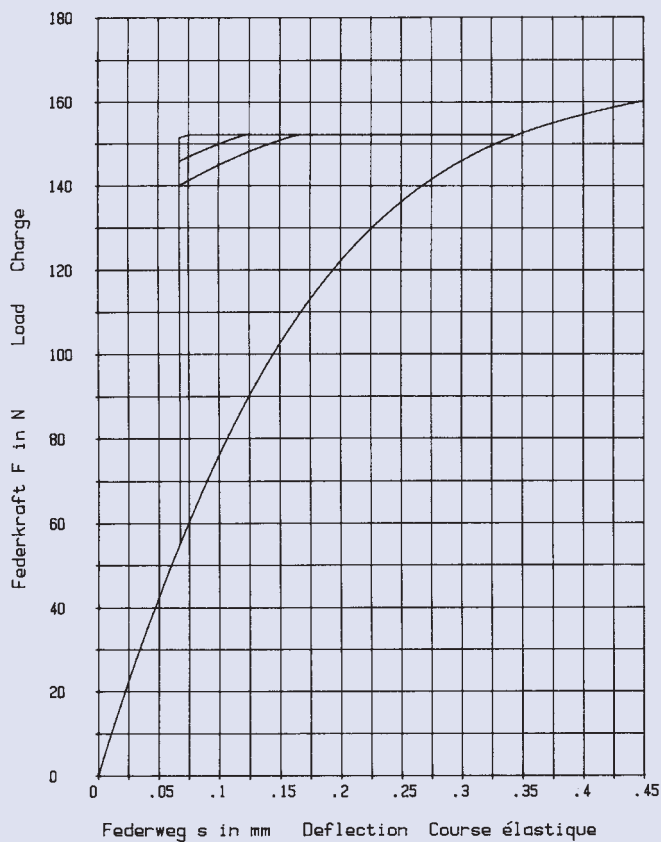

$$\begin{aligned}
 h_0 &= 0,45 \text{ mm} & D_e / D_i &= 2,016 \\
 t &= 0,35 \text{ mm} & D_e / t &= 35,714 \\
 h_0 / t &= 1,285 & m &= 0,254 \text{ g}
 \end{aligned}$$

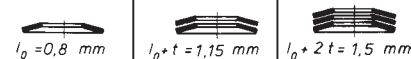

12,5 x 6,2 x 0,5

GR 1, DIN 2093 – B 12,5

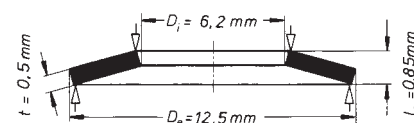
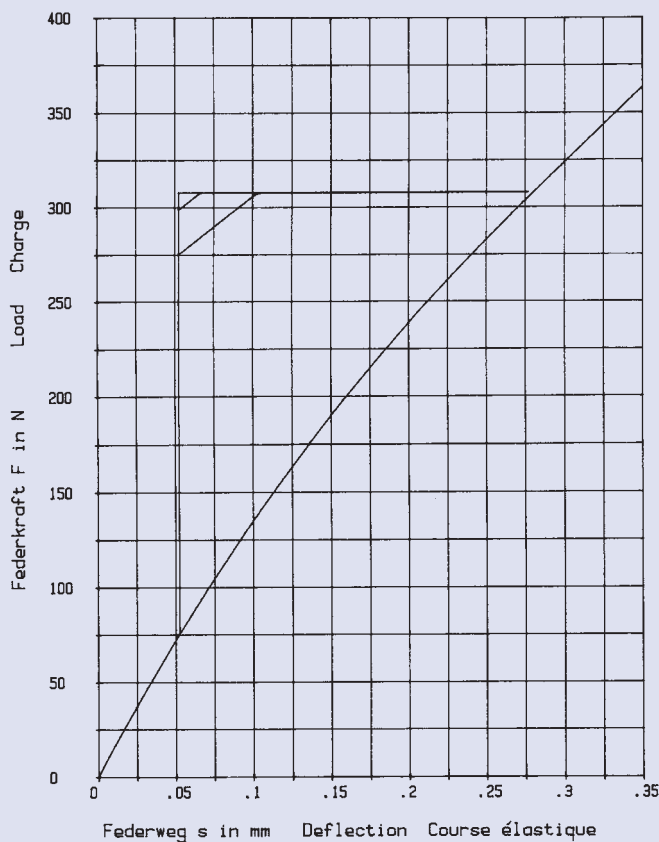

$$\begin{aligned}
 h_0 &= 0,35 \text{ mm} & D_e / D_i &= 2,016 \\
 t &= 0,5 \text{ mm} & D_e / t &= 25 \\
 h_0 / t &= 0,7 & m &= 0,363 \text{ g}
 \end{aligned}$$

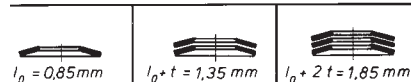

12,5 x 6,2 x 0,7

GR 1, DIN 2093 – A 12,5

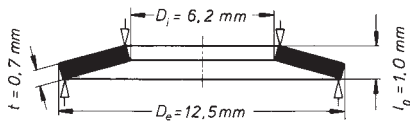

$h_0 = 0,3 \text{ mm}$        $D_e / D_i = 2,016$   
 $t = 0,7 \text{ mm}$        $D_e / t = 17,857$   
 $h_0 / t = 0,428$        $m = 0,508 \text{ g}$

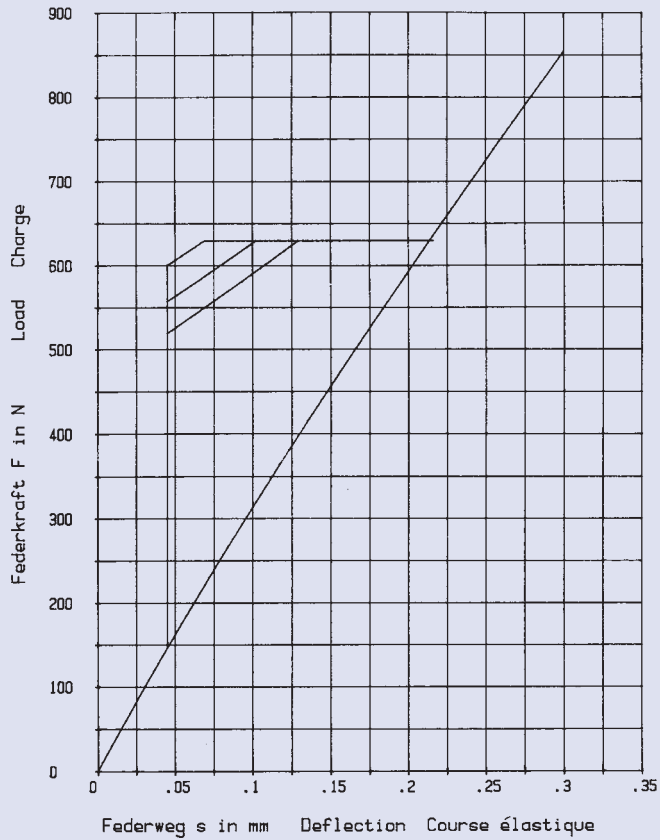
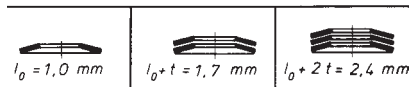

14 x 7,2 x 0,35

GR 1, DIN 2093 – C 14

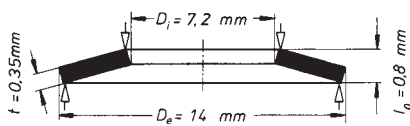

$h_0 = 0,45 \text{ mm}$        $D_e / D_i = 1,944$   
 $t = 0,35 \text{ mm}$        $D_e / t = 40$   
 $h_0 / t = 1,285$        $m = 0,311 \text{ g}$

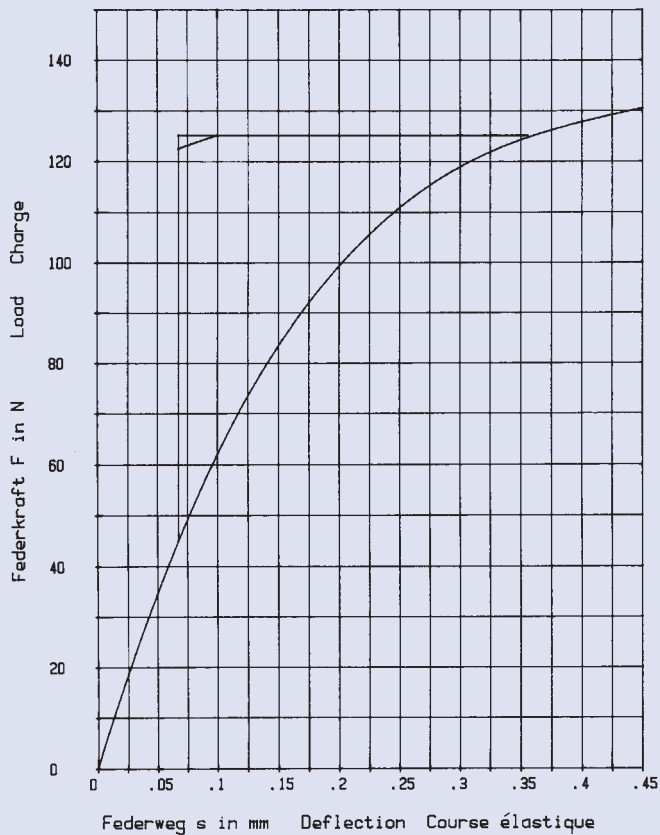
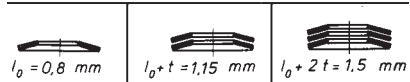



14 x 7,2 x 0,5

GR 1, DIN 2093 – B 14

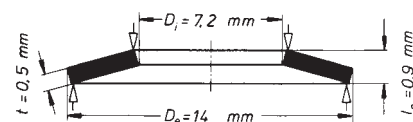

$$h_0 = 0,4 \text{ mm} \quad D_e/D_i = 1,944$$

$$t = 0,5 \text{ mm} \quad D_e/t = 28$$

$$h_0/t = 0,8 \quad m = 0,444 \text{ g}$$

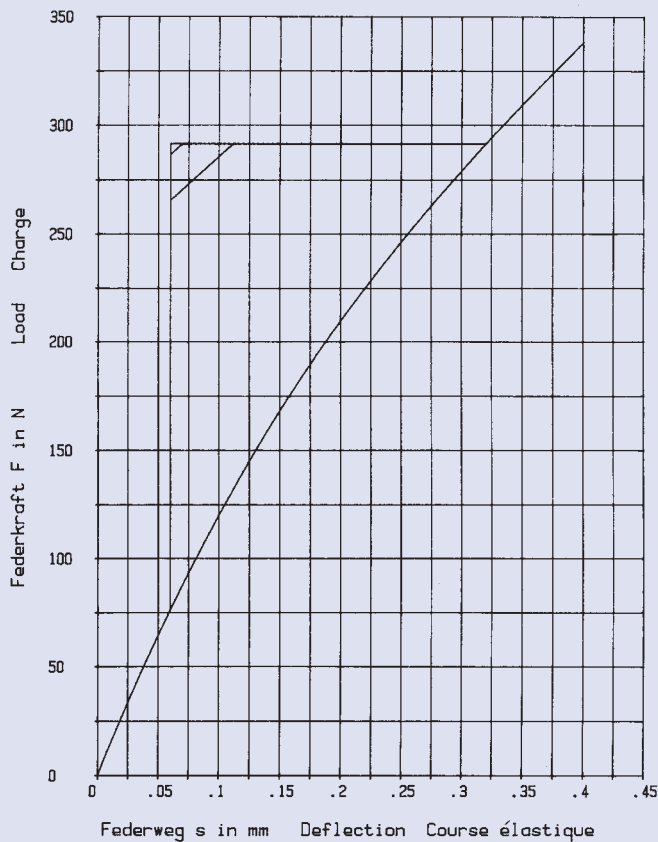
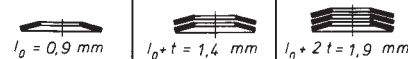

14 x 7,2 x 0,8

GR 1, DIN 2093 – A 14

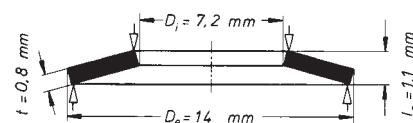

$$h_0 = 0,3 \text{ mm} \quad D_e/D_i = 1,944$$

$$t = 0,8 \text{ mm} \quad D_e/t = 17,5$$

$$h_0/t = 0,375 \quad m = 0,711 \text{ g}$$

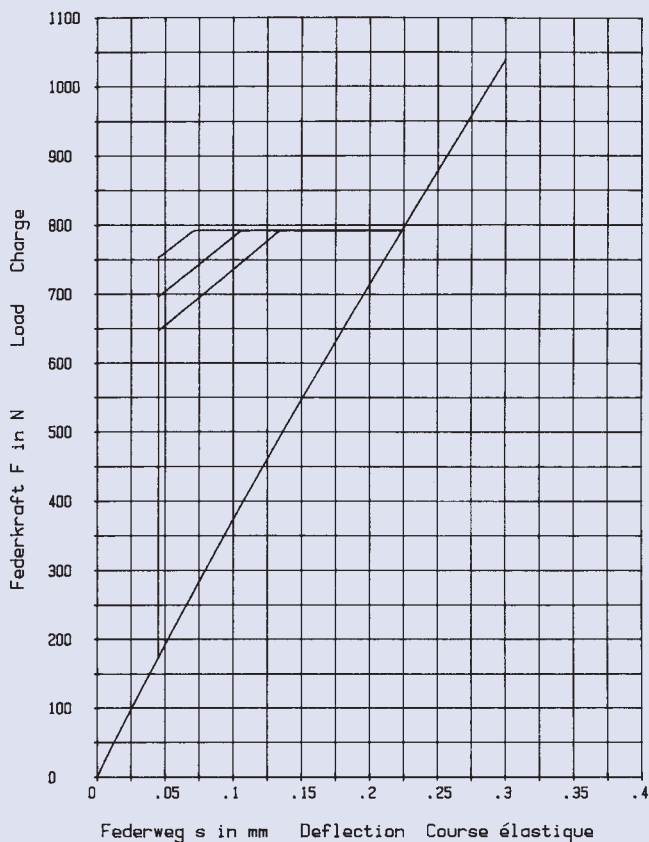
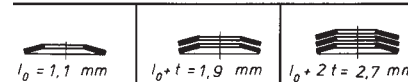

15 x 5,2 x 0,4

GR 1

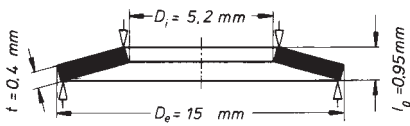

$h_0 = 0,55 \text{ mm}$        $D_e / D_i = 2,884$   
 $t = 0,4 \text{ mm}$        $D_e / t = 37,5$   
 $h_0 / t = 1,375$        $m = 0,488 \text{ g}$

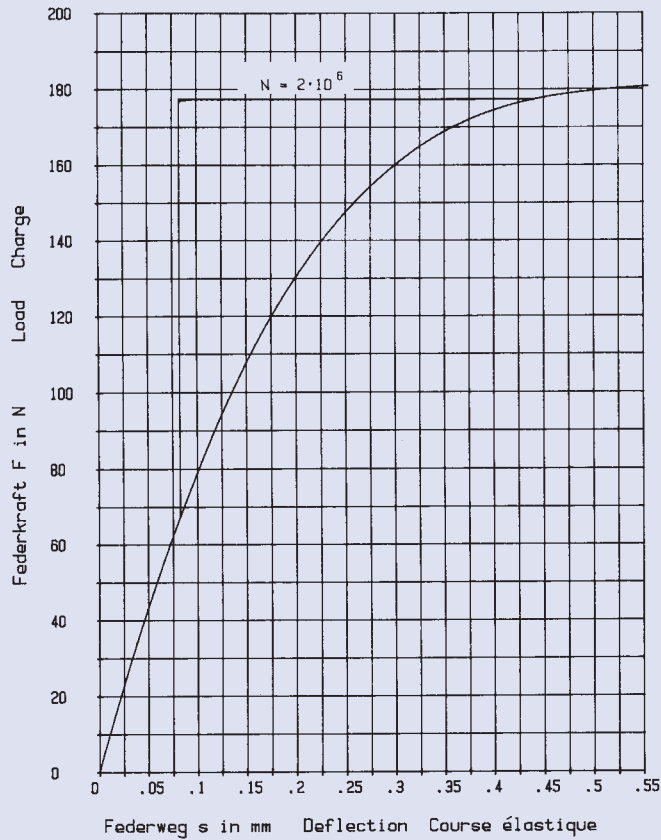
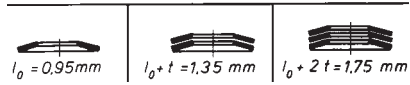

15 x 5,2 x 0,5

GR 1

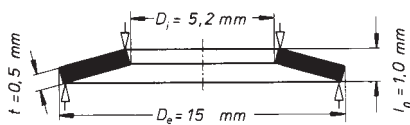

$h_0 = 0,5 \text{ mm}$        $D_e / D_i = 2,884$   
 $t = 0,5 \text{ mm}$        $D_e / t = 30$   
 $h_0 / t = 1,0$        $m = 0,610 \text{ g}$

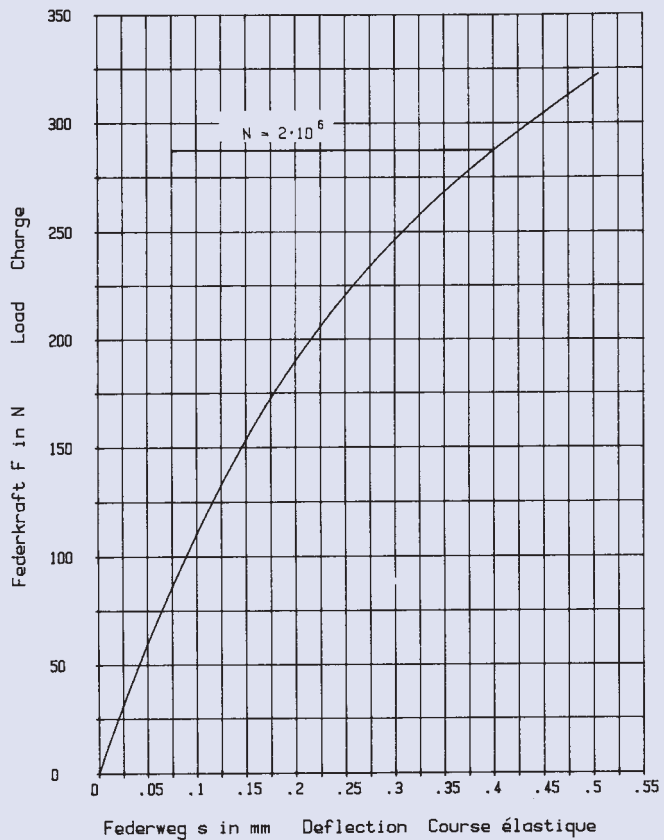
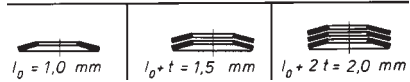

15 x 5,2 x 0,6

GR 1

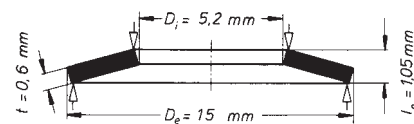
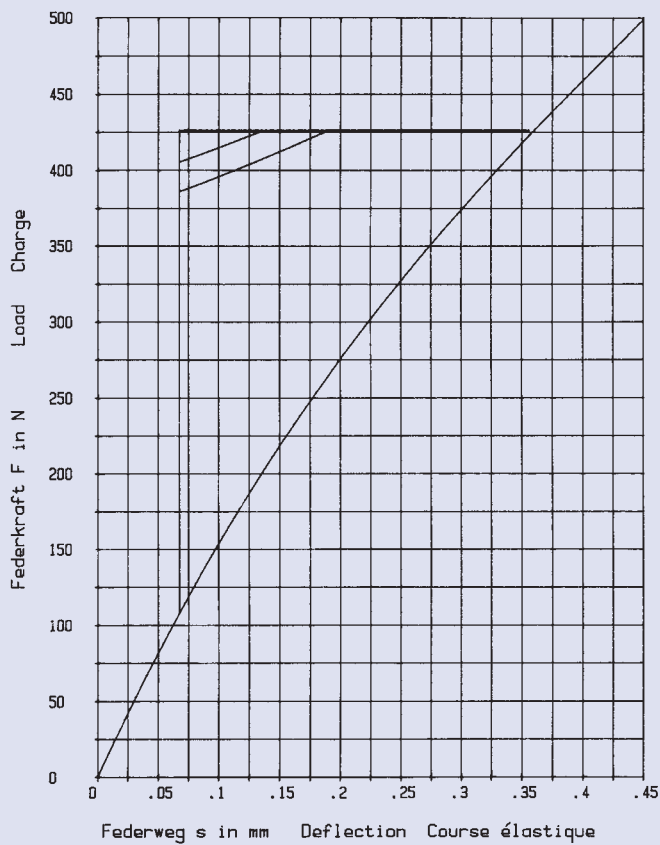

$h_0 = 0,45 \text{ mm}$        $D_e / D_i = 2,884$   
 $t = 0,6 \text{ mm}$        $D_e / t = 25$   
 $h_0 / t = 0,75$        $m = 0,732 \text{ g}$

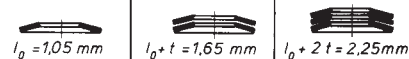

15 x 5,2 x 0,7

GR 1

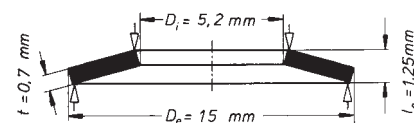
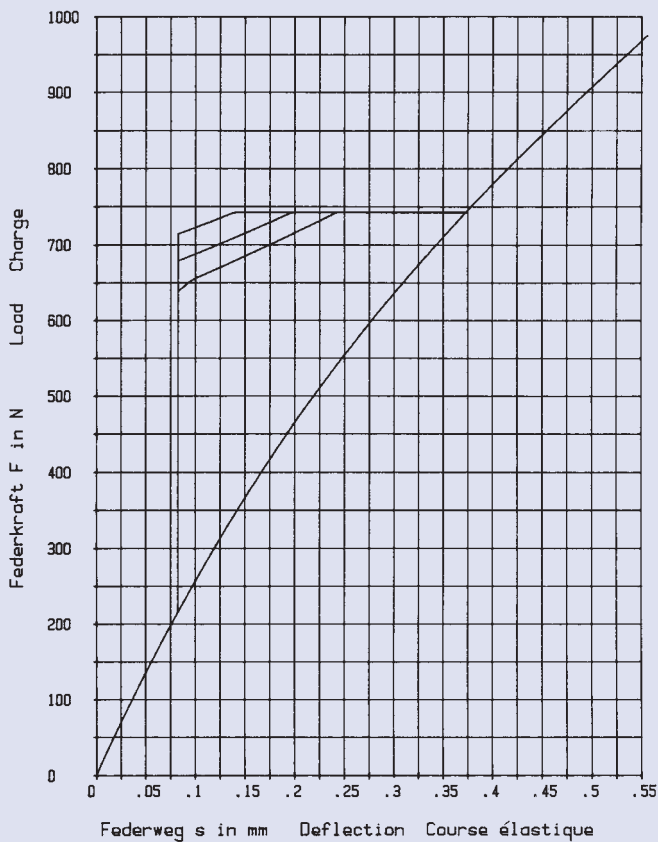

$h_0 = 0,55 \text{ mm}$        $D_e / D_i = 2,884$   
 $t = 0,7 \text{ mm}$        $D_e / t = 21,428$   
 $h_0 / t = 0,785$        $m = 0,854 \text{ g}$

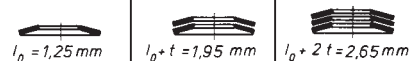

15 x 6,2 x 0,5

GR 1

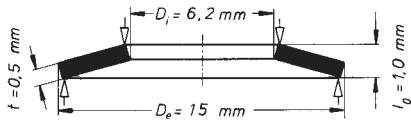

$h_0 = 0,5 \text{ mm}$        $D_e/D_i = 2,419$   
 $t = 0,5 \text{ mm}$        $D_e/t = 30$   
 $h_0/t = 1,0$        $m = 0,575 \text{ g}$

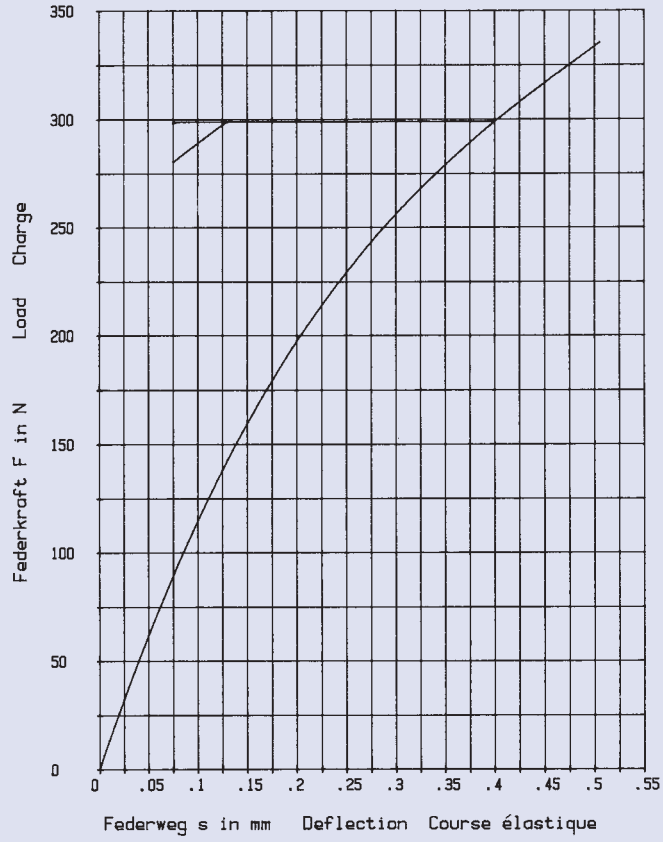
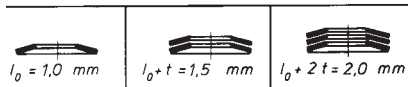

15 x 6,2 x 0,6

GR 1

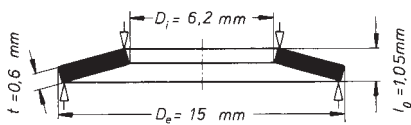

$h_0 = 0,45 \text{ mm}$        $D_e/D_i = 2,419$   
 $t = 0,6 \text{ mm}$        $D_e/t = 25$   
 $h_0/t = 0,75$        $m = 0,690 \text{ g}$

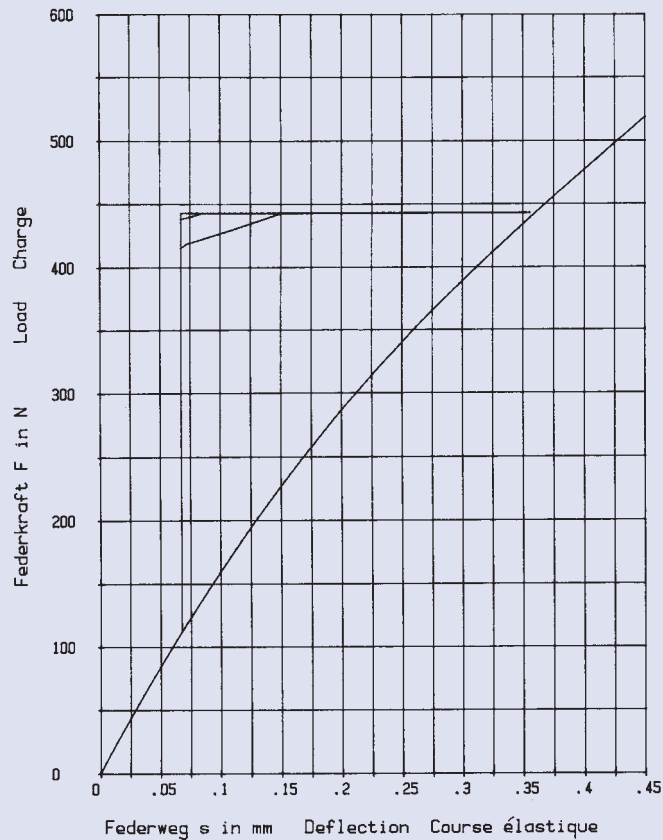
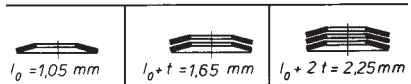

15 x 6,2 x 0,7

GR 1

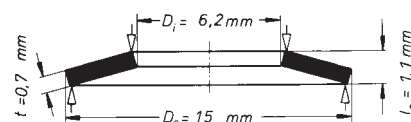
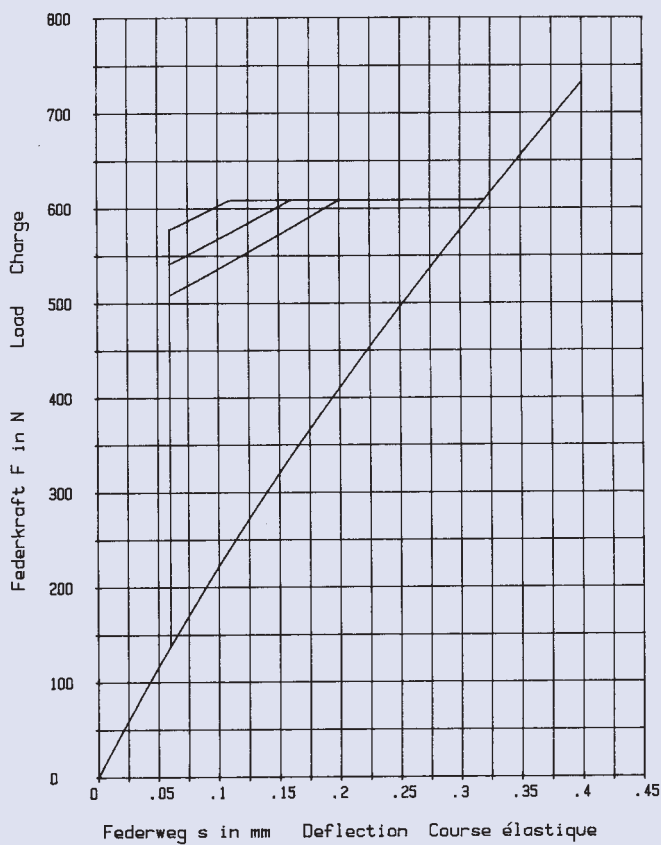

$h_0 = 0,4 \text{ mm}$        $D_e / D_i = 2,419$   
 $t = 0,7 \text{ mm}$        $D_e / t = 21,428$   
 $h_0 / t = 0,571$        $m = 0,805 \text{ g}$

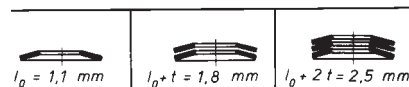

15 x 8,2 x 0,7

GR 1

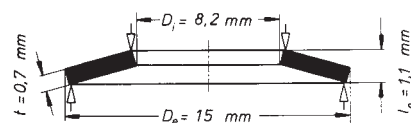
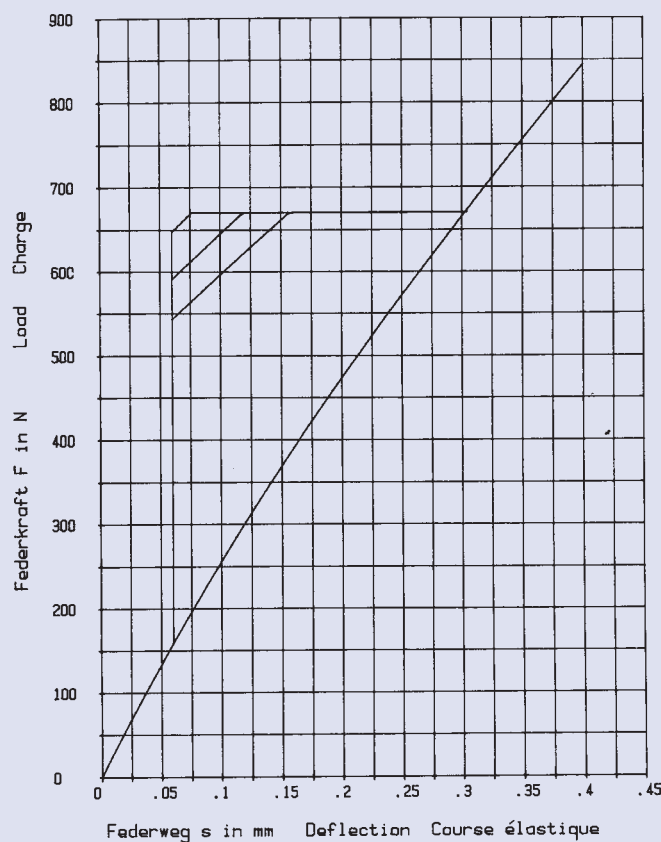

$h_0 = 0,4 \text{ mm}$        $D_e / D_i = 1,829$   
 $t = 0,7 \text{ mm}$        $D_e / t = 21,428$   
 $h_0 / t = 0,571$        $m = 0,681 \text{ g}$

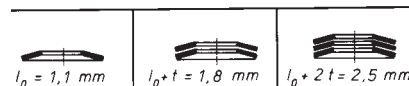

15 x 8,2 x 0,8

GR 1

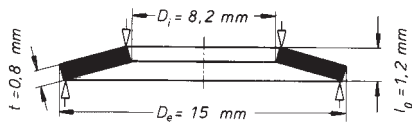

$h_0 = 0,4 \text{ mm}$        $D_e/D_i = 1,829$   
 $t = 0,8 \text{ mm}$        $D_e/t = 18,75$   
 $h_0/t = 0,5$        $m = 0,778 \text{ g}$

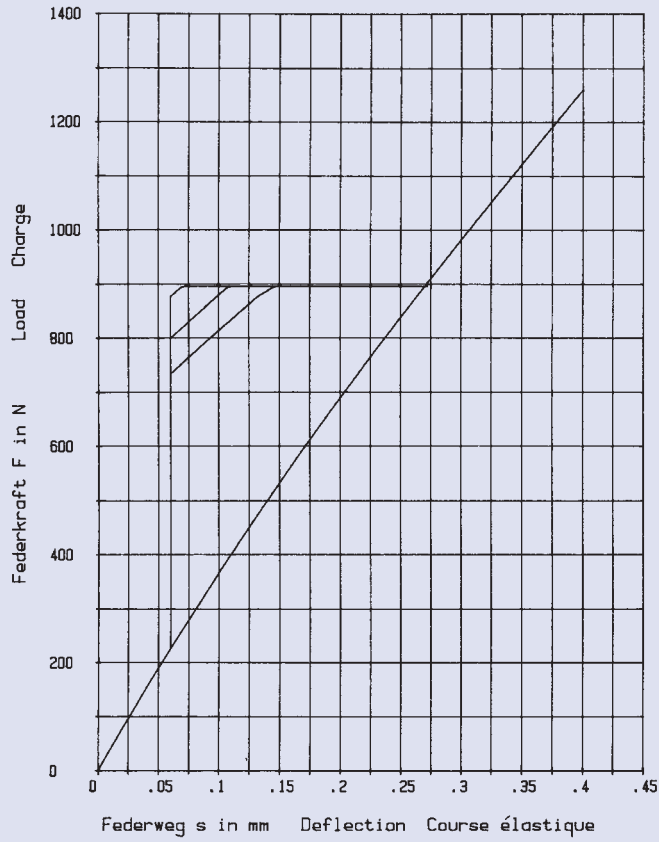
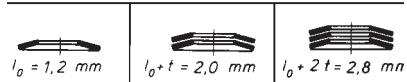

16 x 8,2 x 0,4

GR 1, DIN 2093 – C 16

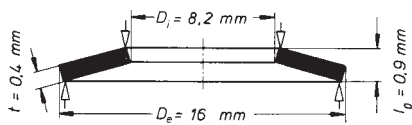

$h_0 = 0,5 \text{ mm}$        $D_e/D_i = 1,951$   
 $t = 0,4 \text{ mm}$        $D_e/t = 40$   
 $h_0/t = 1,25$        $m = 0,465 \text{ g}$

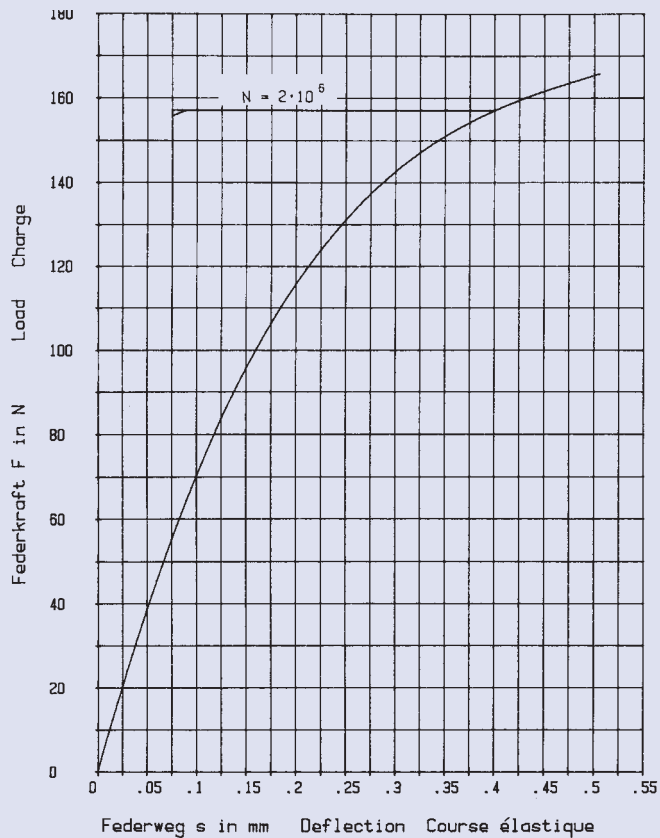
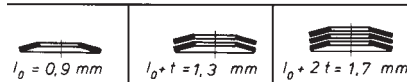

16 x 8,2 x 0,6

GR 1, DIN 2093 – B 16

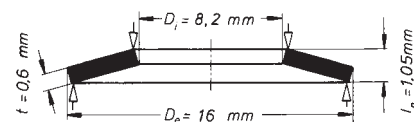
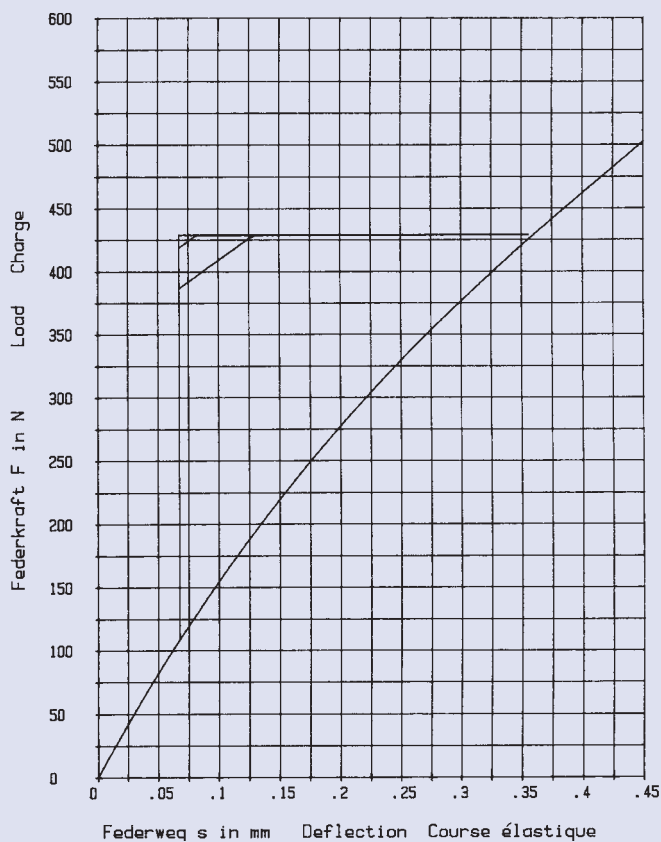

$h_0 = 0,45 \text{ mm}$        $D_e / D_i = 1,951$   
 $t = 0,6 \text{ mm}$        $D_e / t = 26,666$   
 $h_0 / t = 0,75$        $m = 0,698 \text{ g}$

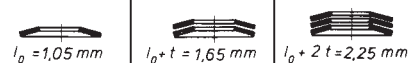

16 x 8,2 x 0,9

GR 1, DIN 2093 – A 16

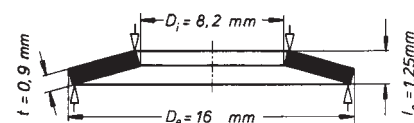
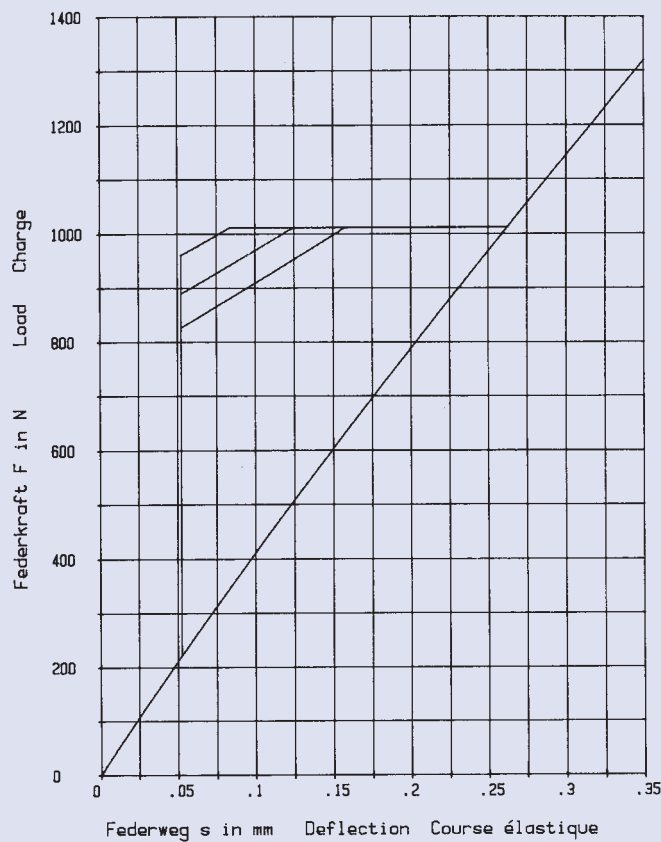

$h_0 = 0,35 \text{ mm}$        $D_e / D_i = 1,951$   
 $t = 0,9 \text{ mm}$        $D_e / t = 17,777$   
 $h_0 / t = 0,388$        $m = 1,047 \text{ g}$

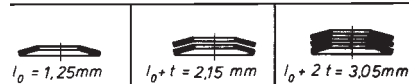

18 x 6,2 x 0,4

GR 1

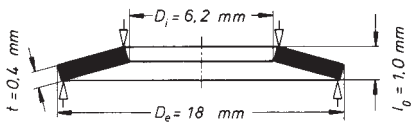

$h_0 = 0.6 \text{ mm}$        $D_e/D_i = 2.903$   
 $t = 0.4 \text{ mm}$        $D_e/t = 45$   
 $h_0/t = 1.5$        $m = 0.704 \text{ g}$

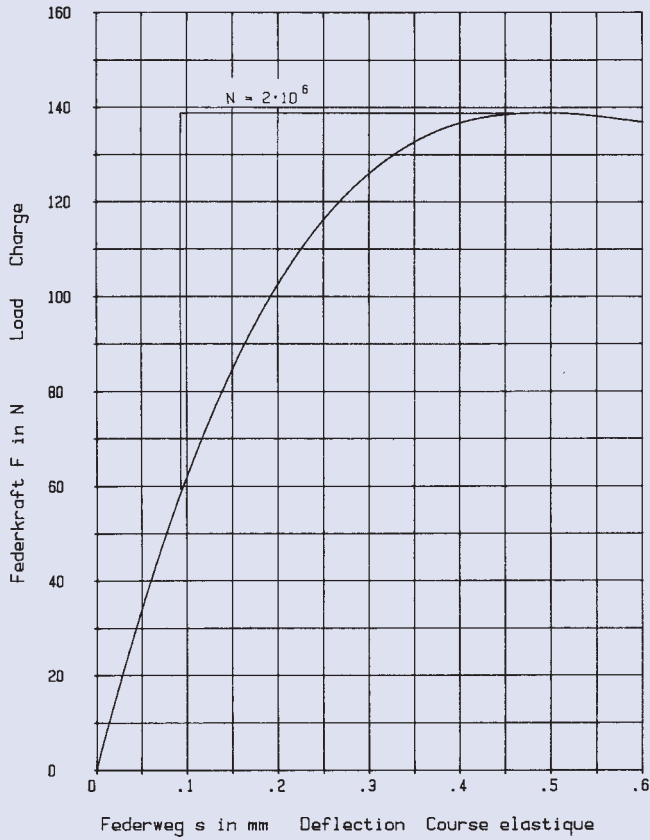
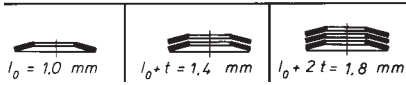

18 x 6,2 x 0,5

GR 1

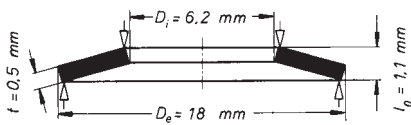

$h_0 = 0.6 \text{ mm}$        $D_e/D_i = 2.903$   
 $t = 0.5 \text{ mm}$        $D_e/t = 36$   
 $h_0/t = 1.2$        $m = 0.88 \text{ g}$

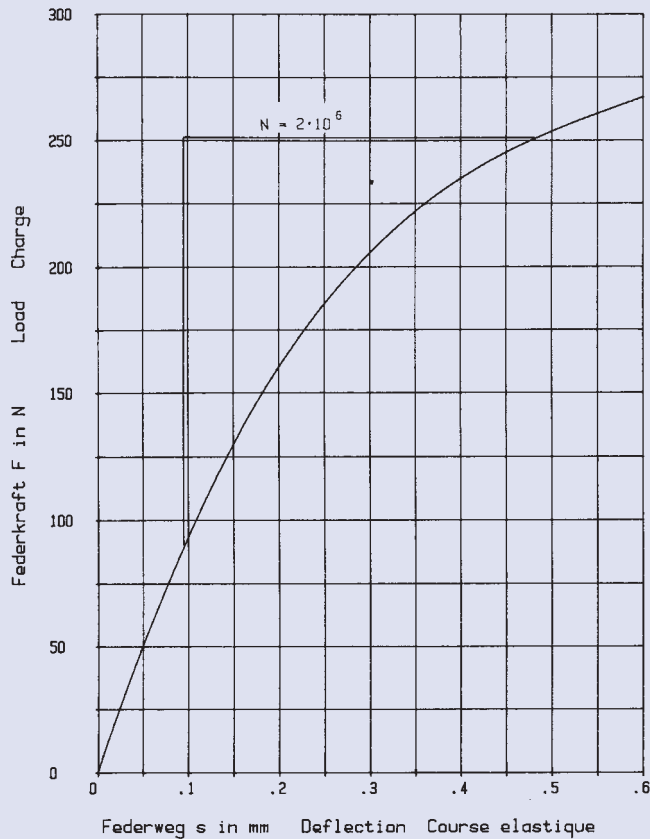
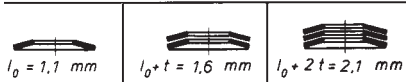



**18 x 6,2 x 0,6**

**GR 1**

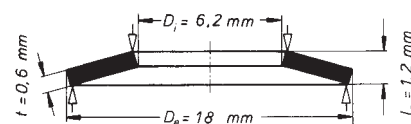
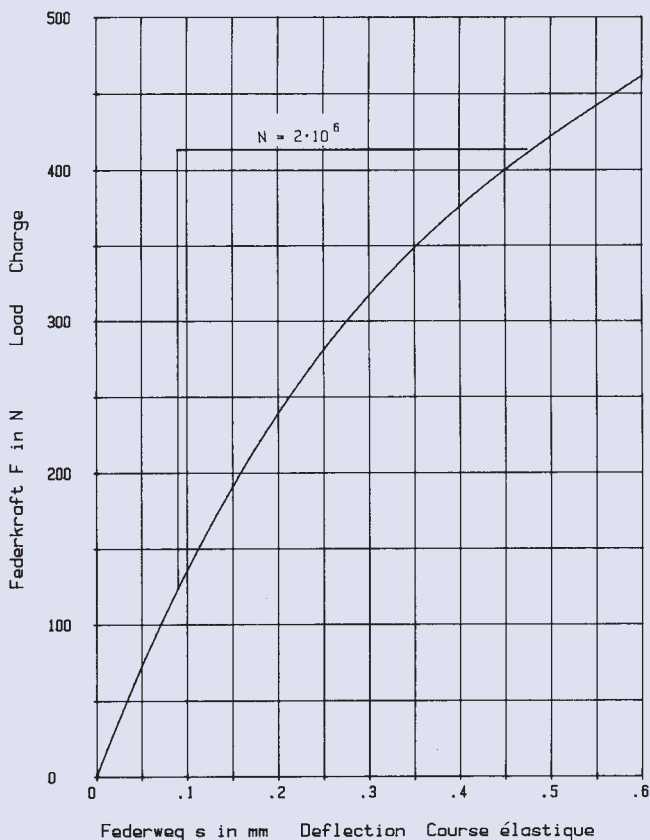

$h_0 = 0,6 \text{ mm}$        $D_e/D_i = 2,903$   
 $t = 0,6 \text{ mm}$        $D_e/t = 30$   
 $h_0/t = 1,0$        $m = 1,056 \text{ g}$

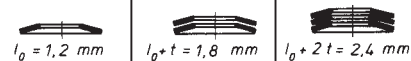

**18 x 6,2 x 0,7**

**GR 1**

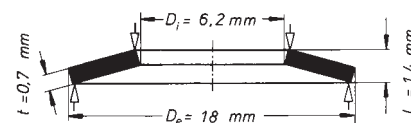
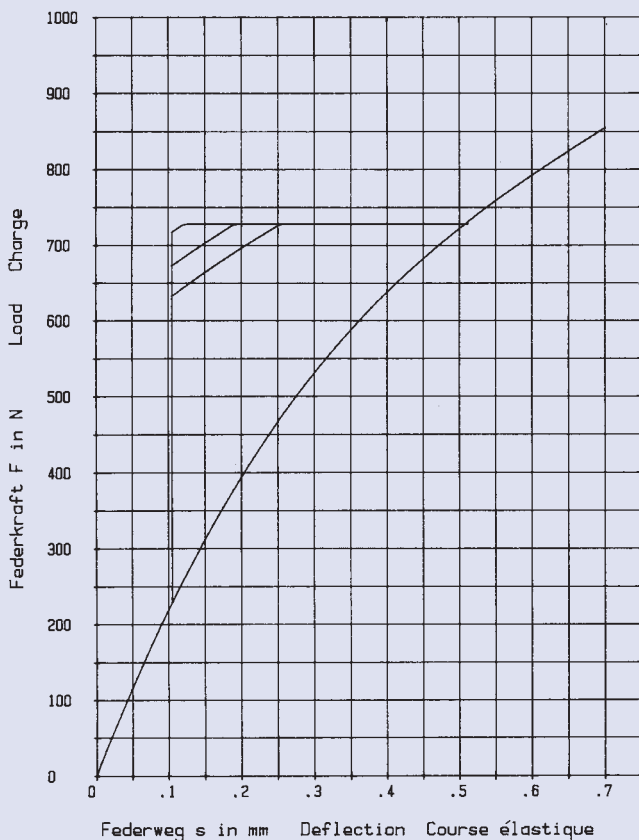

$h_0 = 0,7 \text{ mm}$        $D_e/D_i = 2,903$   
 $t = 0,7 \text{ mm}$        $D_e/t = 25,714$   
 $h_0/t = 1,0$        $m = 1,232 \text{ g}$

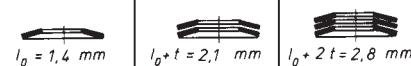

18 x 6,2 x 0,8

GR 1

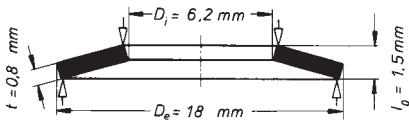

$h_0 = 0,7 \text{ mm}$        $D_e/D_i = 2,903$   
 $t = 0,8 \text{ mm}$        $D_e/t = 22,5$   
 $h_0/t = 0,875$        $m = 1,408 \text{ g}$

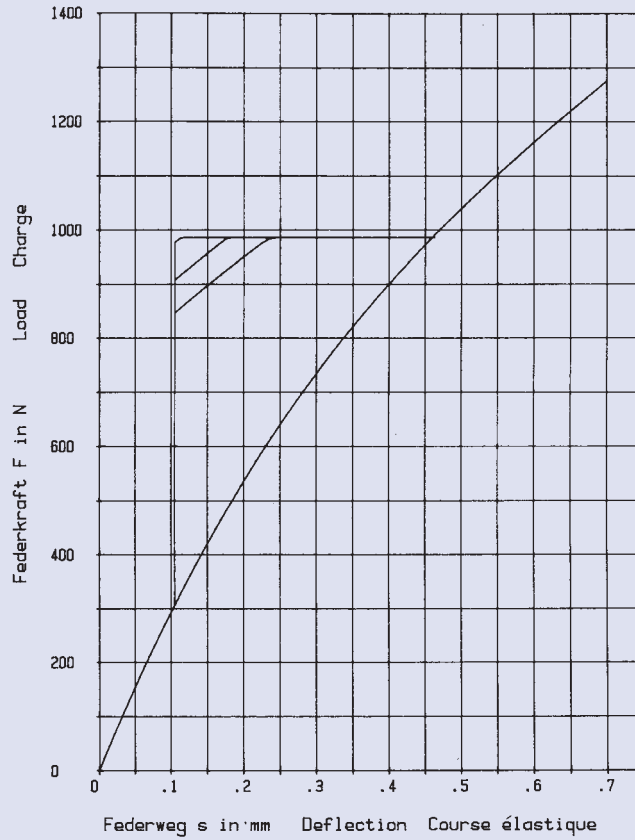
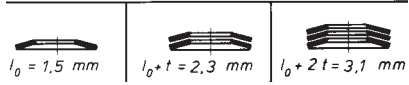

18 x 8,2 x 0,7

GR 1

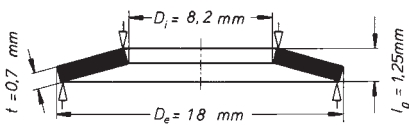

$h_0 = 0,55 \text{ mm}$        $D_e/D_i = 2,195$   
 $t = 0,7 \text{ mm}$        $D_e/t = 25,714$   
 $h_0/t = 0,785$        $m = 1,108 \text{ g}$

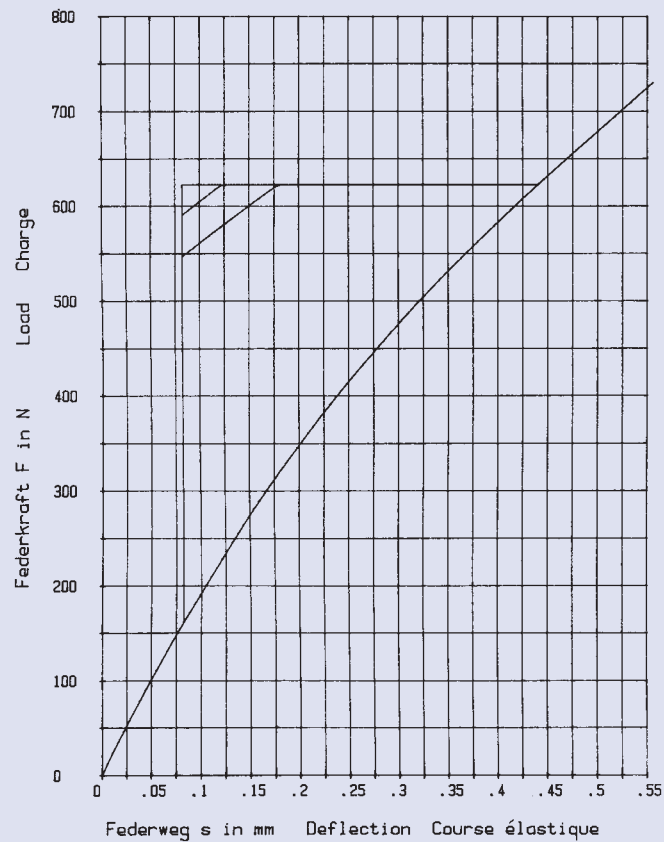
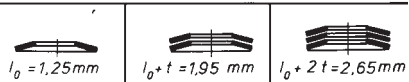

18 x 8,2 x 0,8

GR 1

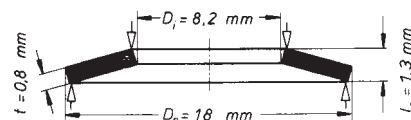
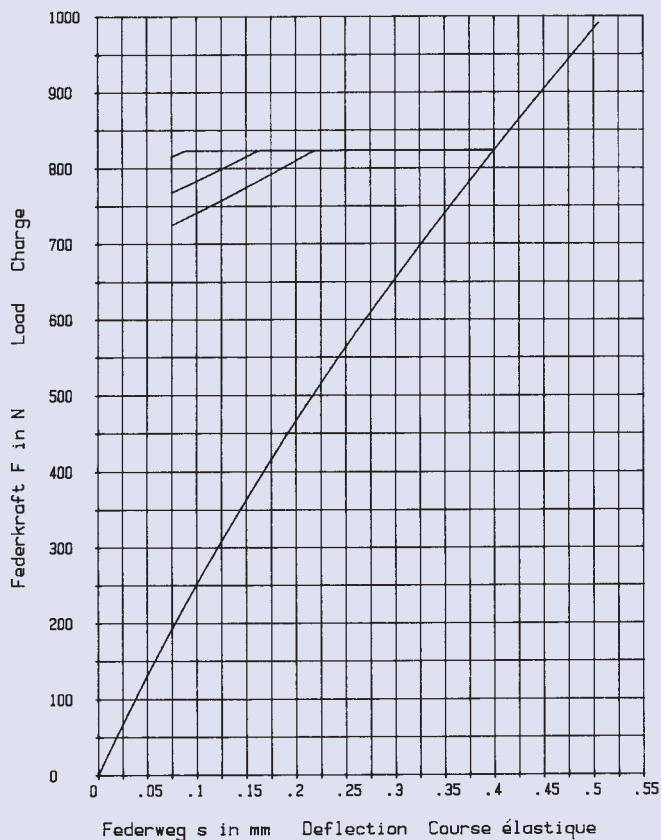

$h_0 = 0,5 \text{ mm}$        $D_e/D_i = 2,195$   
 $t = 0,8 \text{ mm}$        $D_e/t = 22,5$   
 $h_0/t = 0,625$        $m = 1,266 \text{ g}$

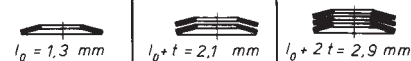

18 x 8,2 x 1,0

GR 1

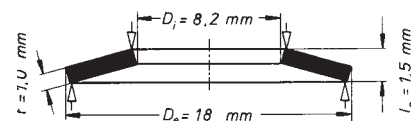
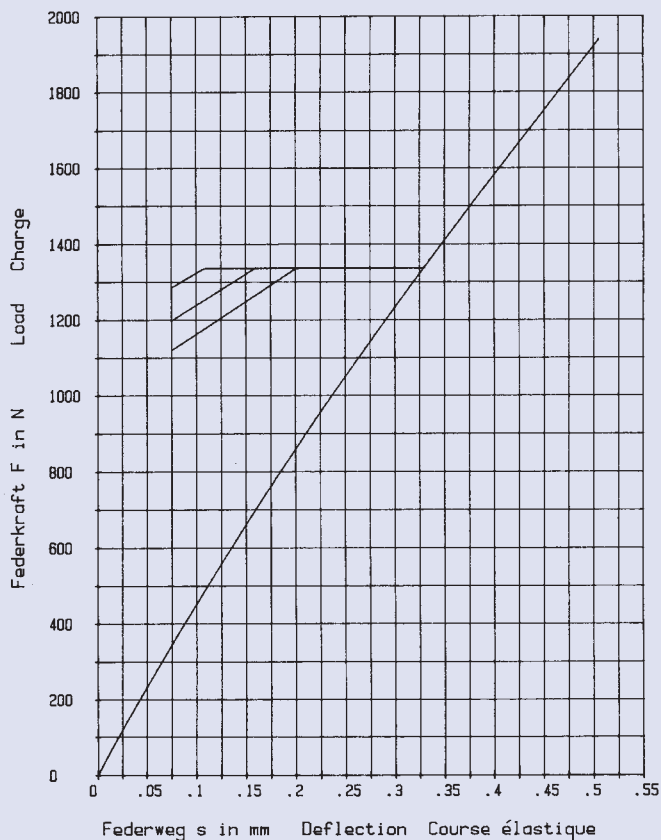

$h_0 = 0,5 \text{ mm}$        $D_e/D_i = 2,195$   
 $t = 1,0 \text{ mm}$        $D_e/t = 18$   
 $h_0/t = 0,5$        $m = 1,582 \text{ g}$



18 x 9,2 x 0,45

GR 1, DIN 2093 – C 18

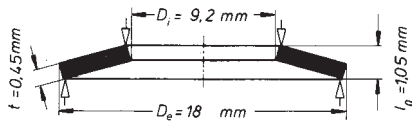

$h_0 = 0,6 \text{ mm}$        $D_e/D_i = 1,956$   
 $t = 0,45 \text{ mm}$        $D_e/t = 40$   
 $h_0/t = 1,333$        $m = 0,664 \text{ g}$

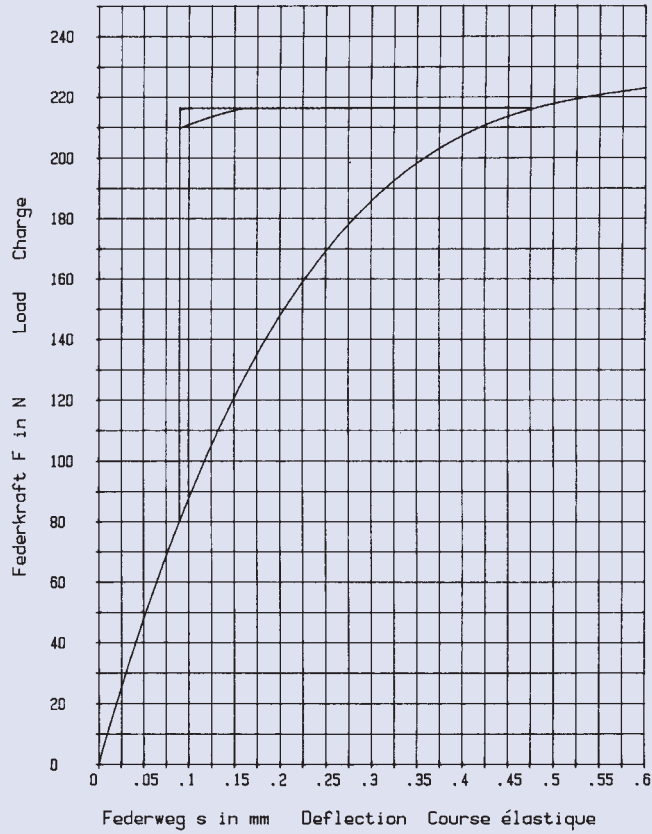
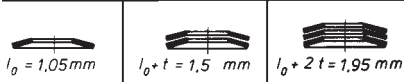

18 x 9,2 x 0,7

GR 1, DIN 2093 – B 18

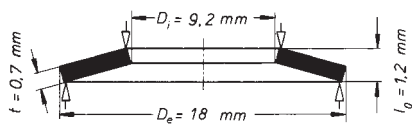

$h_0 = 0,5 \text{ mm}$        $D_e/D_i = 1,956$   
 $t = 0,7 \text{ mm}$        $D_e/t = 25,714$   
 $h_0/t = 0,714$        $m = 1,033 \text{ g}$

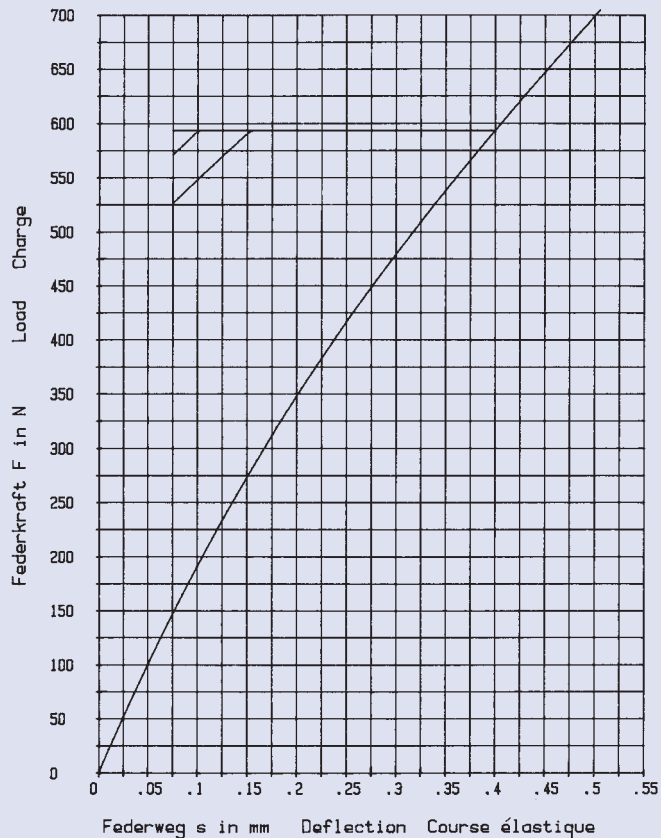
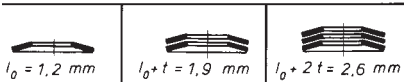

18 x 9,2 x 1,0

GR 1, DIN 2093 – A 18

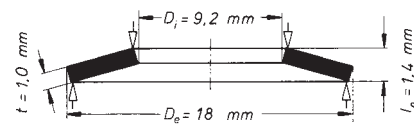
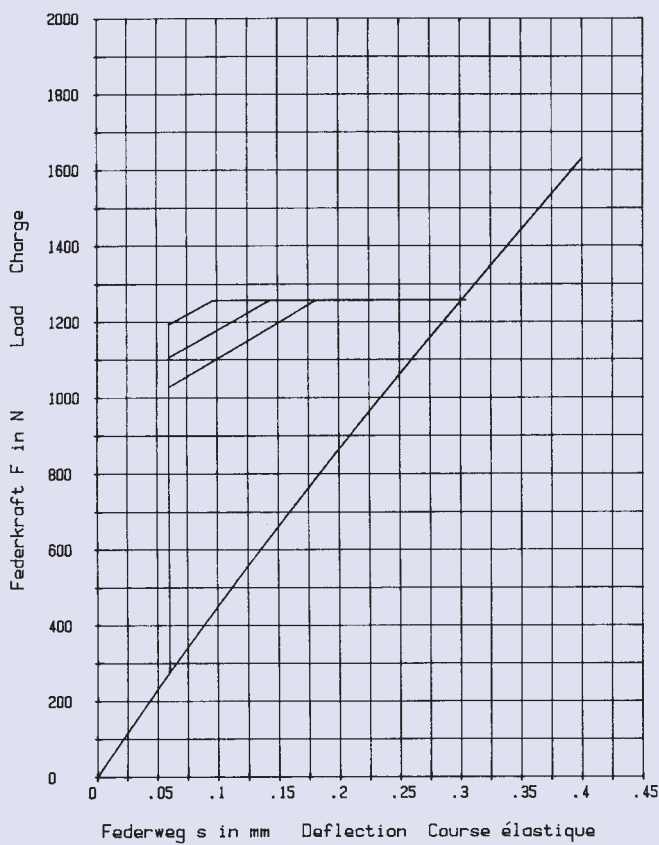

$h_0 = 0,4 \text{ mm}$        $D_e/D_i = 1,956$   
 $t = 1,0 \text{ mm}$        $D_e/t = 18$   
 $h_0/t = 0,4$        $m = 1,476 \text{ g}$

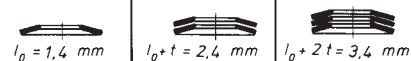

20 x 8,2 x 0,5

GR 1

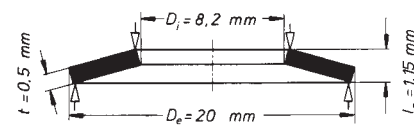
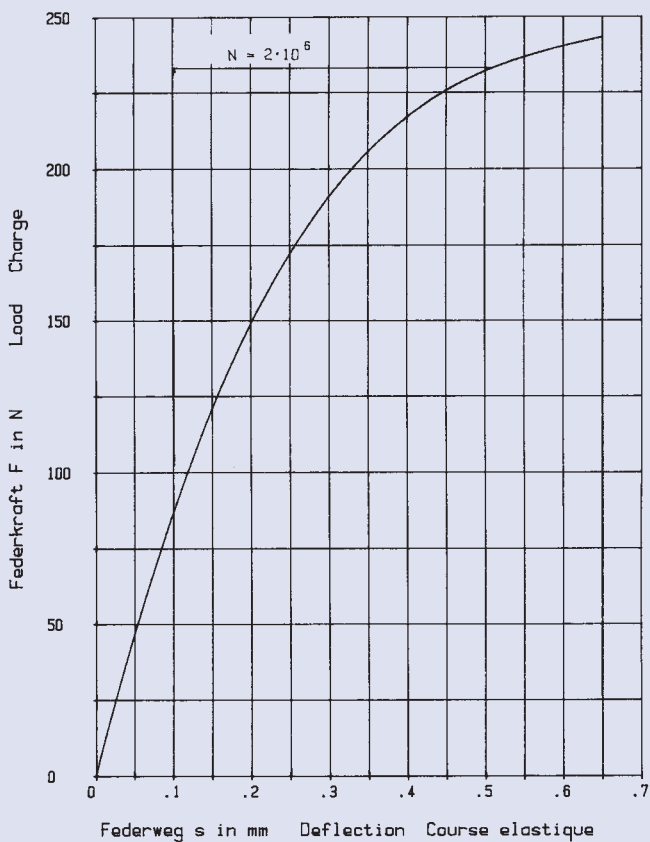

$h_0 = 0,65 \text{ mm}$        $D_e/D_i = 2,439$   
 $t = 0,5 \text{ mm}$        $D_e/t = 40$   
 $h_0/t = 1,3$        $m = 1,026 \text{ g}$

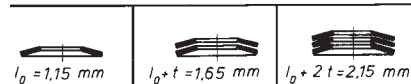

20 x 8,2 x 0,6

GR 1

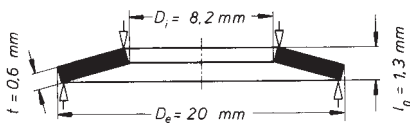

$h_0 = 0,7 \text{ mm}$        $D_e/D_i = 2,439$   
 $t = 0,6 \text{ mm}$        $D_e/t = 33,333$   
 $h_0/t = 1,166$        $m = 1,231 \text{ g}$

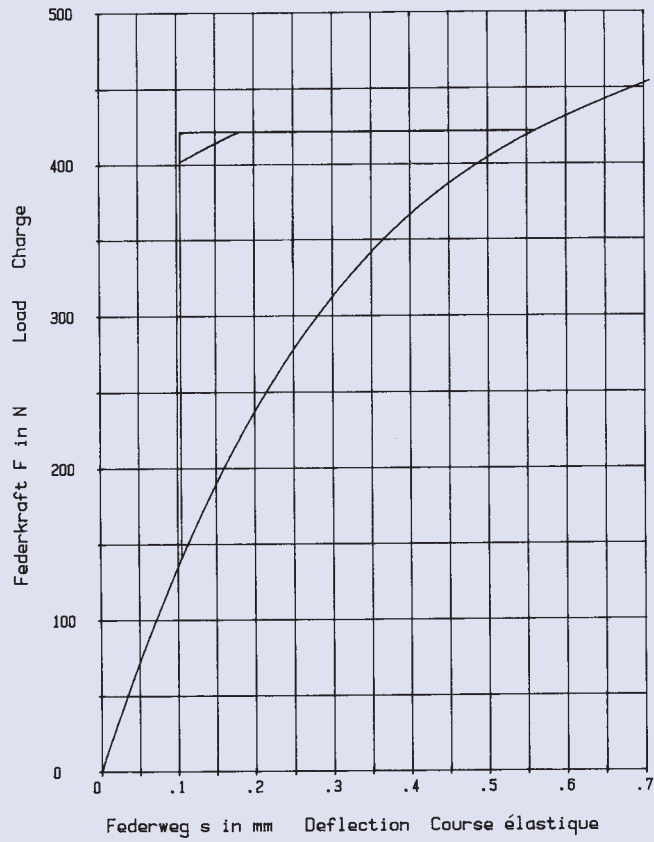
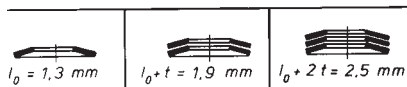

20 x 8,2 x 0,7

GR 1

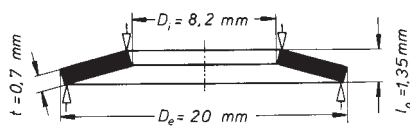

$h_0 = 0,65 \text{ mm}$        $D_e/D_i = 2,439$   
 $t = 0,7 \text{ mm}$        $D_e/t = 28,571$   
 $h_0/t = 0,928$        $m = 1,436 \text{ g}$

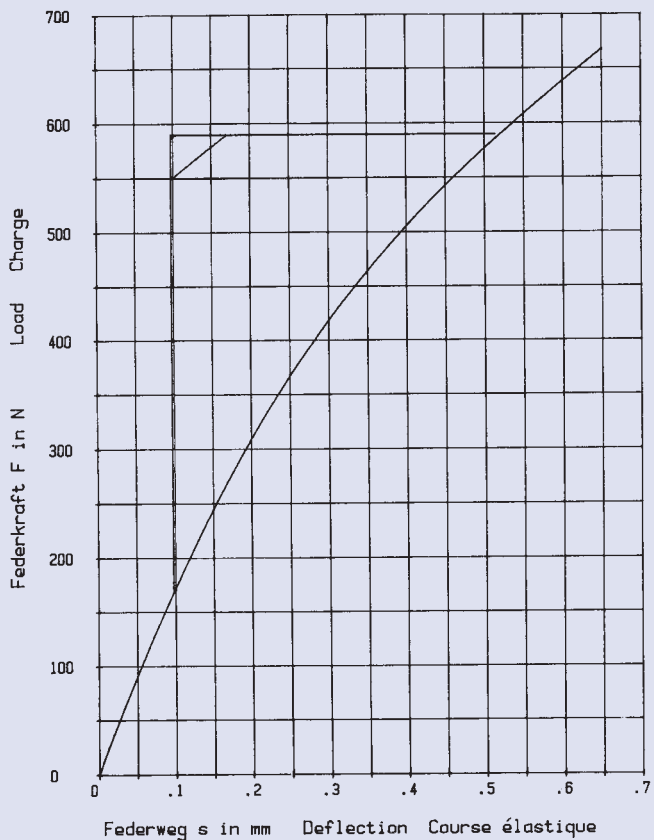
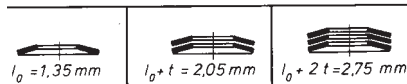

20 x 8,2 x 0,8

GR 1

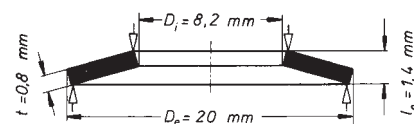
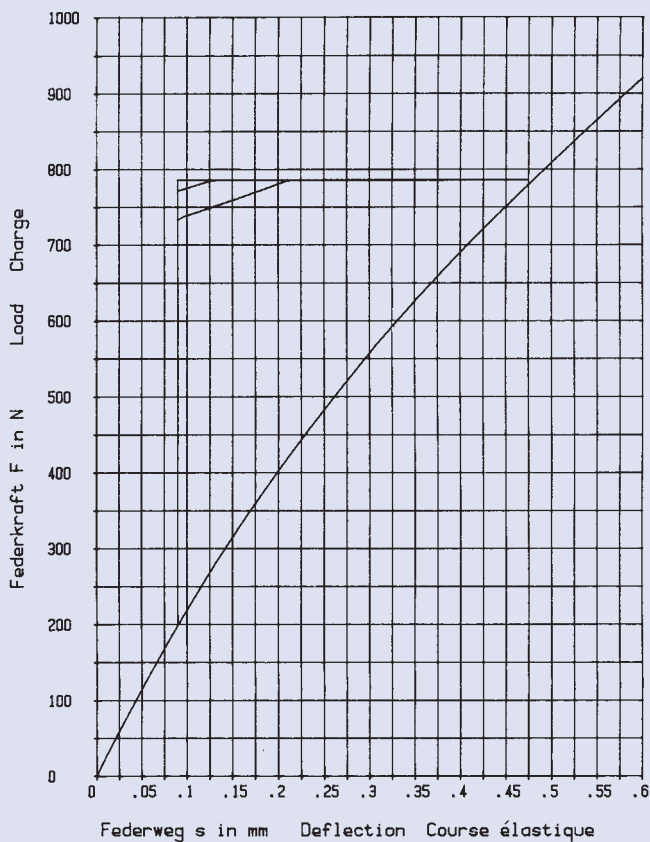

$h_0 = 0,6 \text{ mm}$        $D_e/D_i = 2,439$   
 $t = 0,8 \text{ mm}$        $D_e/t = 25$   
 $h_0/t = 0,75$        $m = 1,641 \text{ g}$



20 x 8,2 x 0,9

GR 1

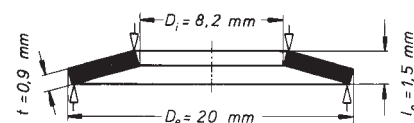
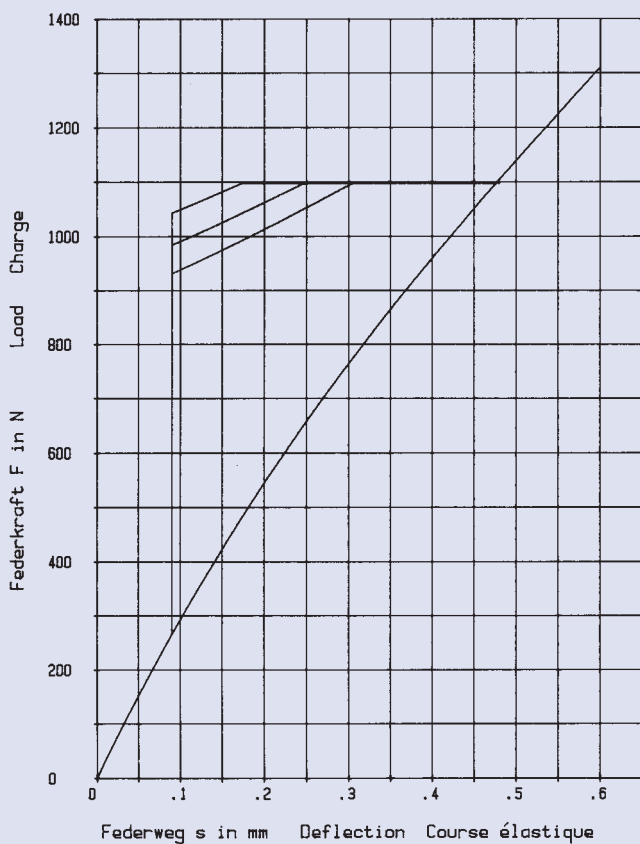

$h_0 = 0,6 \text{ mm}$        $D_e/D_i = 2,439$   
 $t = 0,9 \text{ mm}$        $D_e/t = 22,222$   
 $h_0/t = 0,666$        $m = 1,846 \text{ g}$



20 x 8,2 x 1,0

GR 1

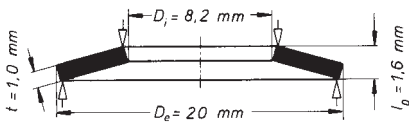

$h_0 = 0,6 \text{ mm}$        $D_e/D_i = 2,439$   
 $t = 1,0 \text{ mm}$        $D_e/t = 20$   
 $h_0/t = 0,6$        $m = 2,051 \text{ g}$

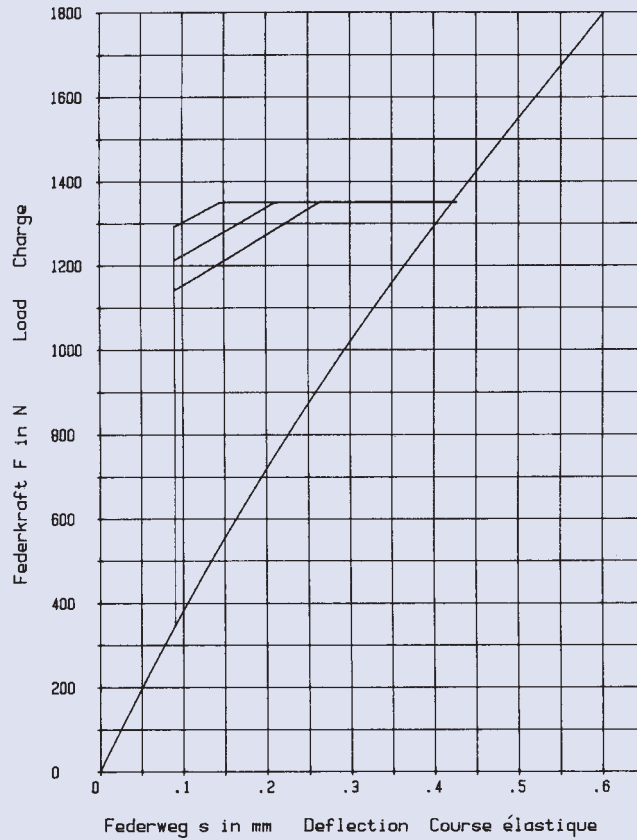
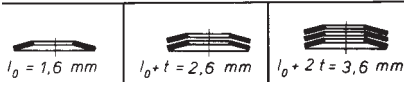

20 x 10,2 x 0,4

GR 1

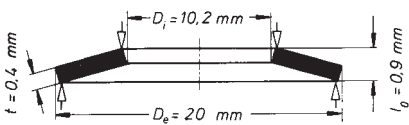

$h_0 = 0,5 \text{ mm}$        $D_e/D_i = 1,96$   
 $t = 0,4 \text{ mm}$        $D_e/t = 50$   
 $h_0/t = 1,25$        $m = 0,73 \text{ g}$

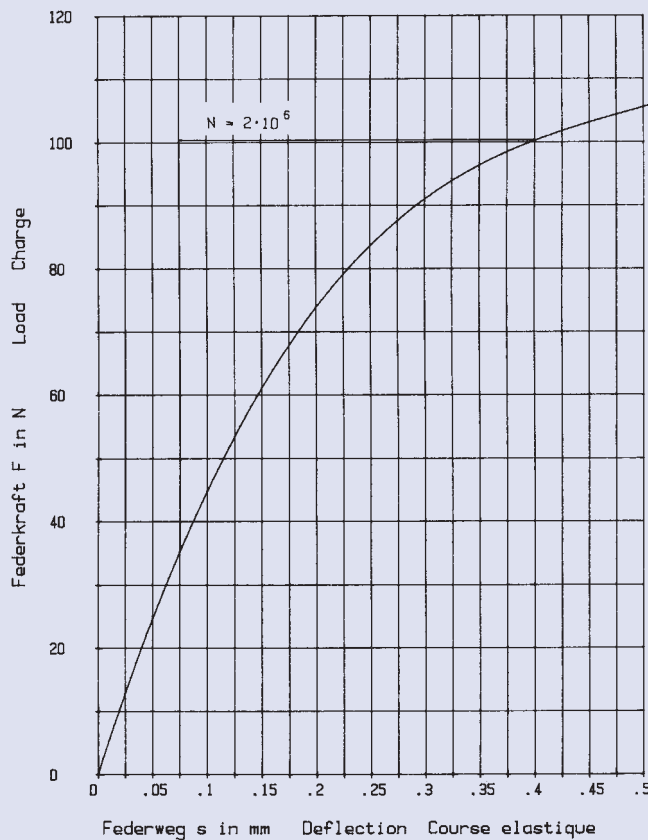
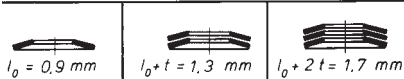



20 x 10,2 x 0,5

GR 1, DIN 2093 – C 20

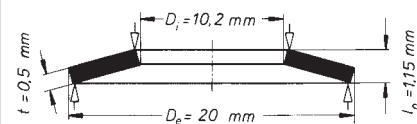
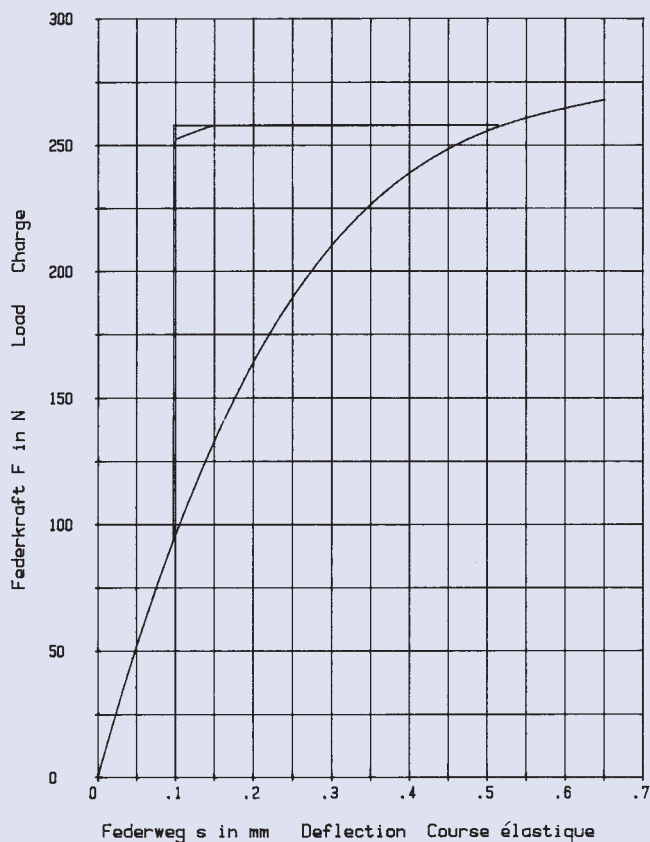

$h_0 = 0,65 \text{ mm}$        $D_e / D_i = 1,96$   
 $t = 0,5 \text{ mm}$        $D_e / t = 40$   
 $h_0 / t = 1,3$        $m = 0,912 \text{ g}$



20 x 10,2 x 0,8

GR 1, DIN 2093 – B 20

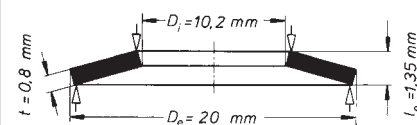
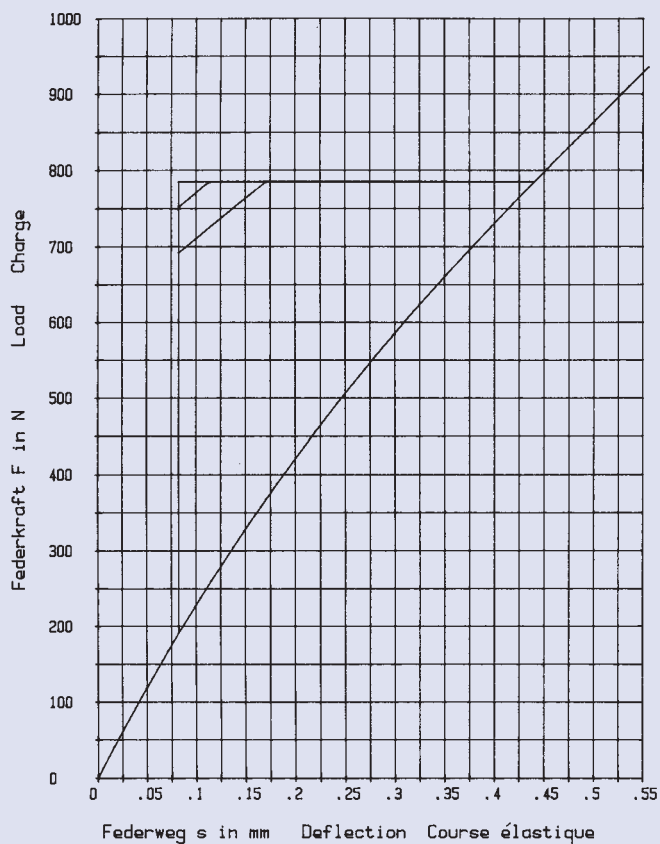

$h_0 = 0,55 \text{ mm}$        $D_e / D_i = 1,96$   
 $t = 0,8 \text{ mm}$        $D_e / t = 25$   
 $h_0 / t = 0,687$        $m = 1,46 \text{ g}$

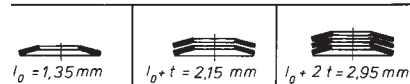

20 x 10,2 x 0,9

GR 1

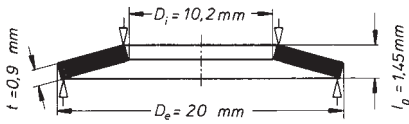

$h_0 = 0,55 \text{ mm}$        $D_e / D_i = 1,96$   
 $t = 0,9 \text{ mm}$        $D_e / t = 22,222$   
 $h_0 / t = 0,611$        $m = 1,642 \text{ g}$

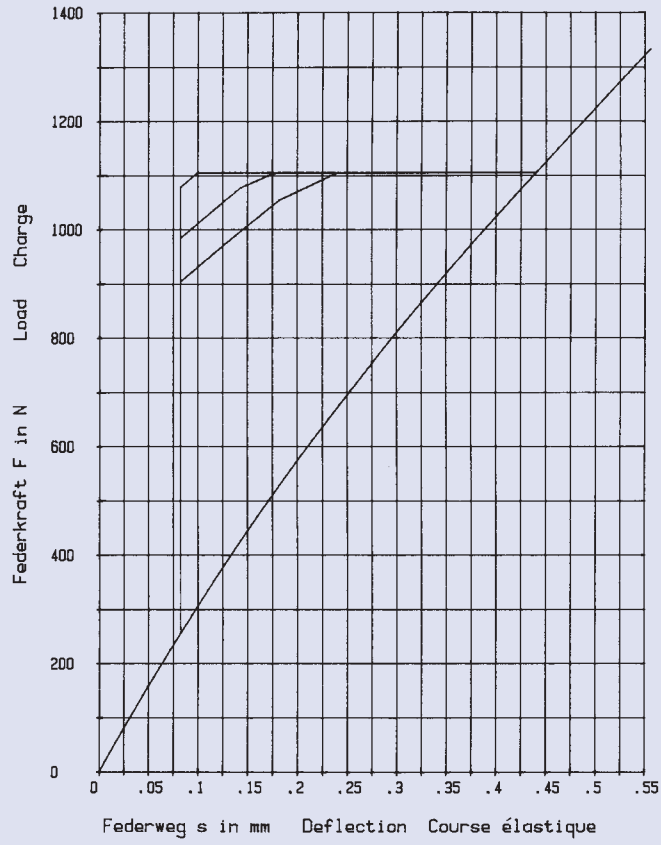
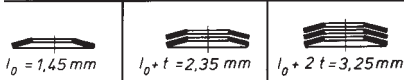

20 x 10,2 x 1,0

GR 1

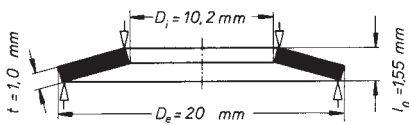

$h_0 = 0,55 \text{ mm}$        $D_e / D_i = 1,96$   
 $t = 1,0 \text{ mm}$        $D_e / t = 20$   
 $h_0 / t = 0,55$        $m = 1,824 \text{ g}$

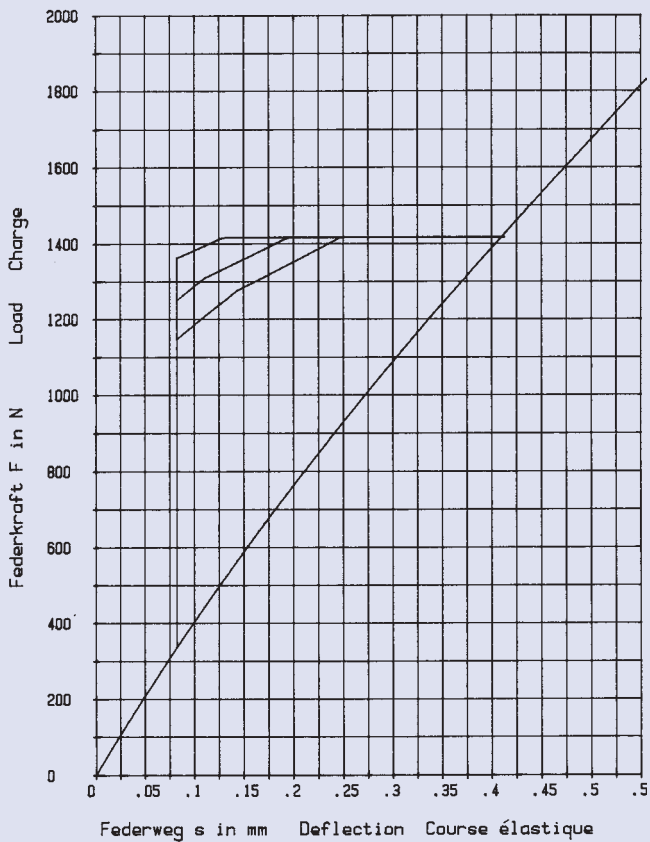
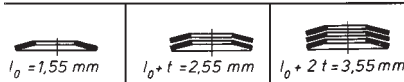

20 x 10,2 x 1,1

GR 1, DIN 2093 – A 20

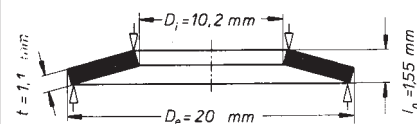
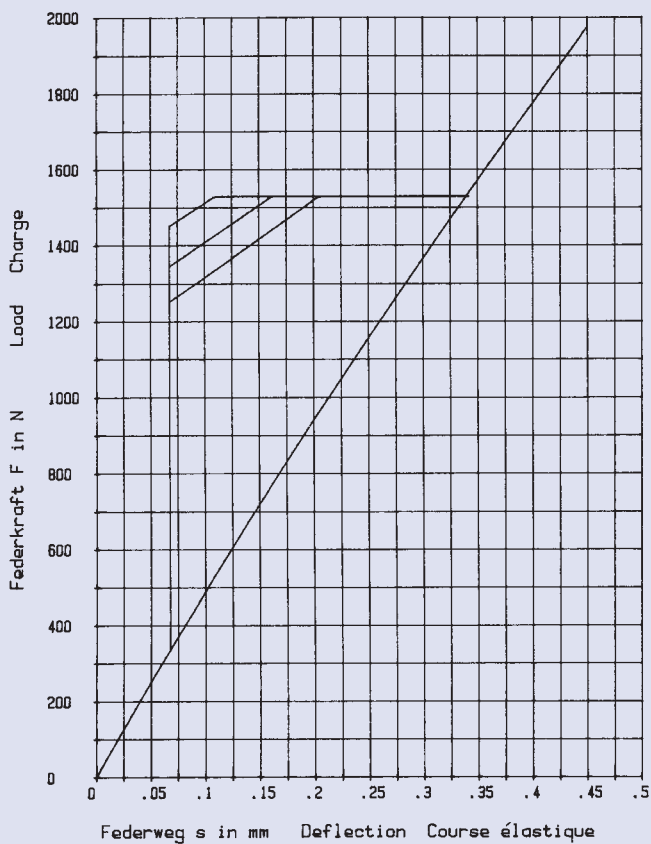

$h_0 = 0,45 \text{ mm}$        $D_e/D_i = 1,96$   
 $t = 1,1 \text{ mm}$        $D_e/t = 18,181$   
 $h_0/t = 0,409$        $m = 2,007 \text{ g}$



22,5 x 11,2 x 0,6

GR 1, DIN 2093 – C 22,5

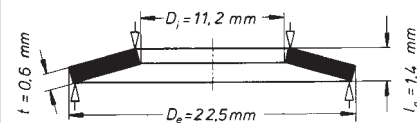
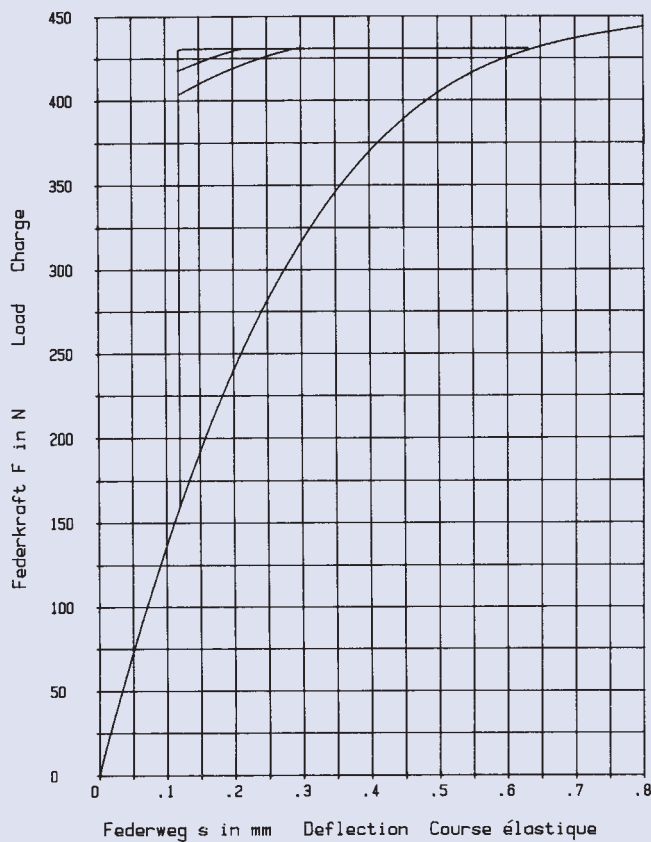

$h_0 = 0,8 \text{ mm}$        $D_e/D_i = 2,008$   
 $t = 0,6 \text{ mm}$        $D_e/t = 37,5$   
 $h_0/t = 1,333$        $m = 1,409 \text{ g}$

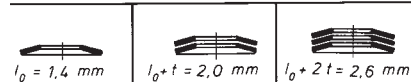

22,5 x 11,2 x 0,8

GR 1, DIN 2093 – B 22,5

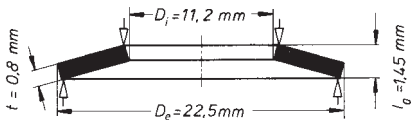

$h_0 = 0,65 \text{ mm}$        $D_e / D_i = 2,008$   
 $t = 0,8 \text{ mm}$        $D_e / t = 28,125$   
 $h_0 / t = 0,812$        $m = 1,878 \text{ g}$

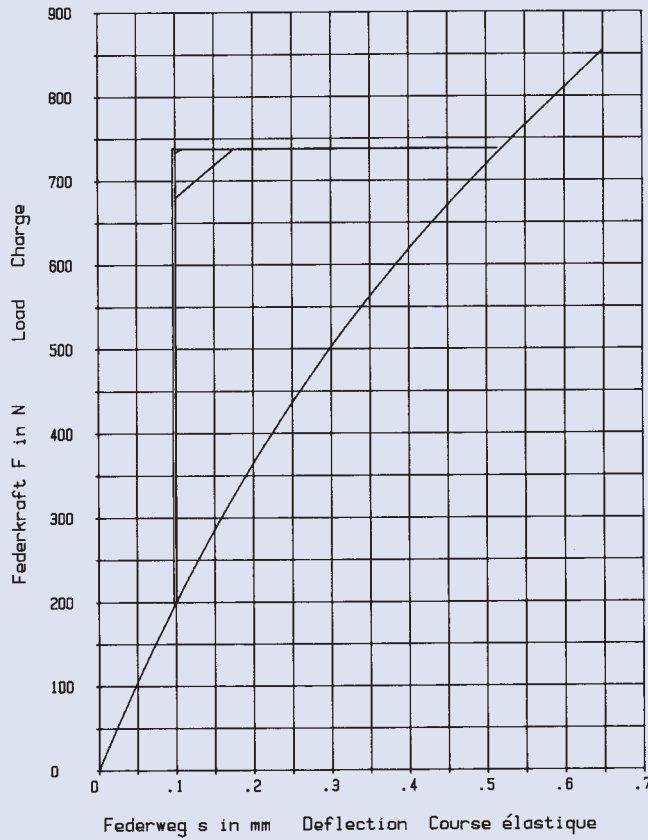
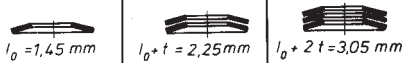

22,5 x 11,2 x 1,25

GR 1, DIN 2093 – A 22,5

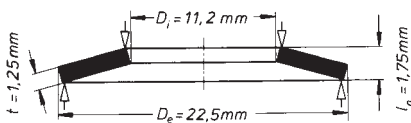

$h_0 = 0,5 \text{ mm}$        $D_e / D_i = 2,008$   
 $t = 1,25 \text{ mm}$        $D_e / t = 18$   
 $h_0 / t = 0,4$        $m = 2,935 \text{ g}$

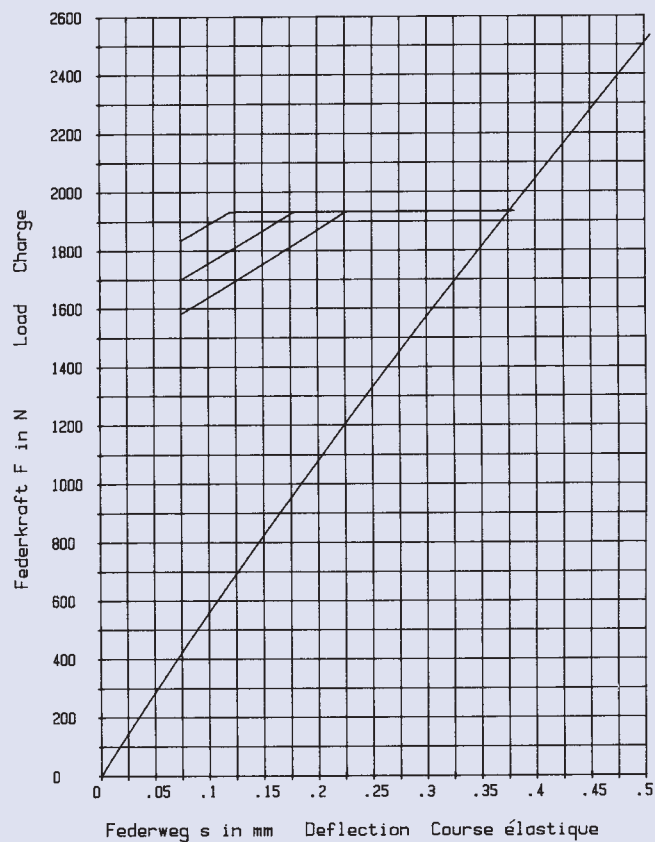
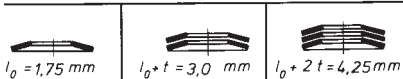

23 x 8,2 x 0,7

GR 1

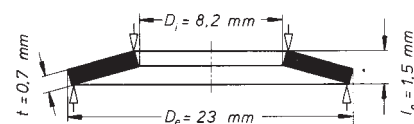
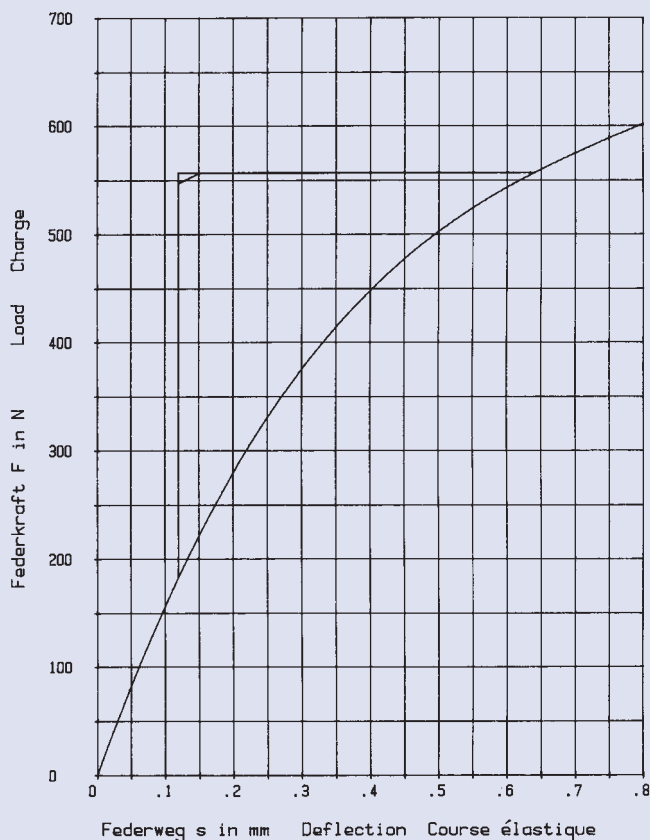

$h_0 = 0,8 \text{ mm}$        $D_e/D_i = 2,804$   
 $t = 0,7 \text{ mm}$        $D_e/t = 32,857$   
 $h_0/t = 1,142$        $m = 1,993 \text{ g}$



23 x 8,2 x 0,8

GR 1

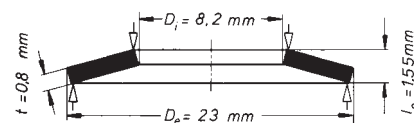
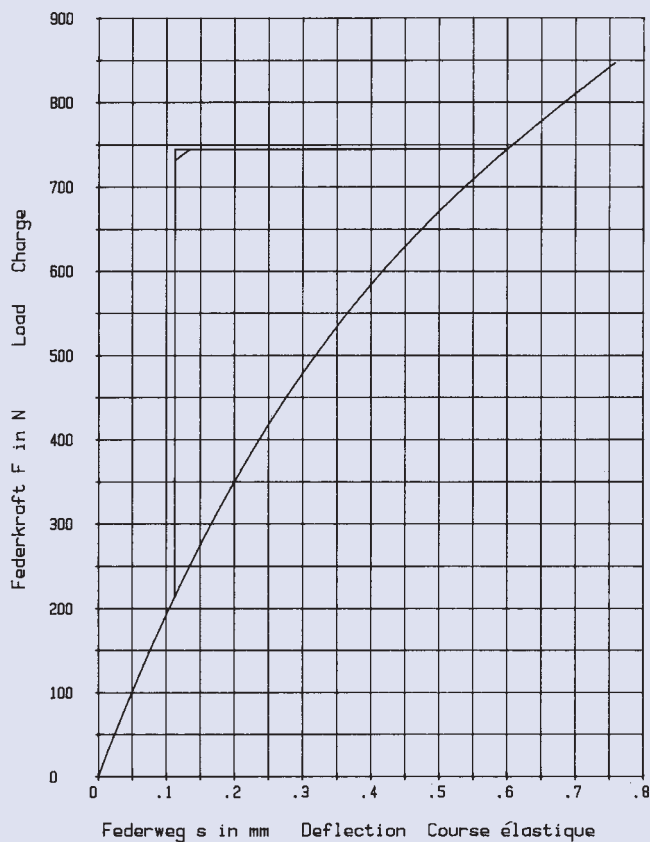

$h_0 = 0,75 \text{ mm}$        $D_e/D_i = 2,804$   
 $t = 0,8 \text{ mm}$        $D_e/t = 28,75$   
 $h_0/t = 0,937$        $m = 2,277 \text{ g}$

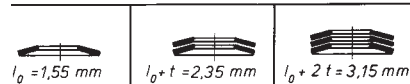

23 x 8,2 x 0,9

GR 1

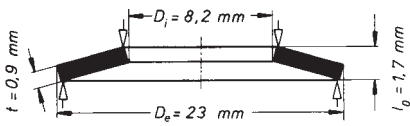

$h_0 = 0,8 \text{ mm}$        $D_e / D_i = 2,804$   
 $t = 0,9 \text{ mm}$        $D_e / t = 25,555$   
 $h_0 / t = 0,888$        $m = 2,561 \text{ g}$

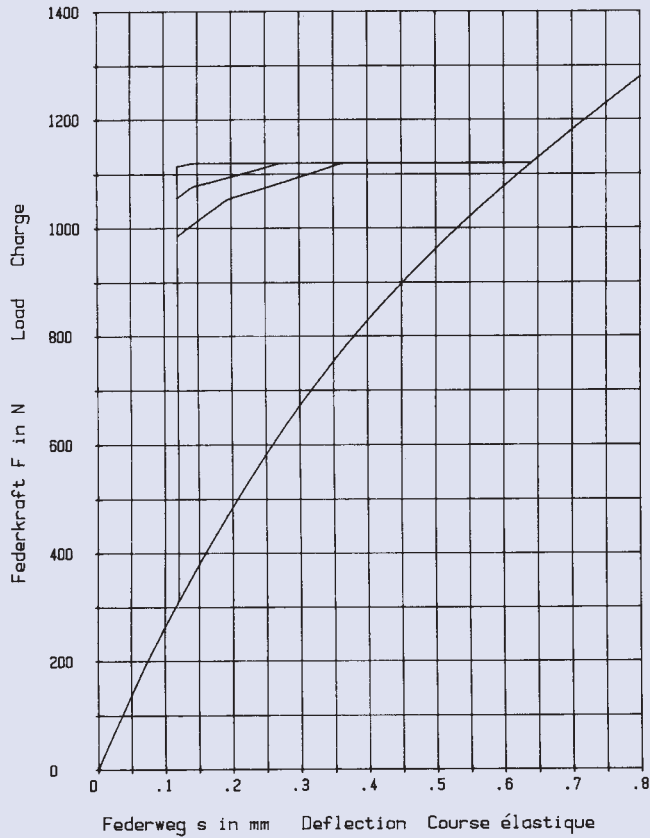
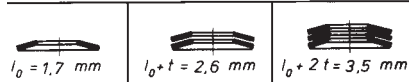

23 x 10,2 x 0,9

GR 1

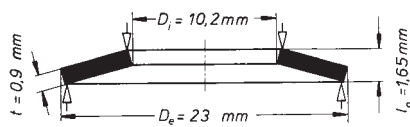

$h_0 = 0,75 \text{ mm}$        $D_e / D_i = 2,254$   
 $t = 0,9 \text{ mm}$        $D_e / t = 25,555$   
 $h_0 / t = 0,833$        $m = 2,357 \text{ g}$

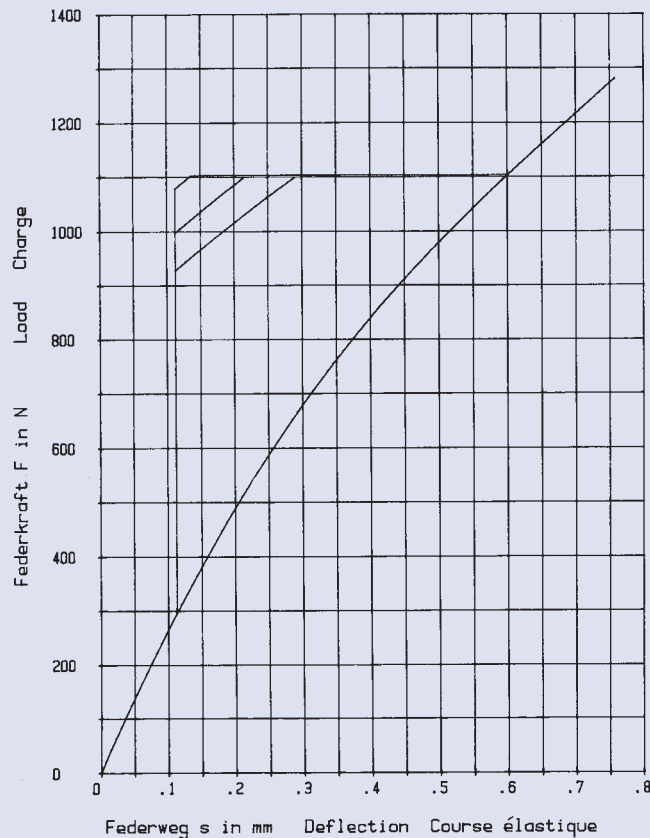
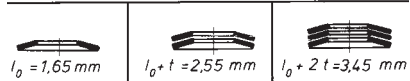

23 x 10,2 x 1,0

GR 1

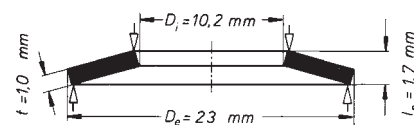
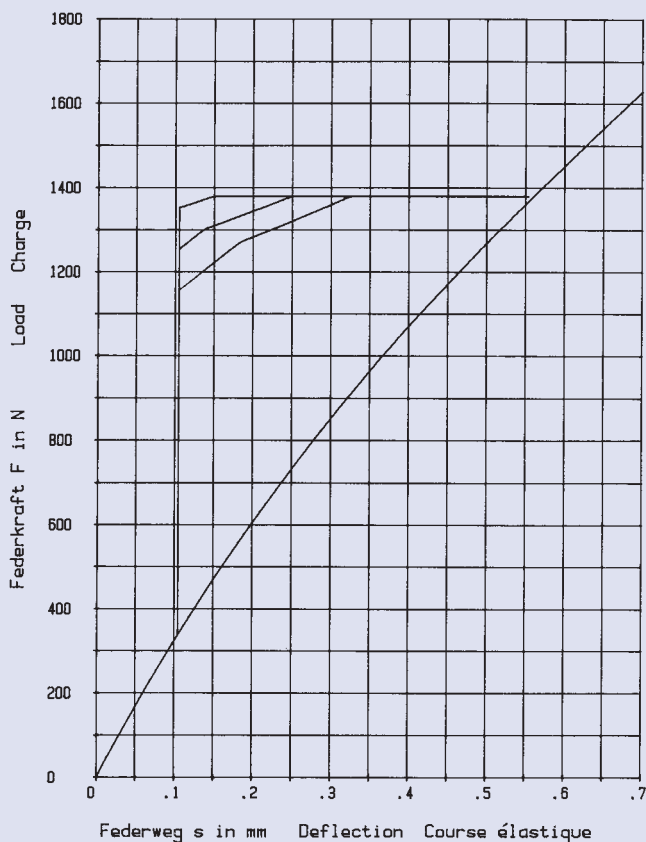

$h_0 = 0,7 \text{ mm}$        $D_e/D_i = 2,254$   
 $t = 1,0 \text{ mm}$        $D_e/t = 23$   
 $h_0/t = 0,7$        $m = 2,619 \text{ g}$



23 x 12,2 x 1,0

GR 1

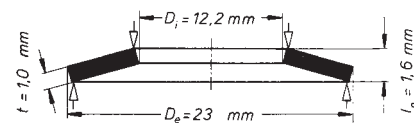
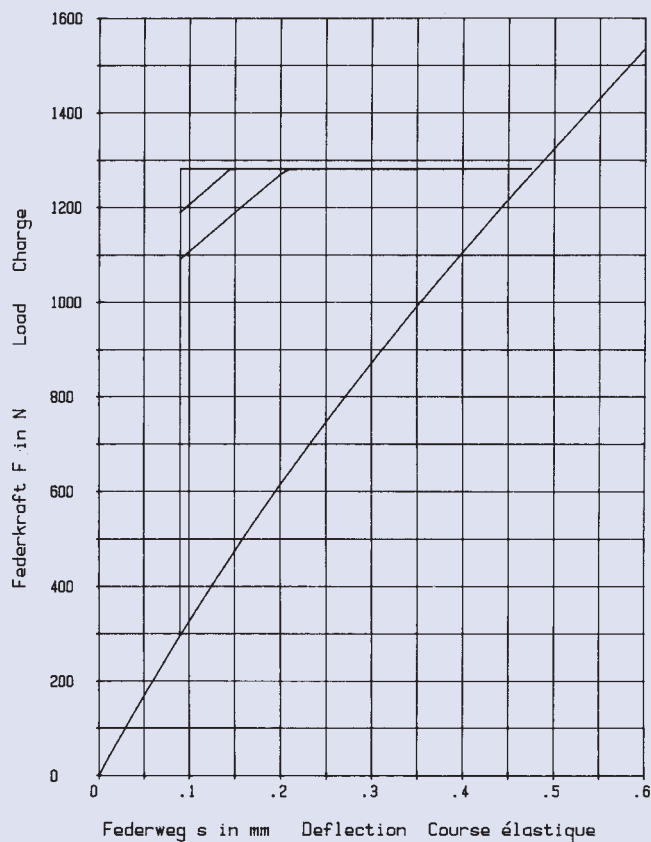

$h_0 = 0,6 \text{ mm}$        $D_e/D_i = 1,885$   
 $t = 1,0 \text{ mm}$        $D_e/t = 23$   
 $h_0/t = 0,6$        $m = 2,343 \text{ g}$

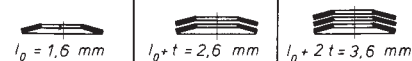

23 x 12,2 x 1,25

GR 2

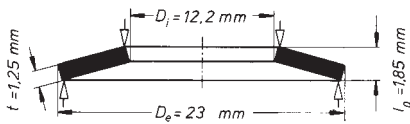

$h_0 = 0,6 \text{ mm}$        $D_e/D_i = 1,885$   
 $t = 1,25 \text{ mm}$        $D_e/t = 18,4$   
 $h_0/t = 0,48$        $m = 2,929 \text{ g}$

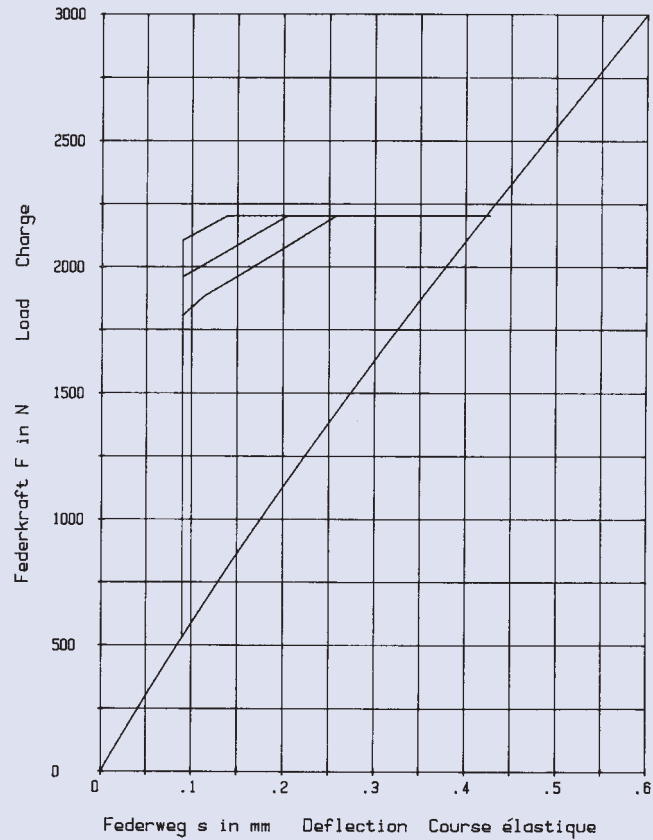
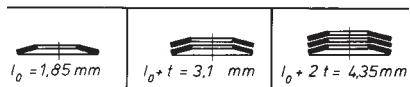

23 x 12,2 x 1,5

GR 2

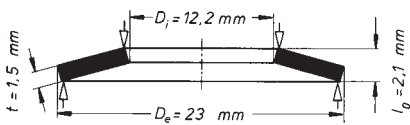

$h_0 = 0,6 \text{ mm}$        $D_e/D_i = 1,885$   
 $t = 1,5 \text{ mm}$        $D_e/t = 15,333$   
 $h_0/t = 0,4$        $m = 3,514 \text{ g}$

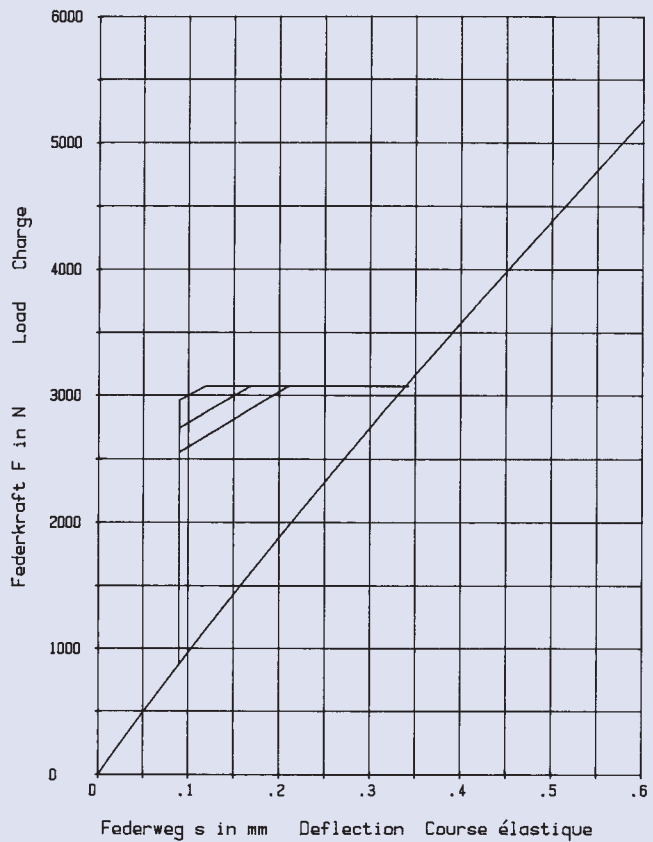
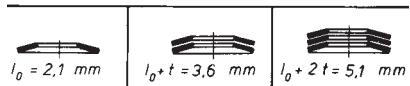



25 x 12,2 x 0,7

GR 1, DIN 2093 – C 25

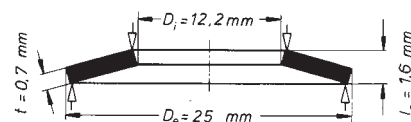
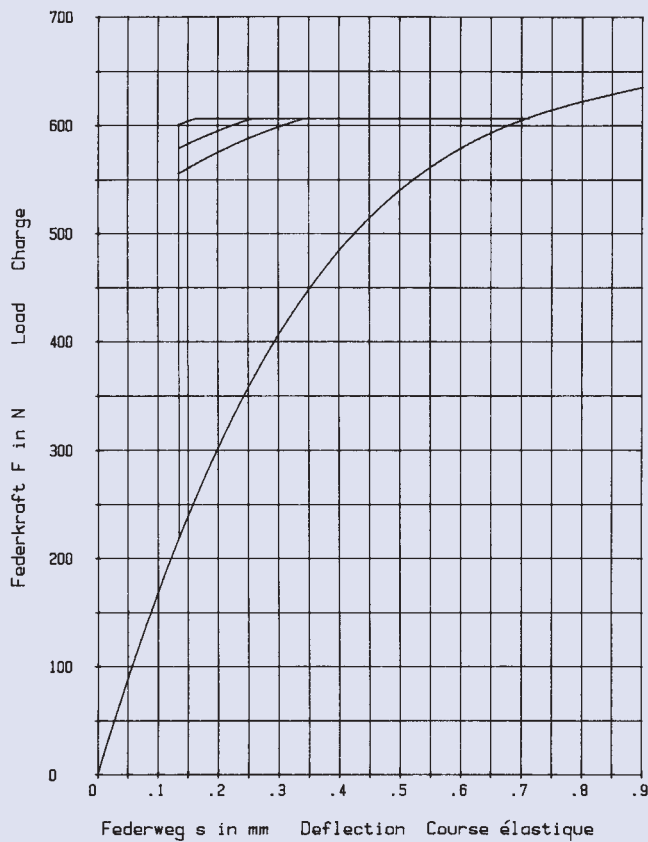

$h_0 = 0,9 \text{ mm}$        $D_e/D_i = 2,049$   
 $t = 0,7 \text{ mm}$        $D_e/t = 35,714$   
 $h_0/t = 1,285$        $m = 2,055 \text{ g}$



25 x 12,2 x 0,9

GR 1, DIN 2093 – B 25

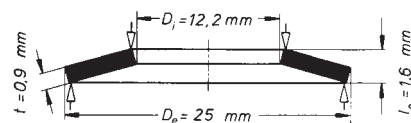
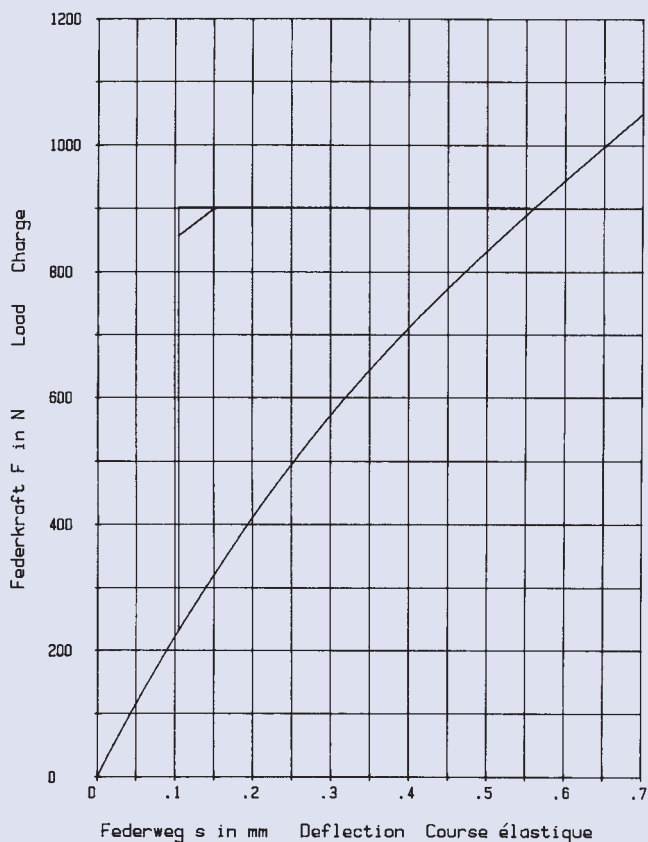

$h_0 = 0,7 \text{ mm}$        $D_e/D_i = 2,049$   
 $t = 0,9 \text{ mm}$        $D_e/t = 27,777$   
 $h_0/t = 0,777$        $m = 2,642 \text{ g}$

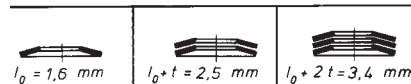

25 x 12,2 x 1,5

GR 2, DIN 2093 – A 25

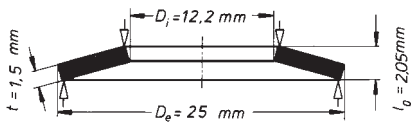

$h_0 = 0,55 \text{ mm}$        $D_e / D_i = 2,049$   
 $t = 1,5 \text{ mm}$        $D_e / t = 16,666$   
 $h_0 / t = 0,366$        $m = 4,403 \text{ g}$

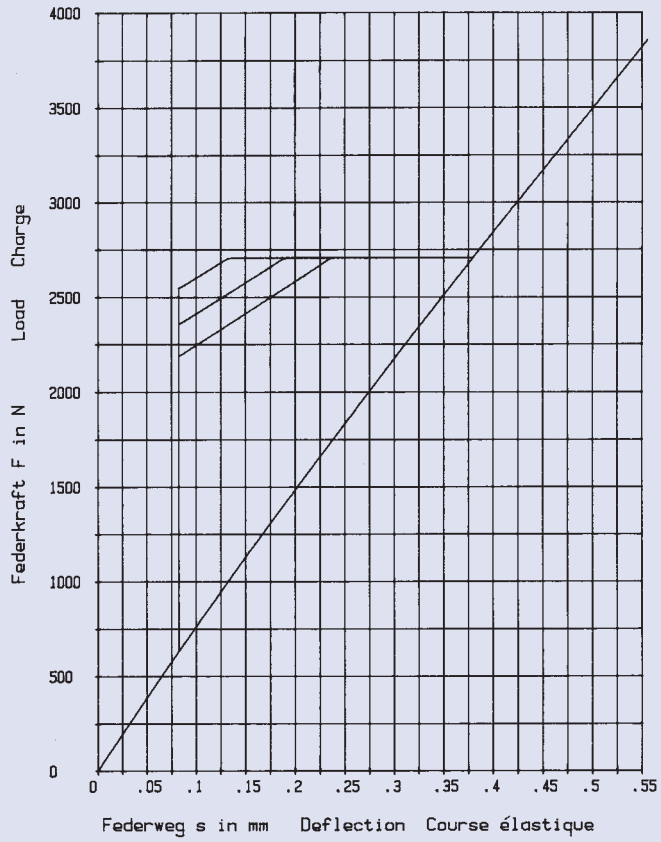
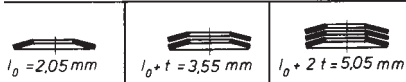

28 x 10,2 x 0,8

GR 1

$h_0 = 0,95 \text{ mm}$        $D_e / D_i = 2,745$   
 $t = 0,8 \text{ mm}$        $D_e / t = 35$   
 $h_0 / t = 1,187$        $m = 3,354 \text{ g}$

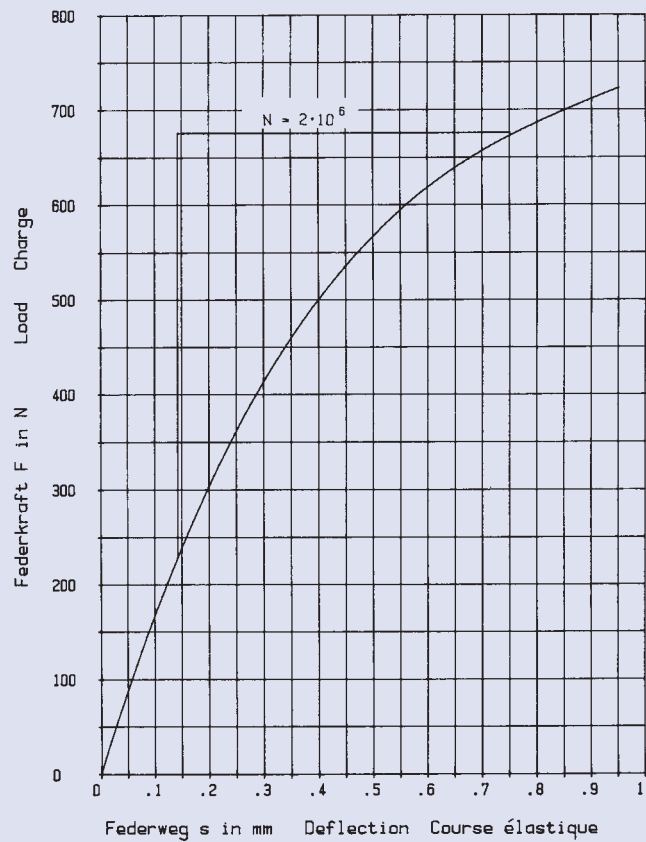
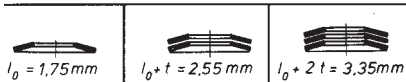

28 x 10,2 x 1,0

GR 1

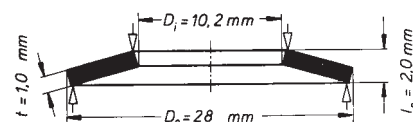
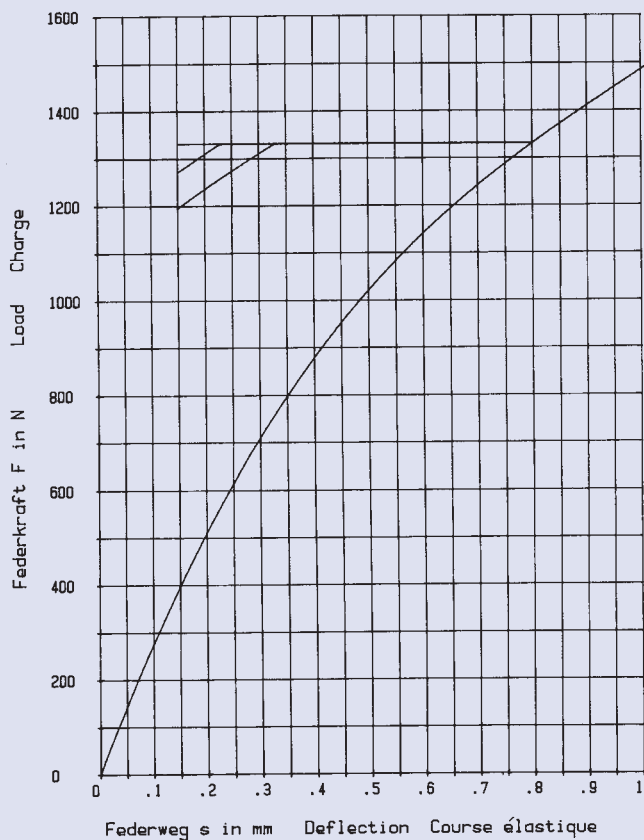

$h_0 = 1,0 \text{ mm}$   $D_e/D_i = 2,745$   
 $t = 1,0 \text{ mm}$   $D_e/t = 28$   
 $h_0/t = 1,0$   $m = 4,191 \text{ g}$

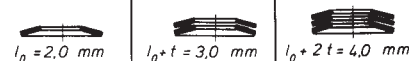

28 x 10,2 x 1,25

GR 2

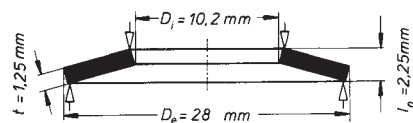
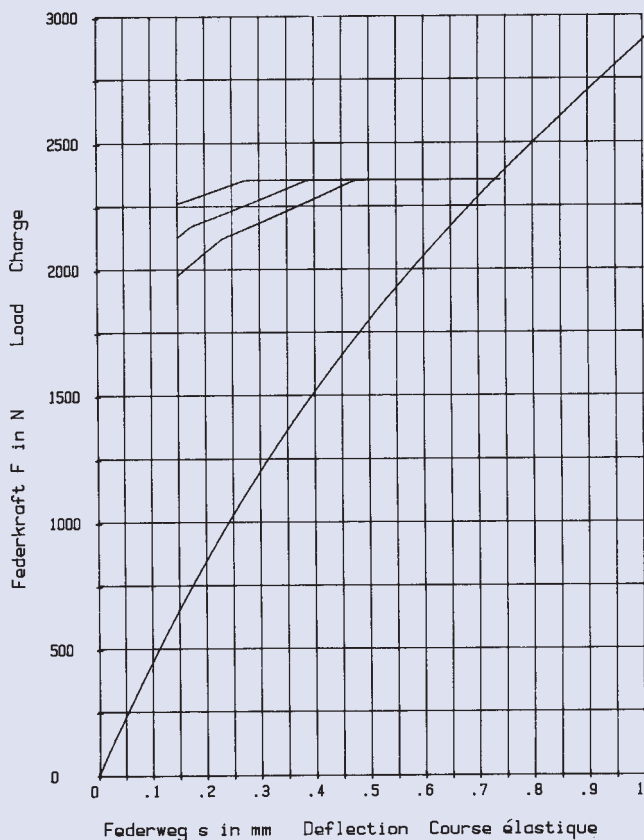

$h_0 = 1,0 \text{ mm}$   $D_e/D_i = 2,745$   
 $t = 1,25 \text{ mm}$   $D_e/t = 22,4$   
 $h_0/t = 0,8$   $m = 5,238 \text{ g}$

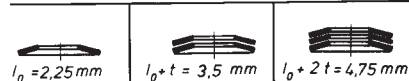

28 x 10,2 x 1,5

GR 2

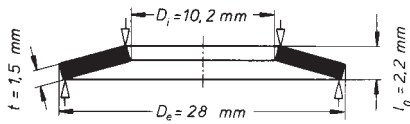

$h_0 = 0,7 \text{ mm}$        $D_e/D_i = 2,745$   
 $t = 1,5 \text{ mm}$        $D_e/t = 18,666$   
 $h_0/t = 0,466$        $m = 6,286 \text{ g}$

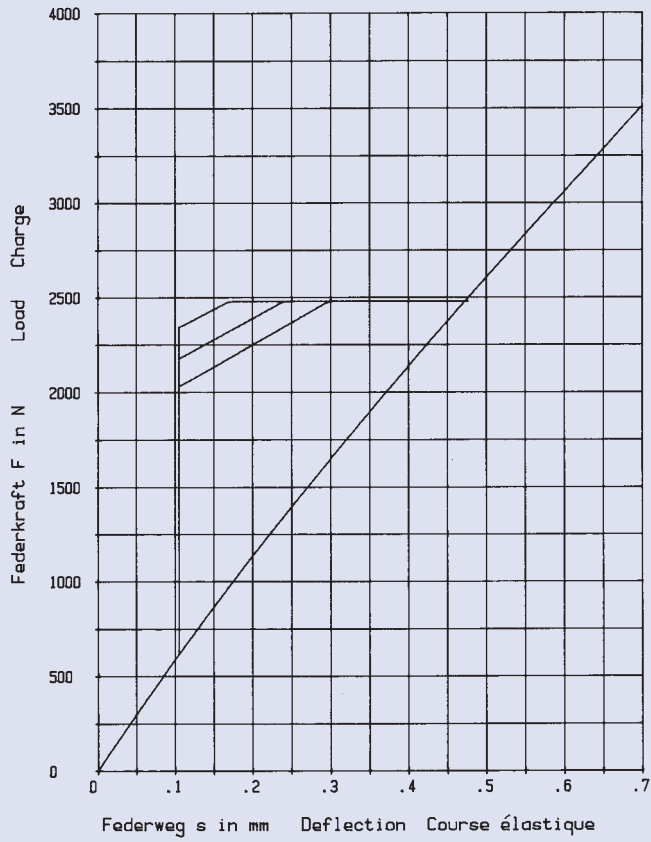
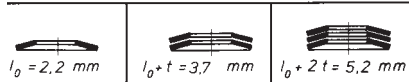

28 x 12,2 x 1,0

GR 1

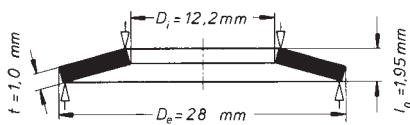

$h_0 = 0,95 \text{ mm}$        $D_e/D_i = 2,295$   
 $t = 1,0 \text{ mm}$        $D_e/t = 28$   
 $h_0/t = 0,95$        $m = 3,914 \text{ g}$

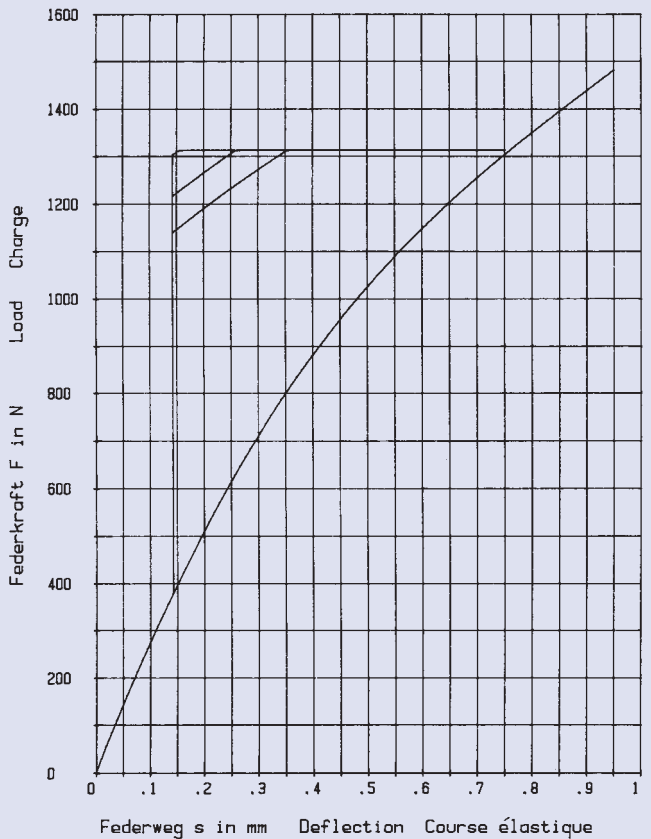
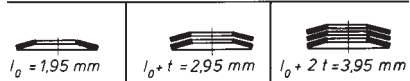

28 x 12,2 x 1,25

GR 2

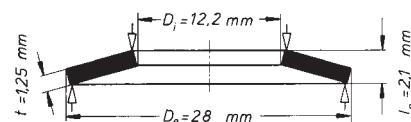
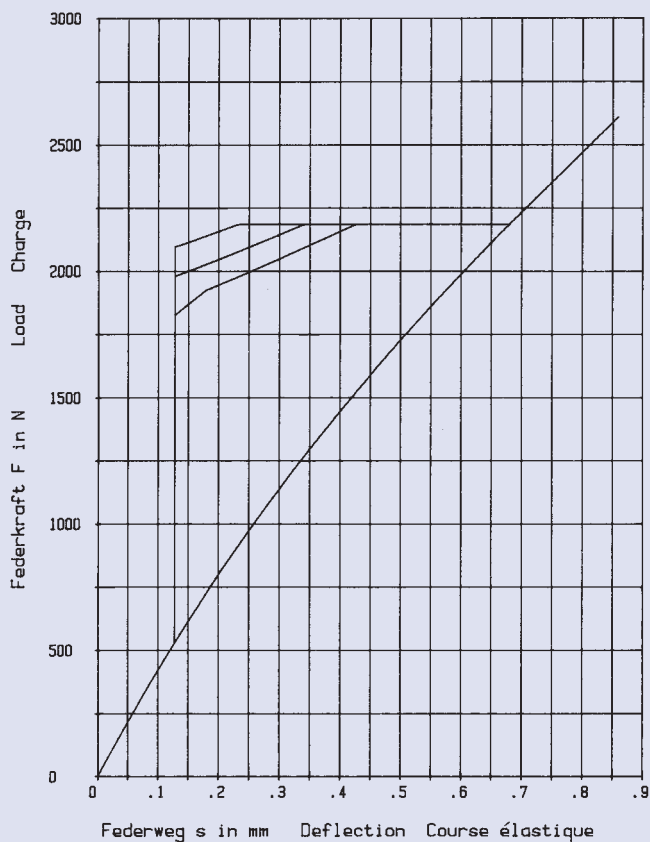

$h_0 = 0,85 \text{ mm}$        $D_e / D_i = 2,295$   
 $t = 1,25 \text{ mm}$        $D_e / t = 22,4$   
 $h_0 / t = 0,68$        $m = 4,893 \text{ g}$

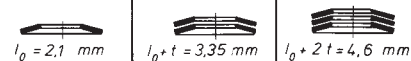

28 x 12,2 x 1,5

GR 2

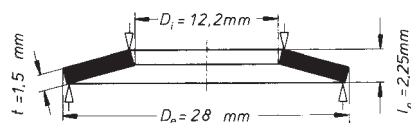
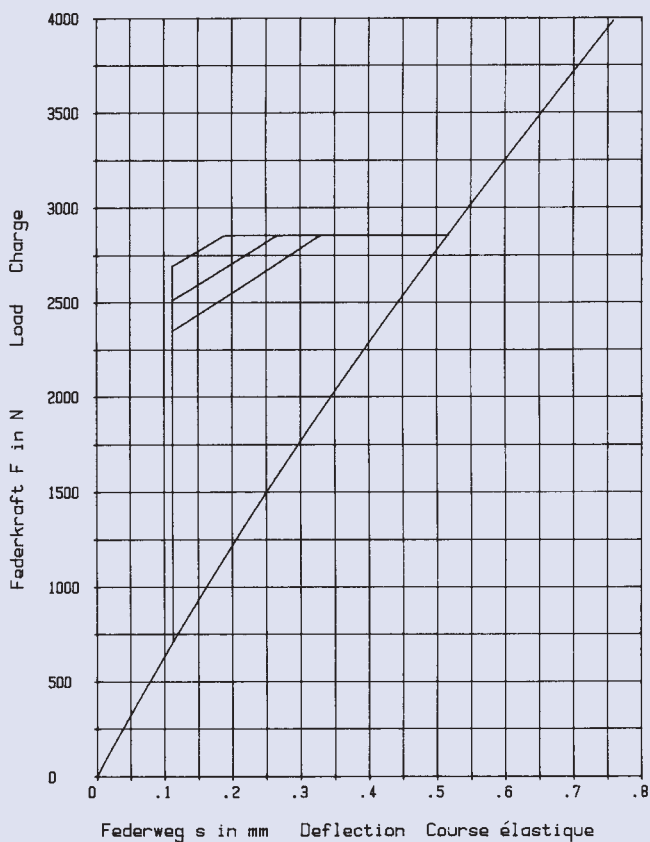

$h_0 = 0,75 \text{ mm}$        $D_e / D_i = 2,295$   
 $t = 1,5 \text{ mm}$        $D_e / t = 18,666$   
 $h_0 / t = 0,5$        $m = 5,872 \text{ g}$

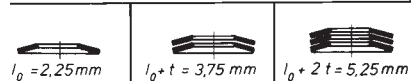

28 x 14,2 x 0,8

GR 1, DIN 2093 – C 28

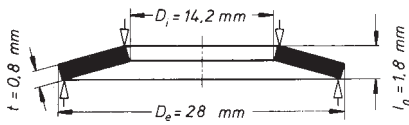

$h_0 = 1,0 \text{ mm}$        $D_e/D_i = 1,971$   
 $t = 0,8 \text{ mm}$        $D_e/t = 35$   
 $h_0/t = 1,25$        $m = 2,872 \text{ g}$

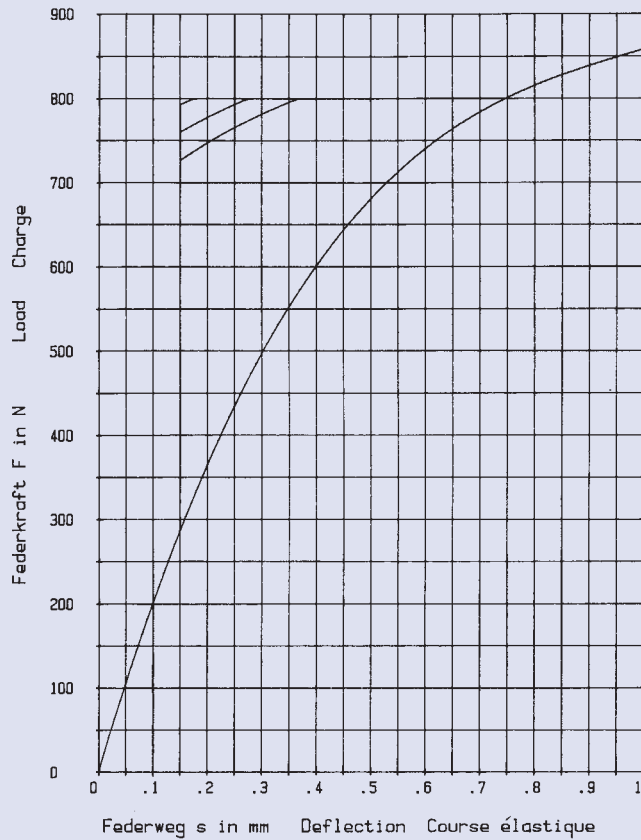
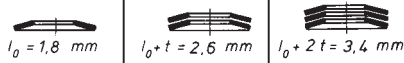

28 x 14,2 x 1,0

GR 1, DIN 2093 – B 28

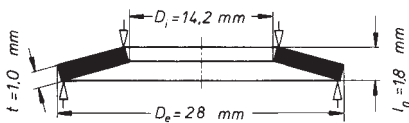

$h_0 = 0,8 \text{ mm}$        $D_e/D_i = 1,971$   
 $t = 1,0 \text{ mm}$        $D_e/t = 28$   
 $h_0/t = 0,8$        $m = 3,59 \text{ g}$

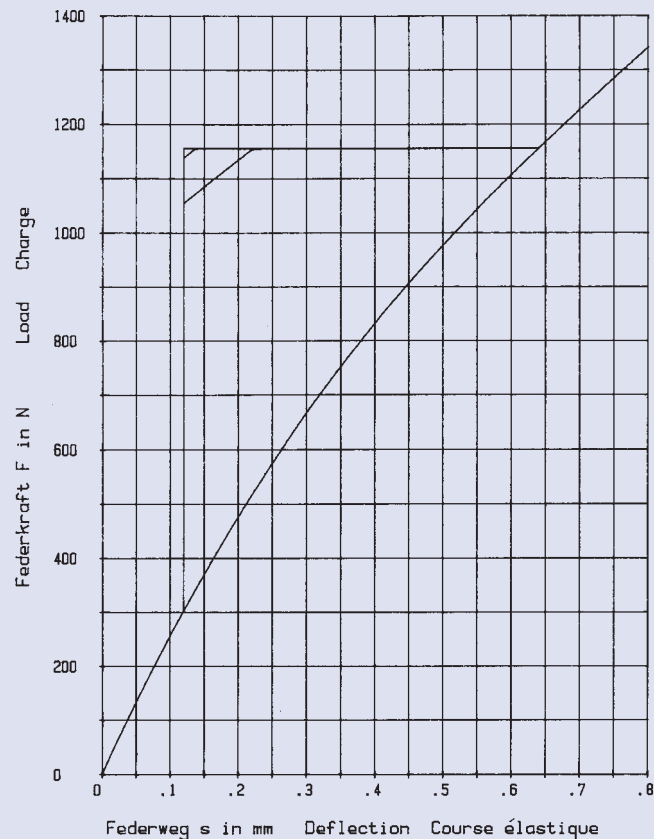
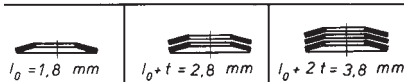

28 x 14,2 x 1,25

GR 2

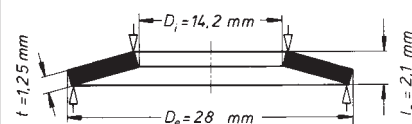
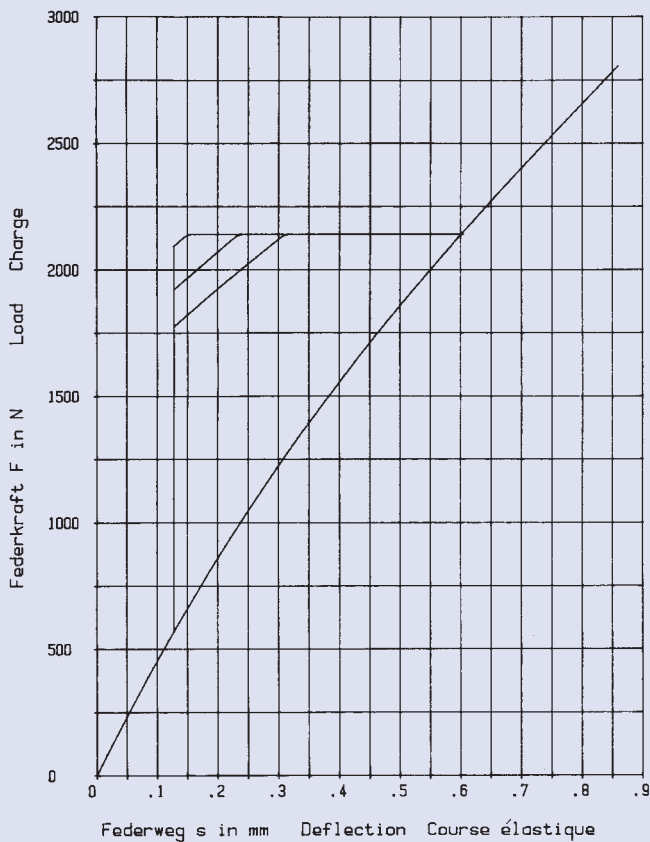

$h_0 = 0,85 \text{ mm}$        $D_e / D_i = 1,971$   
 $t = 1,25 \text{ mm}$        $D_e / t = 22,4$   
 $h_0 / t = 0,68$        $m = 4,486 \text{ g}$



28 x 14,2 x 1,5

GR 2, DIN 2093 – A 28

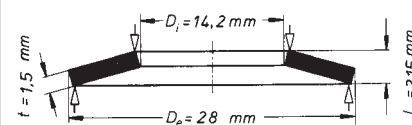
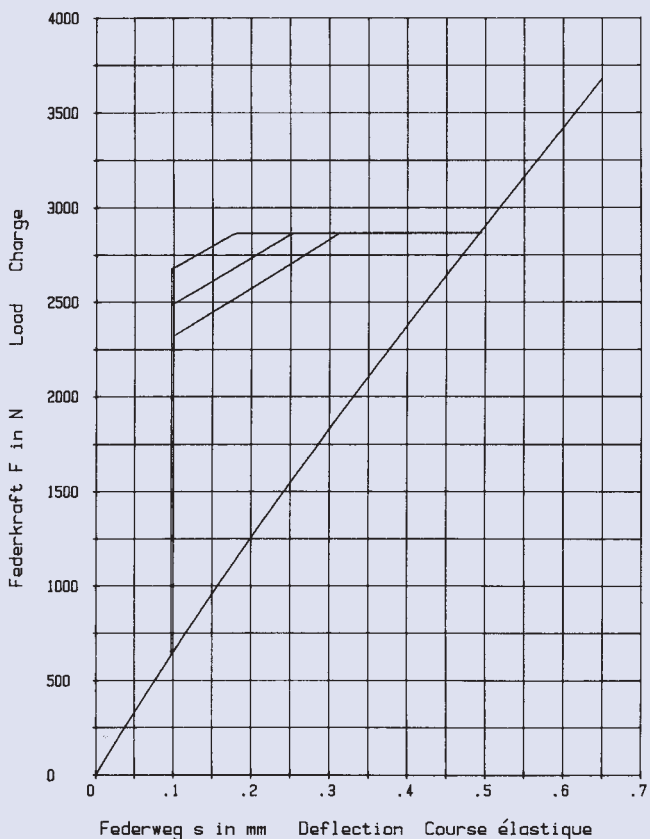

$h_0 = 0,65 \text{ mm}$        $D_e / D_i = 1,971$   
 $t = 1,5 \text{ mm}$        $D_e / t = 18,666$   
 $h_0 / t = 0,433$        $m = 5,386 \text{ g}$



31,5 x 16,3 x 0,8

GR 1, DIN 2093 – C 31,5

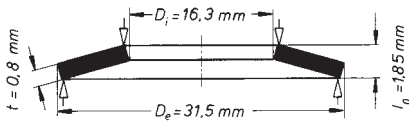

$h_0 = 1,05 \text{ mm}$        $D_e / D_i = 1,932$   
 $t = 0,8 \text{ mm}$        $D_e / t = 39,375$   
 $h_0 / t = 1,312$        $m = 3,583 \text{ g}$

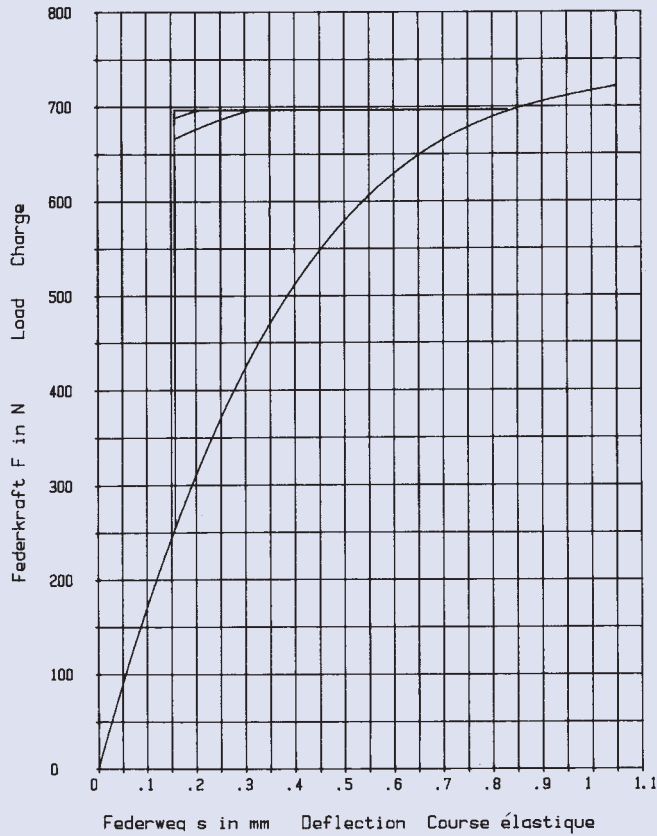
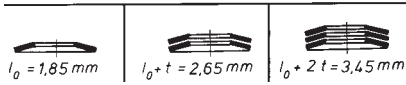

31,5 x 16,3 x 1,25

GR 2, DIN 2093 – B 31,5

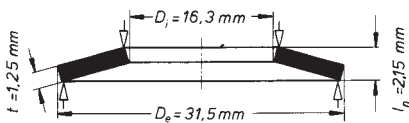

$h_0 = 0,9 \text{ mm}$        $D_e / D_i = 1,932$   
 $t = 1,25 \text{ mm}$        $D_e / t = 25,2$   
 $h_0 / t = 0,72$        $m = 5,599 \text{ g}$

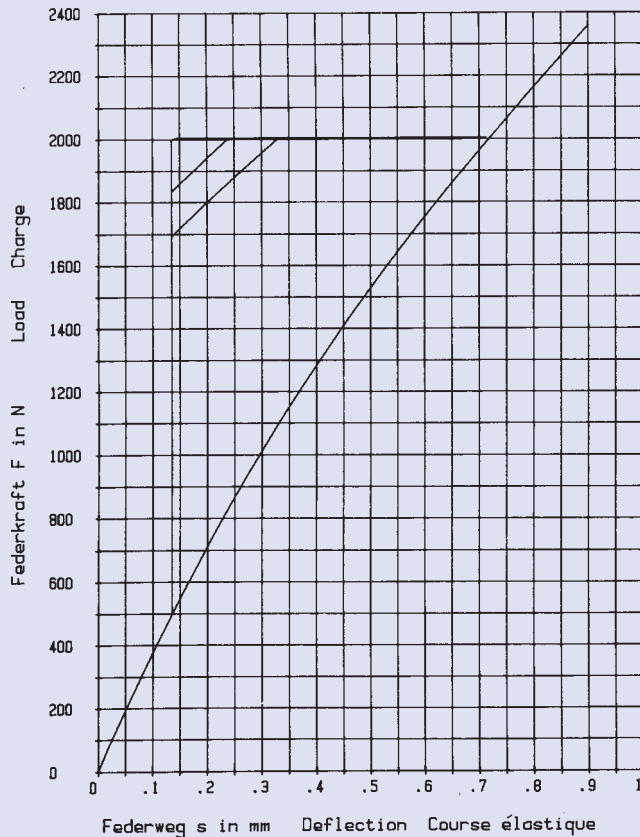
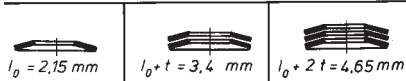



31,5 x 16,3 x 1,5

GR 2

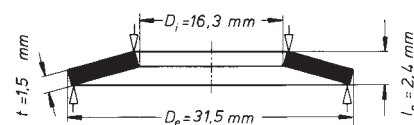
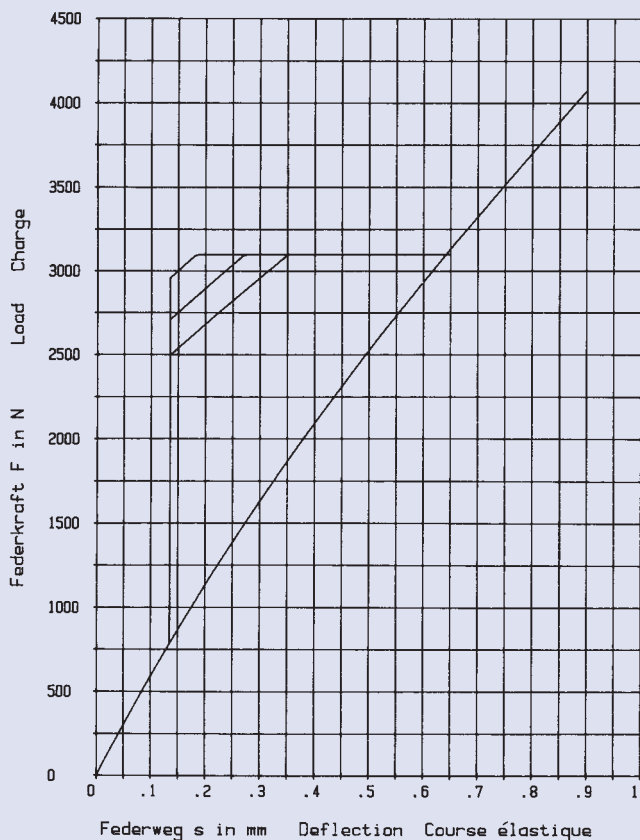

$h_0 = 0,9 \text{ mm}$        $D_e / D_i = 1,932$   
 $t = 1,5 \text{ mm}$        $D_e / t = 21$   
 $h_0 / t = 0,6$        $m = 6,717 \text{ g}$

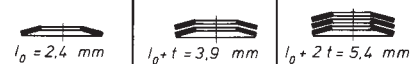

31,5 x 16,3 x 1,75

GR 2, DIN 2093 – A 31,5

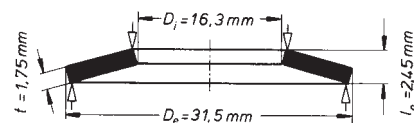
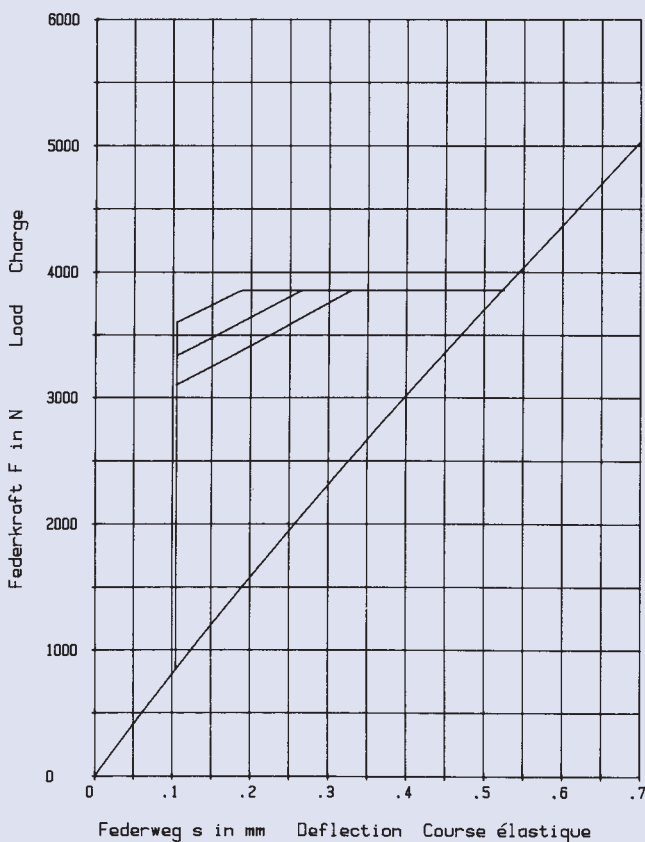

$h_0 = 0,7 \text{ mm}$        $D_e / D_i = 1,932$   
 $t = 1,75 \text{ mm}$        $D_e / t = 18$   
 $h_0 / t = 0,4$        $m = 7,839 \text{ g}$

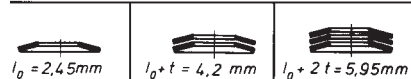

31,5 x 16,3 x 2,0

GR 2

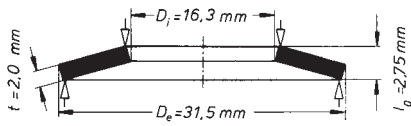

$h_0 = 0,75 \text{ mm}$        $D_e/D_i = 1,932$   
 $t = 2,0 \text{ mm}$        $D_e/t = 15,75$   
 $h_0/t = 0,375$        $m = 8,956 \text{ g}$

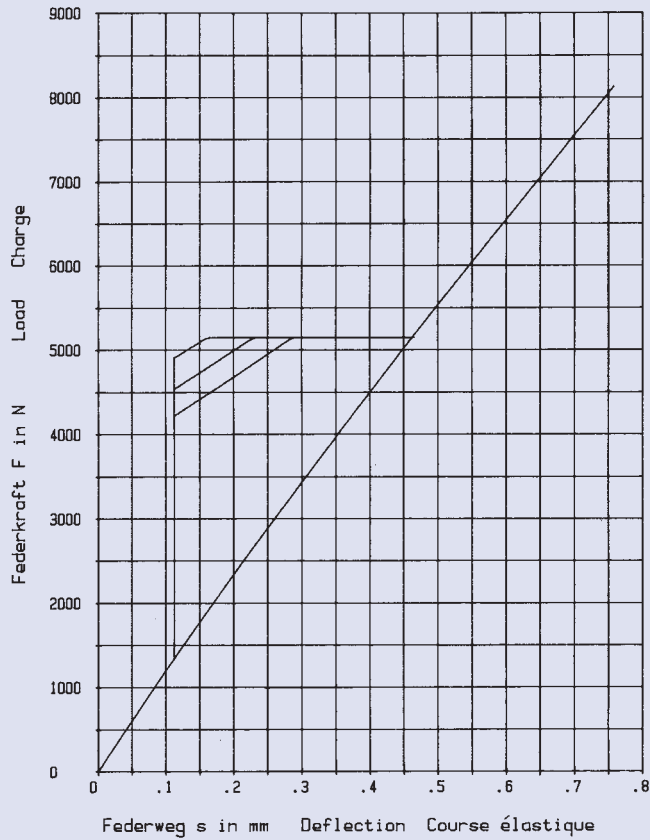

34 x 12,3 x 1,0

GR 2

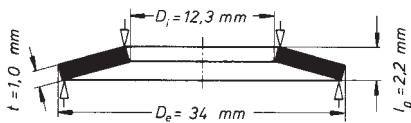

$h_0 = 1,2 \text{ mm}$        $D_e/D_i = 2,764$   
 $t = 1,0 \text{ mm}$        $D_e/t = 34$   
 $h_0/t = 1,2$        $m = 6,194 \text{ g}$

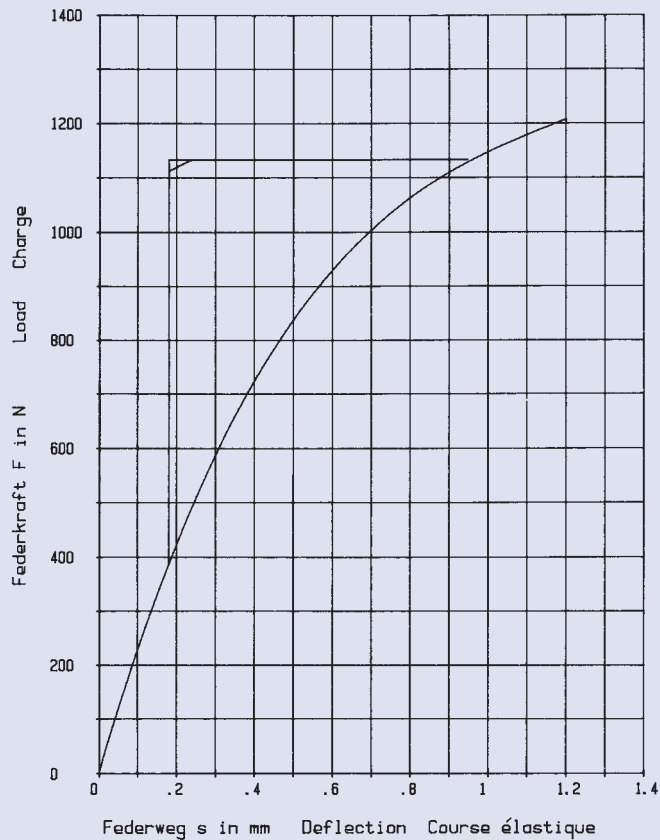
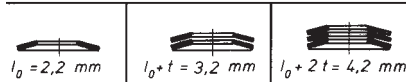

34 x 12,3 x 1,25

GR 2

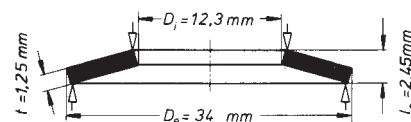
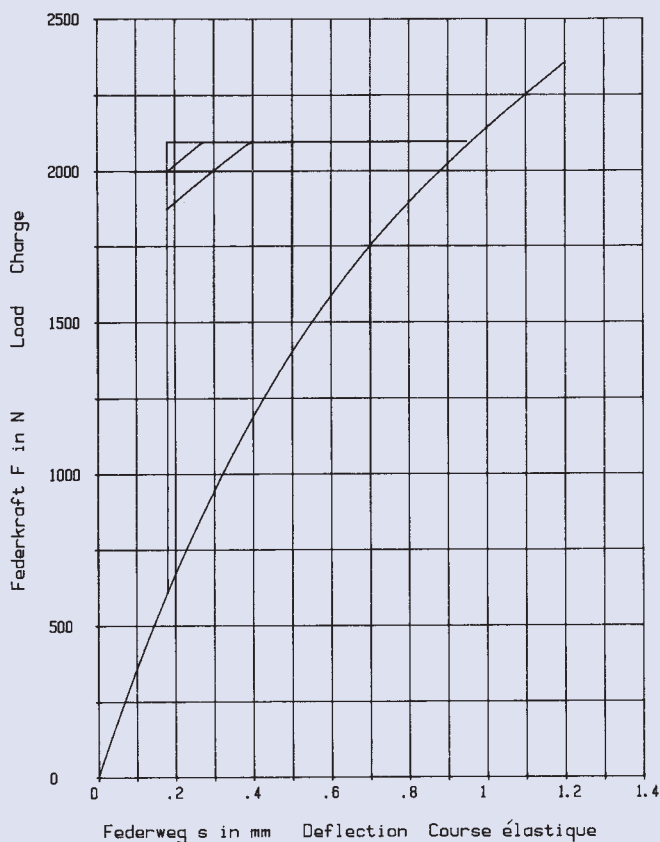

$h_0 = 1,2 \text{ mm}$        $D_e/D_i = 2,764$   
 $t = 1,25 \text{ mm}$        $D_e/t = 27,2$   
 $h_0/t = 0,96$        $m = 7,743 \text{ g}$

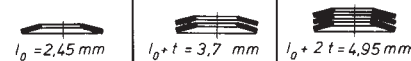

34 x 12,3 x 1,5

GR 2

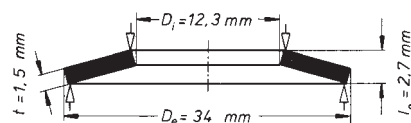
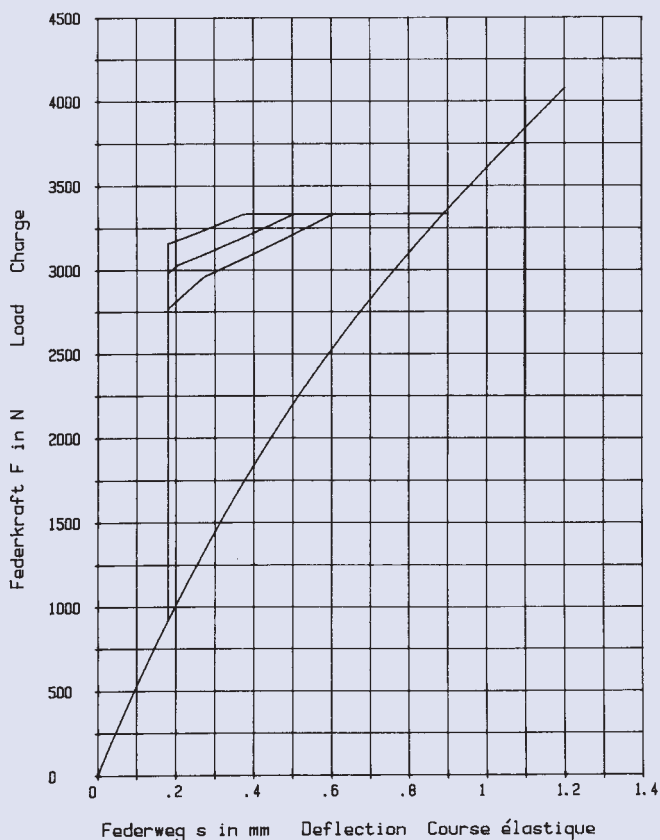

$h_0 = 1,2 \text{ mm}$        $D_e/D_i = 2,764$   
 $t = 1,5 \text{ mm}$        $D_e/t = 22,666$   
 $h_0/t = 0,8$        $m = 9,288 \text{ g}$

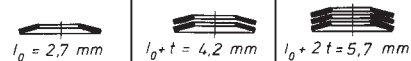

34 x 14,3 x 1,25

GR 2

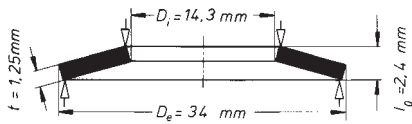

$h_0 = 1,15 \text{ mm}$        $D_e / D_i = 2,377$   
 $t = 1,25 \text{ mm}$        $D_e / t = 27,2$   
 $h_0 / t = 0,92$        $m = 7,33 \text{ g}$

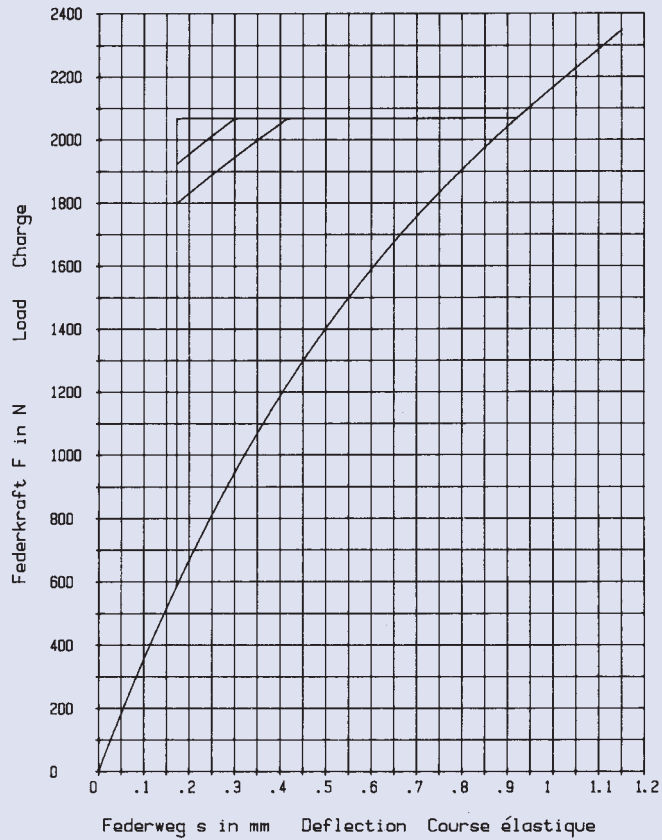
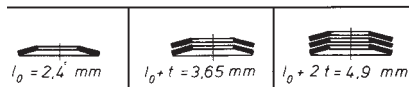

34 x 14,3 x 1,5

GR 2

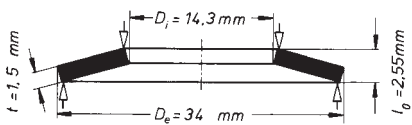

$h_0 = 1,05 \text{ mm}$        $D_e / D_i = 2,377$   
 $t = 1,5 \text{ mm}$        $D_e / t = 22,666$   
 $h_0 / t = 0,7$        $m = 8,799 \text{ g}$

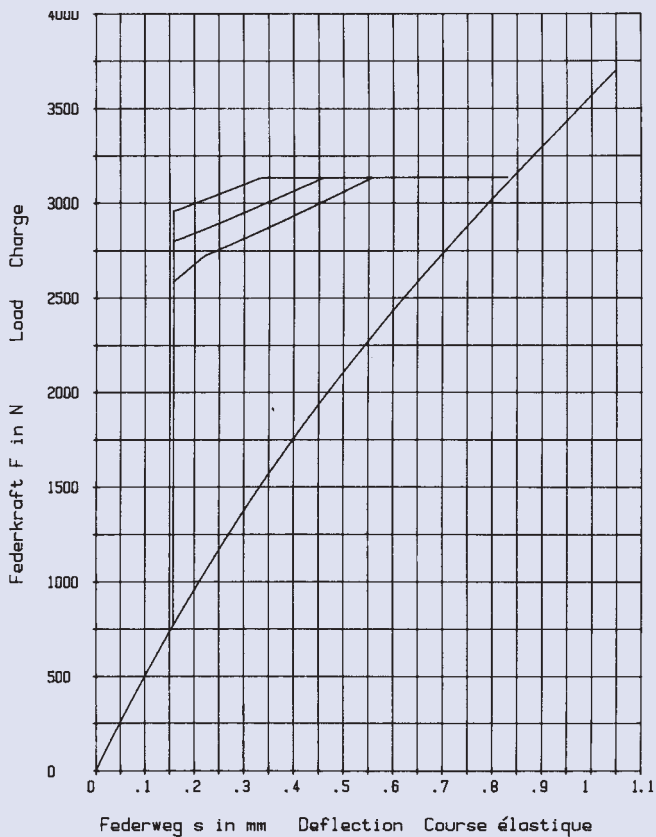
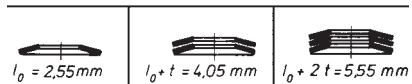

34 x 16,3 x 1,5

GR 2

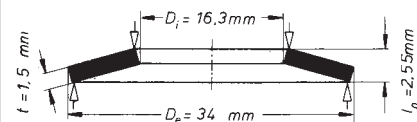
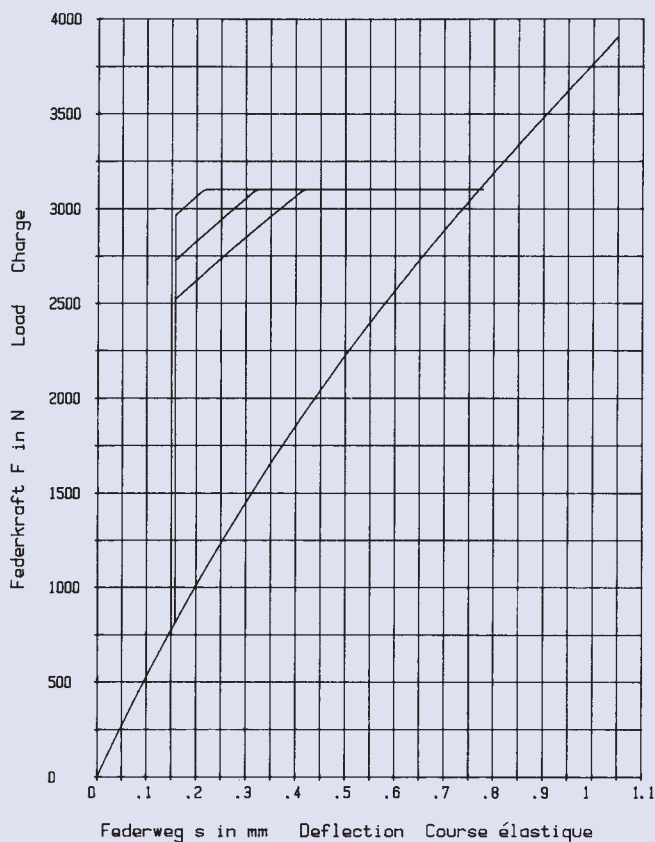

$h_0 = 1,05 \text{ mm}$        $D_e / D_i = 2,085$   
 $t = 1,5 \text{ mm}$        $D_e / t = 22,666$   
 $h_0 / t = 0,7$        $m = 8,233 \text{ g}$

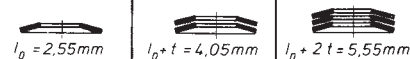

34 x 16,3 x 2,0

GR 2

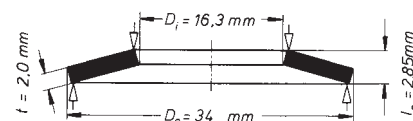
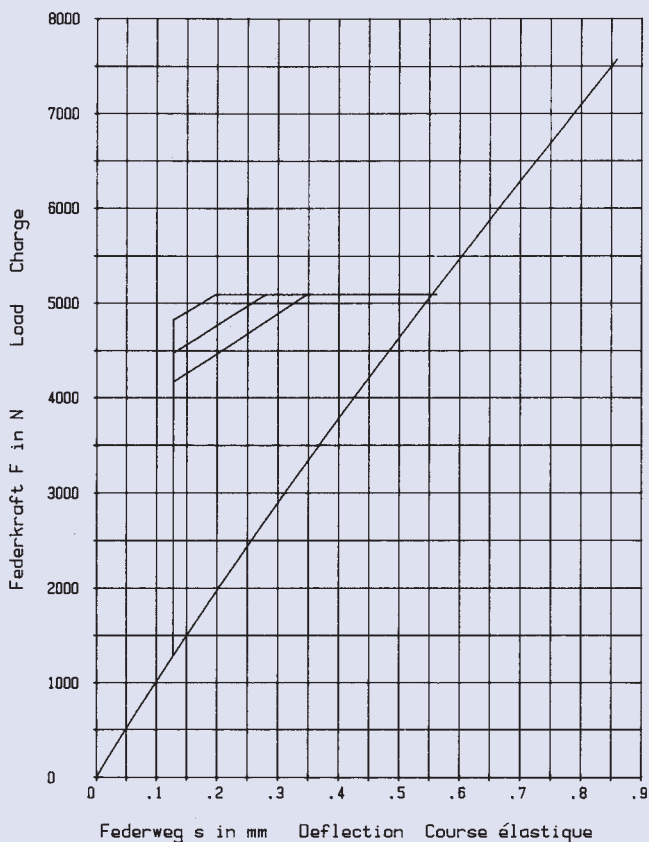

$h_0 = 0,85 \text{ mm}$        $D_e / D_i = 2,085$   
 $t = 2,0 \text{ mm}$        $D_e / t = 17$   
 $h_0 / t = 0,425$        $m = 10,978 \text{ g}$

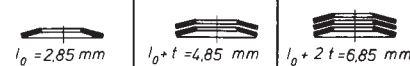

35,5 x 18,3 x 0,9

GR 1, DIN 2093 – C 35,5

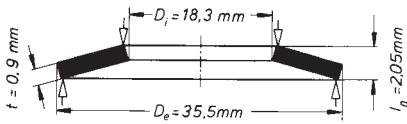

$h_0 = 1,15 \text{ mm}$        $D_e / D_i = 1,939$   
 $t = 0,9 \text{ mm}$        $D_e / t = 39,444$   
 $h_0 / t = 1,277$        $m = 5,134 \text{ g}$

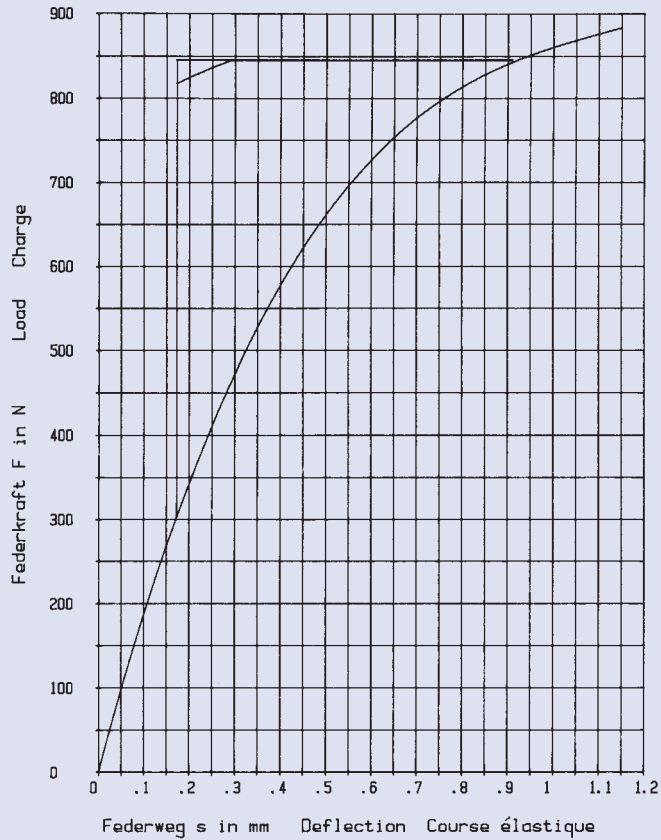
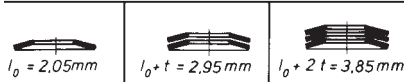

35,5 x 18,3 x 1,25

GR 2, DIN 2093 – B 35,5

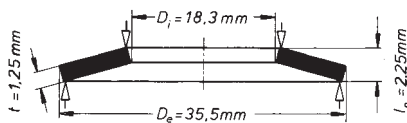

$h_0 = 1,0 \text{ mm}$        $D_e / D_i = 1,939$   
 $t = 1,25 \text{ mm}$        $D_e / t = 28,4$   
 $h_0 / t = 0,8$        $m = 7,131 \text{ g}$

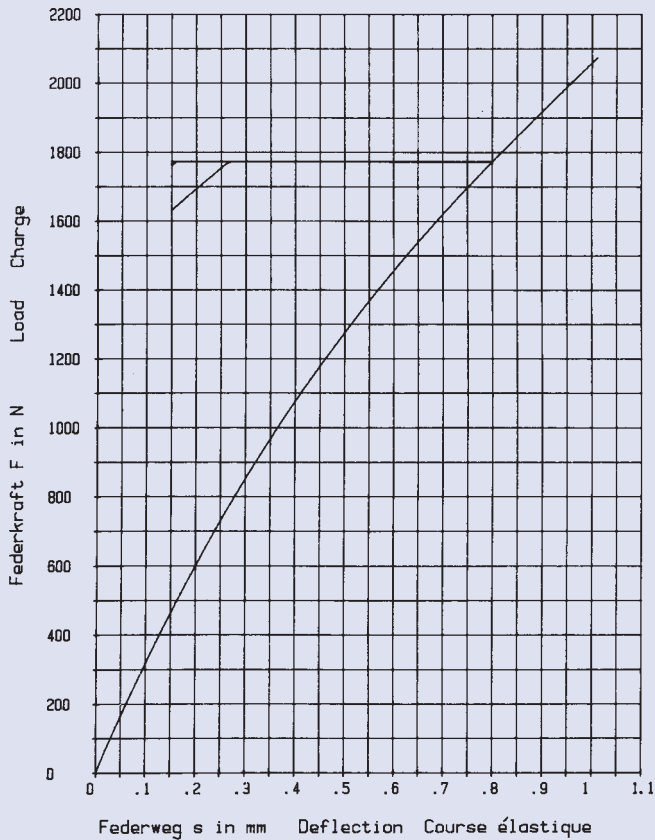
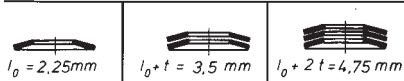

35,5 x 18,3 x 2,0

GR 2, DIN 2093 – A 35,5

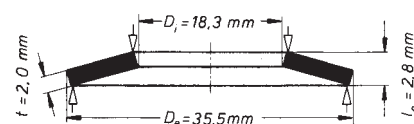
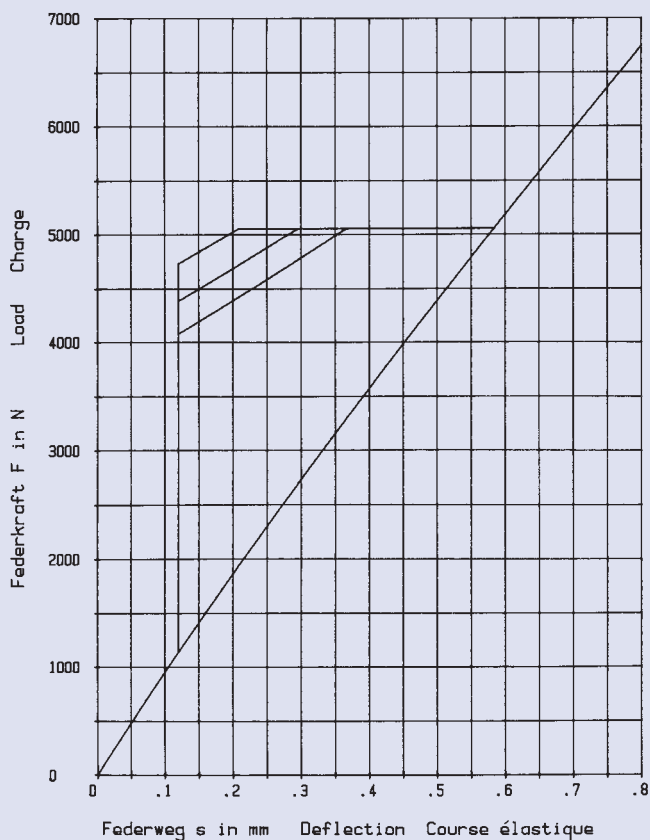

$h_0 = 0,8 \text{ mm}$        $D_e/D_i = 1,939$   
 $t = 2,0 \text{ mm}$        $D_e/t = 17,75$   
 $h_0/t = 0,4$        $m = 11,41 \text{ g}$

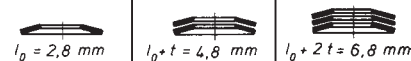

40 x 14,3 x 1,25

GR 2

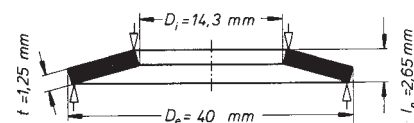
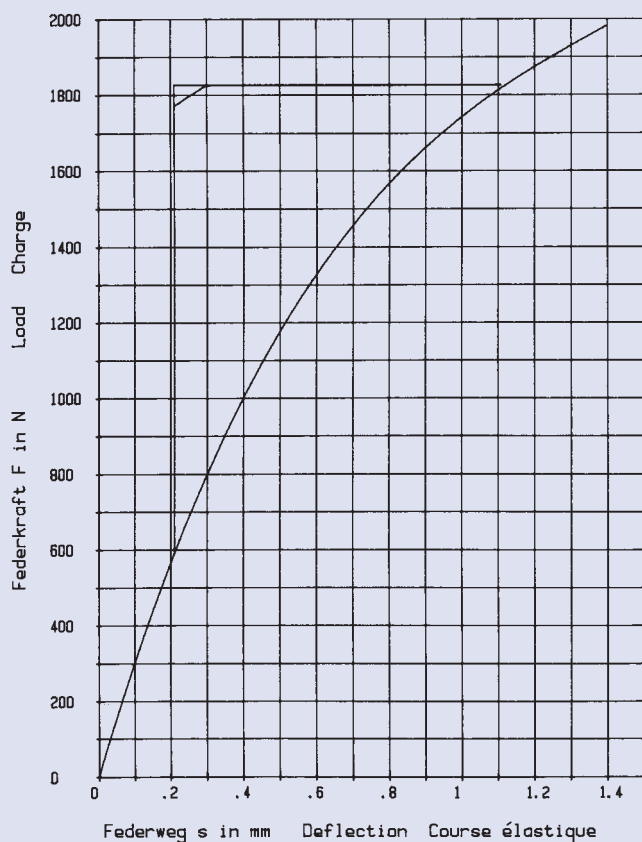

$h_0 = 1,4 \text{ mm}$        $D_e/D_i = 2,797$   
 $t = 1,25 \text{ mm}$        $D_e/t = 32$   
 $h_0/t = 1,12$        $m = 10,755 \text{ g}$

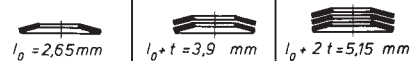

40 x 14,3 x 1,5

GR 2

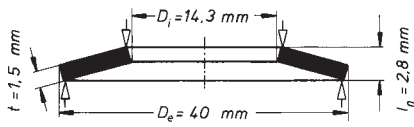

$h_0 = 1,3 \text{ mm}$        $D_e / D_i = 2,797$   
 $t = 1,5 \text{ mm}$        $D_e / t = 26,666$   
 $h_0 / t = 0,866$        $m = 12,905 \text{ g}$

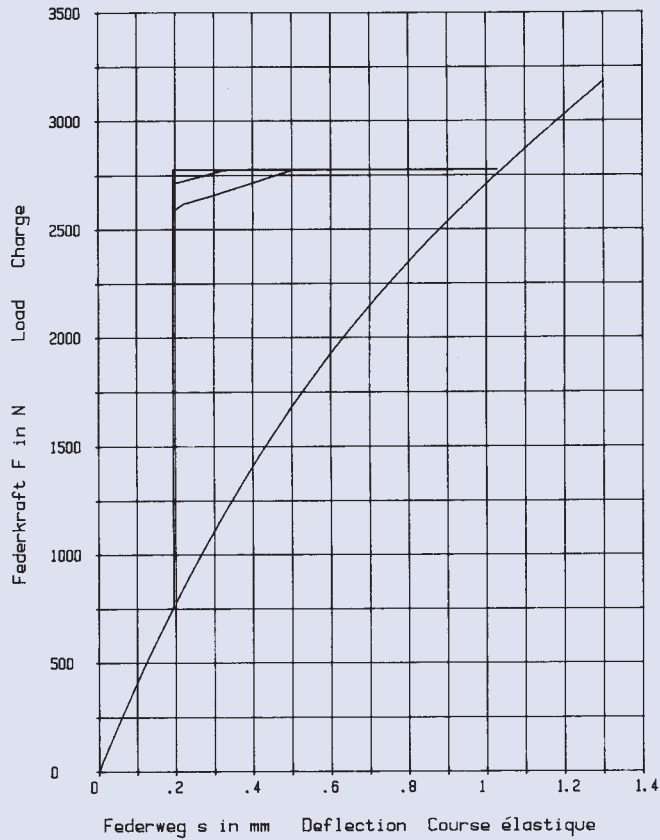
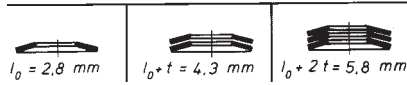

40 x 14,3 x 1,75

GR 2

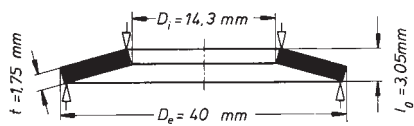

$h_0 = 1,3 \text{ mm}$        $D_e / D_i = 2,797$   
 $t = 1,75 \text{ mm}$        $D_e / t = 22,857$   
 $h_0 / t = 0,742$        $m = 15,056 \text{ g}$

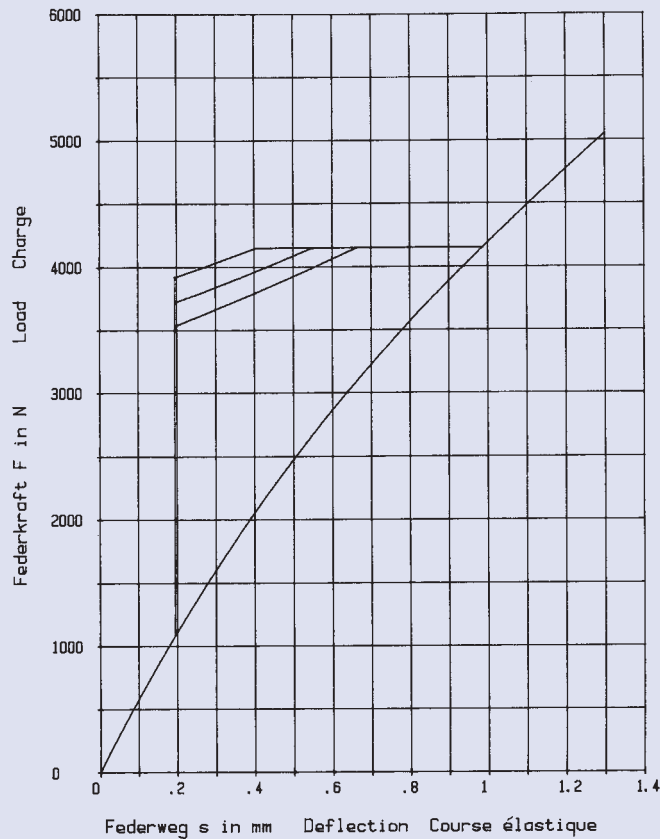
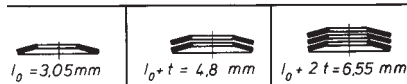



40 x 14,3 x 2,0

GR 2

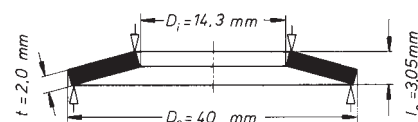
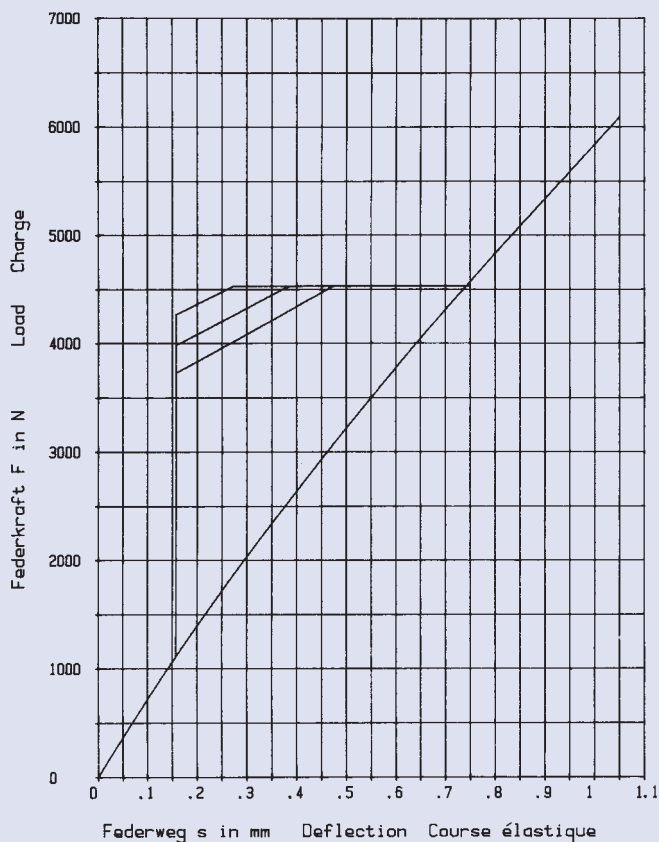

$h_0 = 1,05 \text{ mm}$        $D_e / D_i = 2,797$   
 $t = 2,0 \text{ mm}$        $D_e / t = 20$   
 $h_0 / t = 0,525$        $m = 17,207 \text{ g}$



40 x 16,3 x 1,5

GR 2

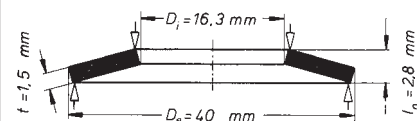
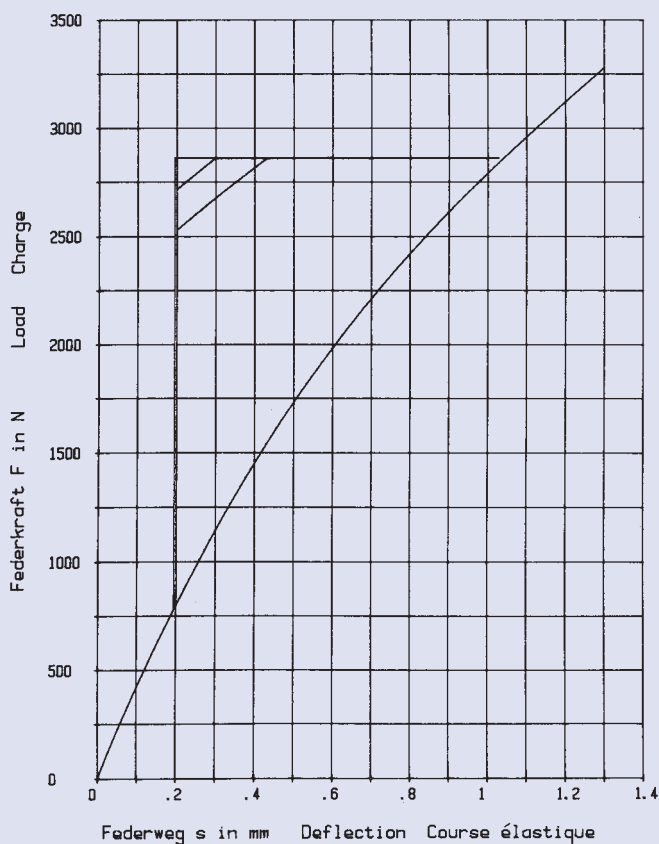

$h_0 = 1,3 \text{ mm}$        $D_e / D_i = 2,453$   
 $t = 1,5 \text{ mm}$        $D_e / t = 26,666$   
 $h_0 / t = 0,866$        $m = 12,339 \text{ g}$

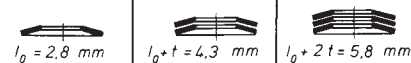

40 x 16,3 x 1,75

GR 2

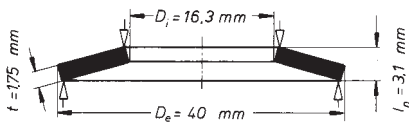

$h_0 = 1,35 \text{ mm}$        $D_e/D_i = 2,453$   
 $t = 1,75 \text{ mm}$        $D_e/t = 22,857$   
 $h_0/t = 0,771$        $m = 14,396 \text{ g}$

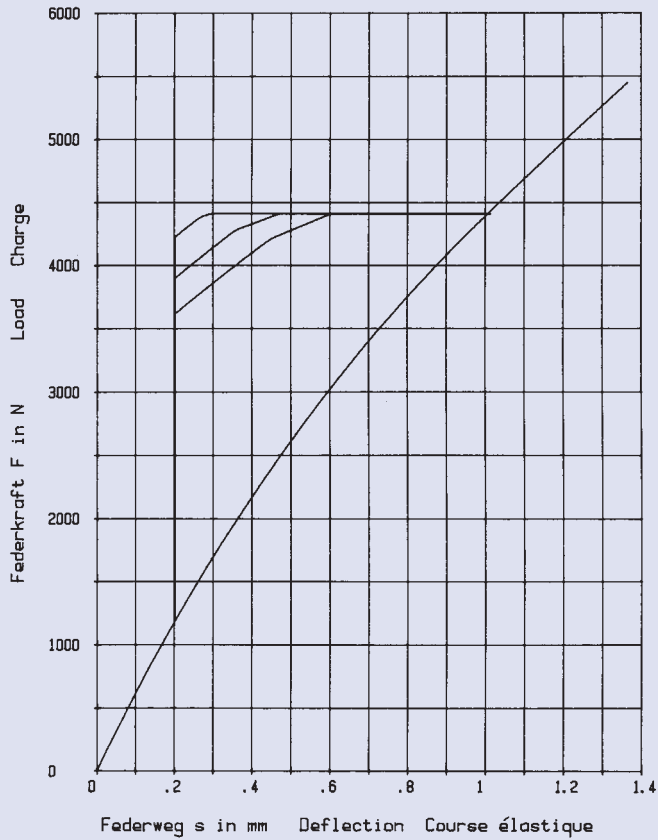
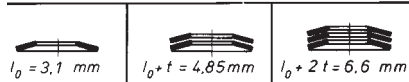

40 x 16,3 x 2,0

GR 2

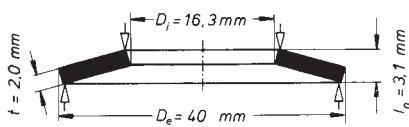

$h_0 = 1,1 \text{ mm}$        $D_e/D_i = 2,453$   
 $t = 2,0 \text{ mm}$        $D_e/t = 20$   
 $h_0/t = 0,55$        $m = 16,499 \text{ g}$

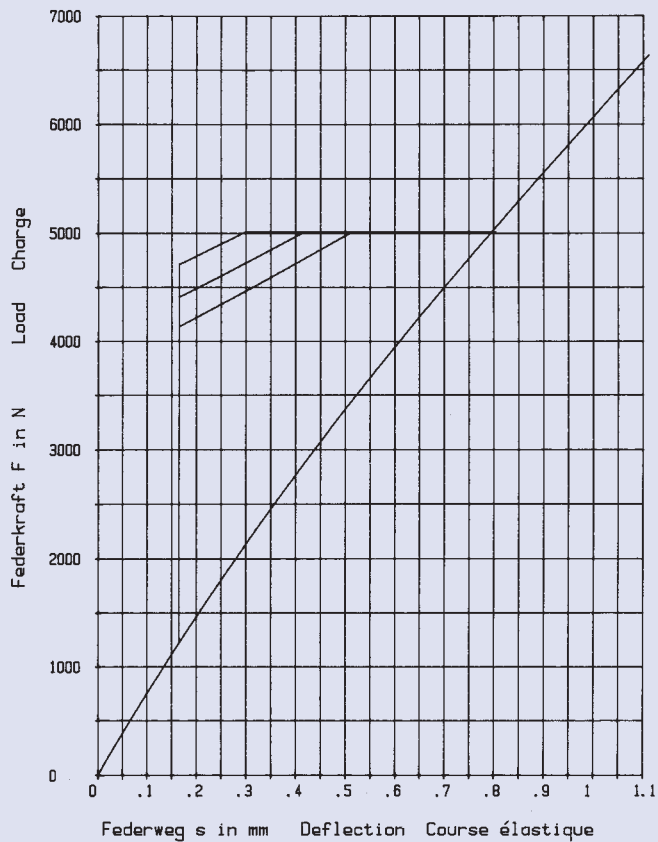
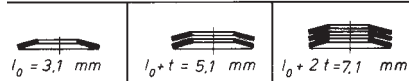

40 x 18,3 x 2,0

GR 2

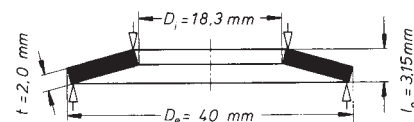
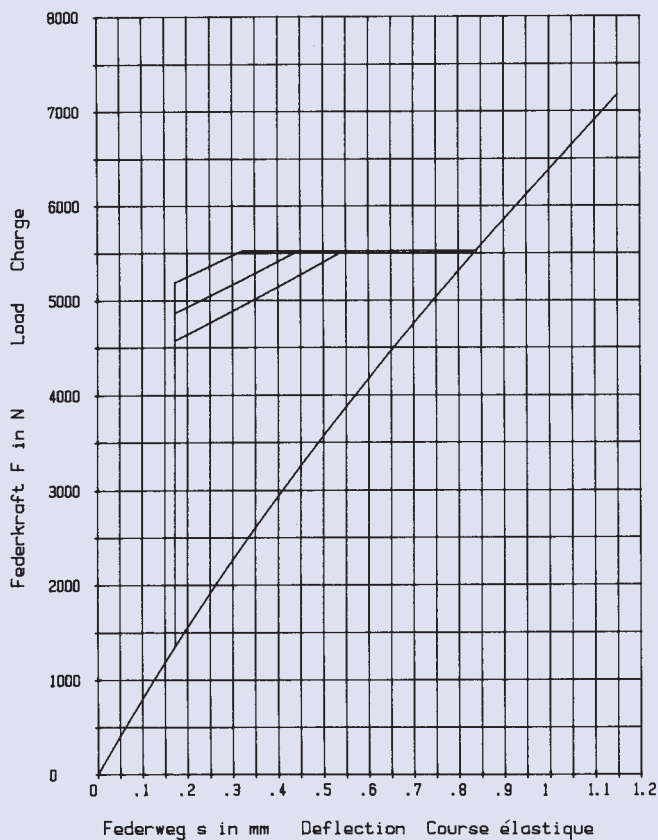

$h_0 = 1,15 \text{ mm}$        $D_e/D_1 = 2,185$   
 $t = 2,0 \text{ mm}$        $D_e/t = 20$   
 $h_0/t = 0,575$        $m = 15,599 \text{ g}$



40 x 20,4 x 1,0

GR 1, DIN 2093 – C 40

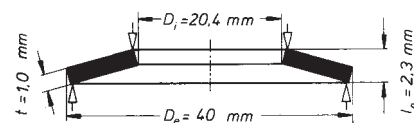
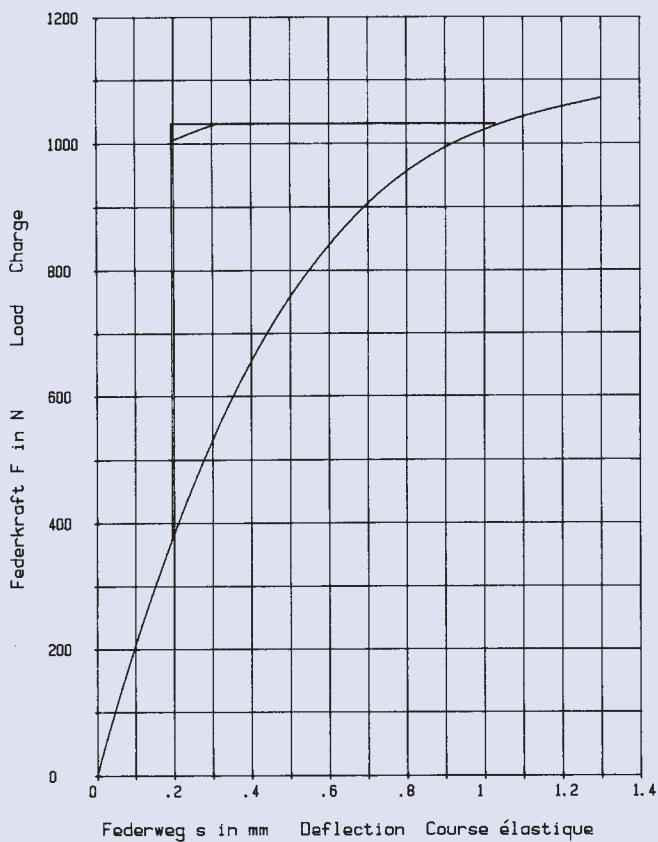

40 x 20,4 x 1,5

GR 2, DIN 2093 – B 40

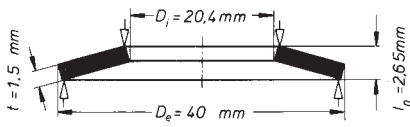

$h_0 = 1,15 \text{ mm}$        $D_e / D_i = 1,96$   
 $t = 1,5 \text{ mm}$        $D_e / t = 26,666$   
 $h_0 / t = 0,766$        $m = 10,948 \text{ g}$

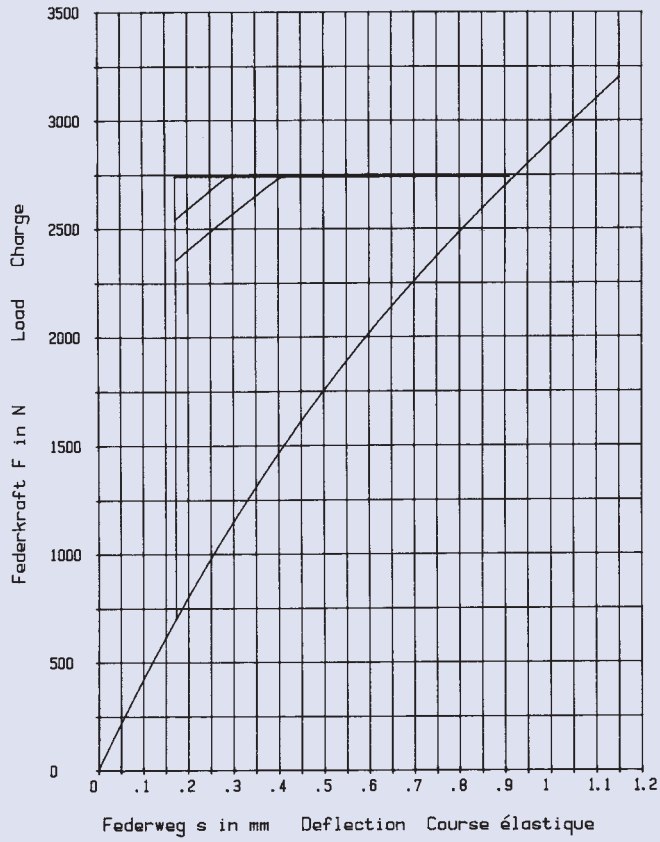
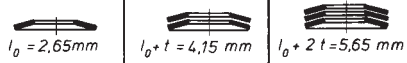

40 x 20,4 x 2,0

GR 2

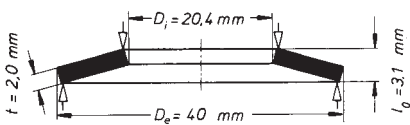

$h_0 = 1,1 \text{ mm}$        $D_e / D_i = 1,96$   
 $t = 2,0 \text{ mm}$        $D_e / t = 20$   
 $h_0 / t = 0,55$        $m = 14,597 \text{ g}$

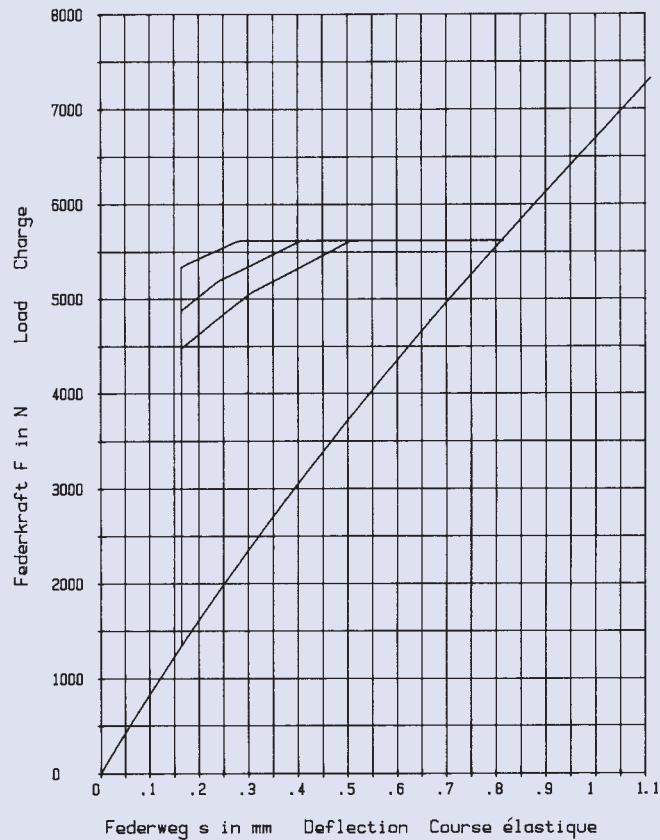
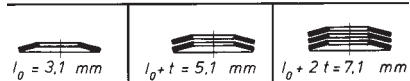

40 x 20,4 x 2,25

GR 2, DIN 2093 – A 40

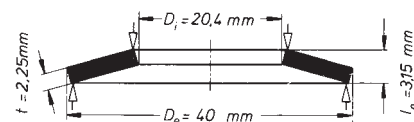
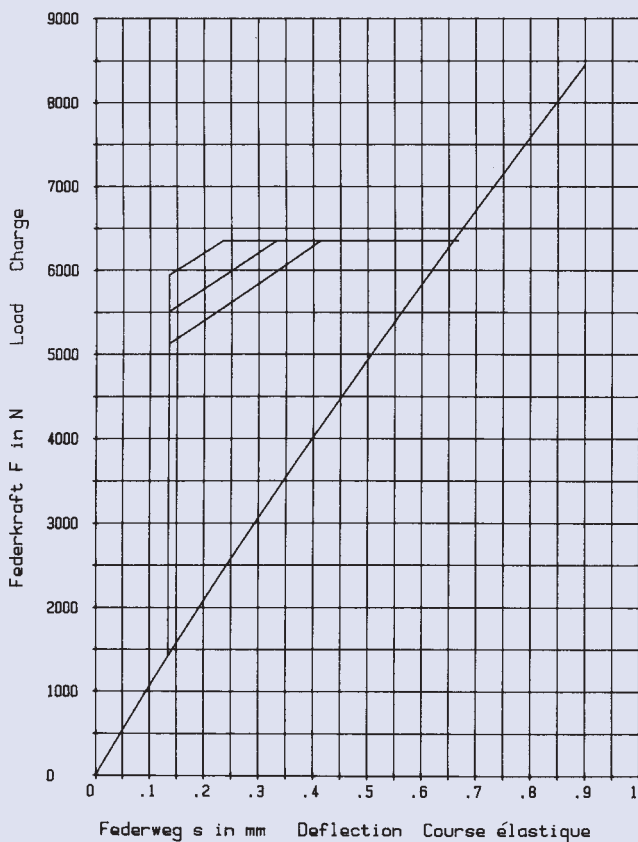

$h_0 = 0,9 \text{ mm}$        $D_e/D_i = 1,96$   
 $t = 2,25 \text{ mm}$        $D_e/t = 17,777$   
 $h_0/t = 0,4$        $m = 16,422 \text{ g}$

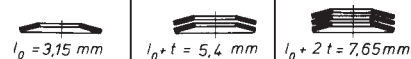

40 x 20,4 x 2,5

GR 2

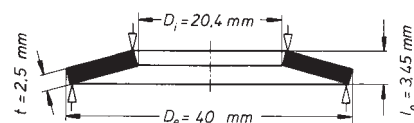
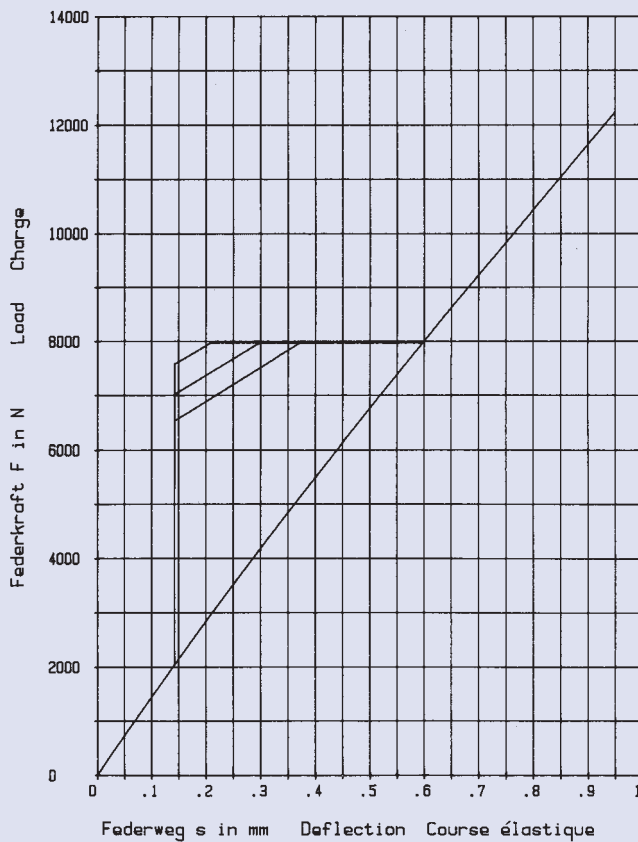

$h_0 = 0,95 \text{ mm}$        $D_e/D_i = 1,96$   
 $t = 2,5 \text{ mm}$        $D_e/t = 16$   
 $h_0/t = 0,38$        $m = 18,246 \text{ g}$



45 x 22,4 x 1,25

GR 2, DIN 2093 – C 45

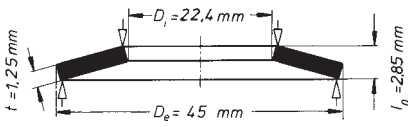

$h_0 = 1,6 \text{ mm}$        $D_e / D_i = 2,008$   
 $t = 1,25 \text{ mm}$        $D_e / t = 36$   
 $h_0 / t = 1,28$        $m = 11,739 \text{ g}$

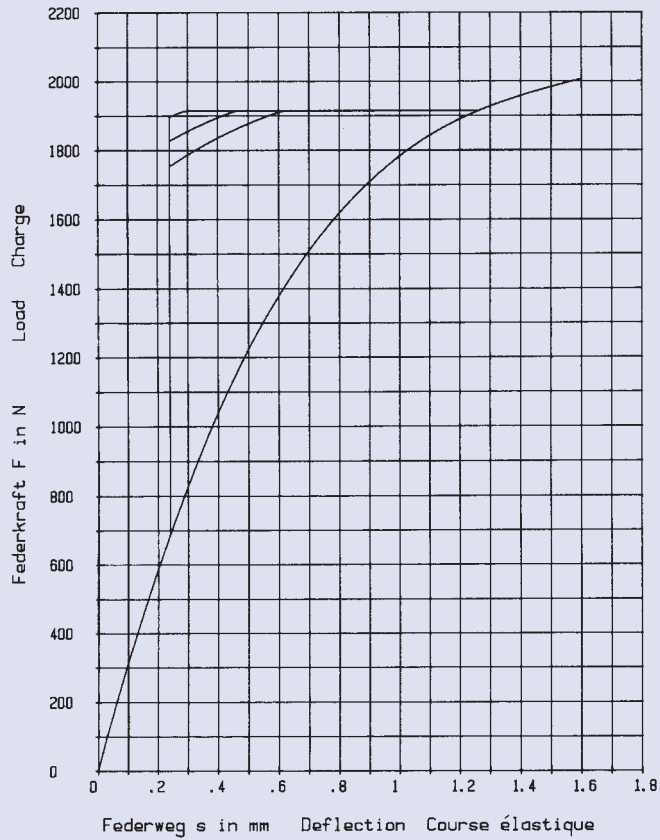
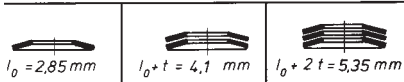

45 x 22,4 x 1,75

GR 2, DIN 2093 – B 45

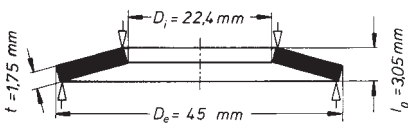

$h_0 = 1,3 \text{ mm}$        $D_e / D_i = 2,008$   
 $t = 1,75 \text{ mm}$        $D_e / t = 25,714$   
 $h_0 / t = 0,742$        $m = 16,434 \text{ g}$

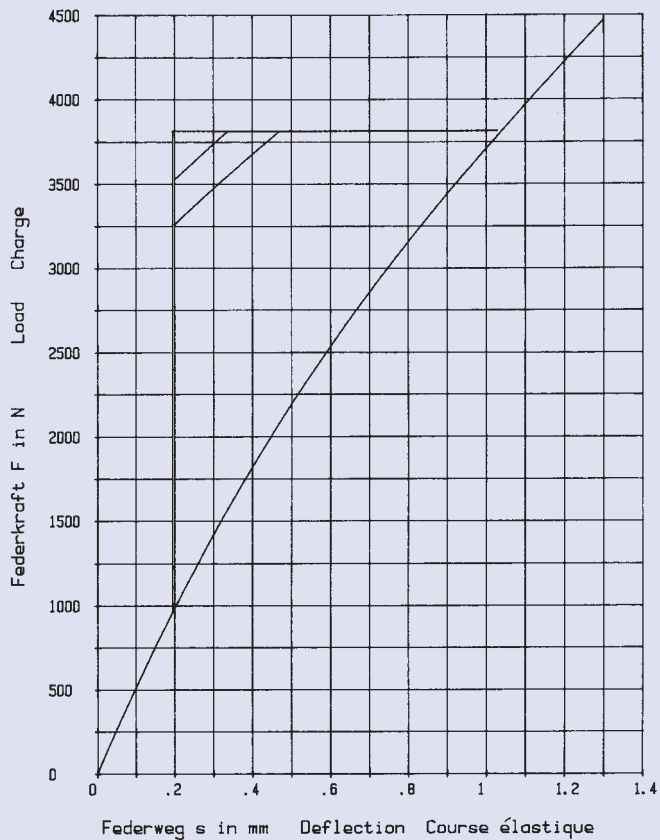
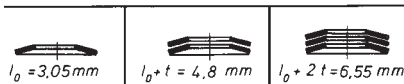

45 x 22,4 x 2,5

GR 2, DIN 2093 – A 45

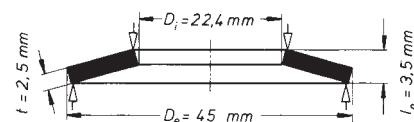

$h_0 = 1,0 \text{ mm}$        $D_e/D_i = 2,008$   
 $t = 2,5 \text{ mm}$        $D_e/t = 18$   
 $h_0/t = 0,4$        $m = 23,478 \text{ g}$

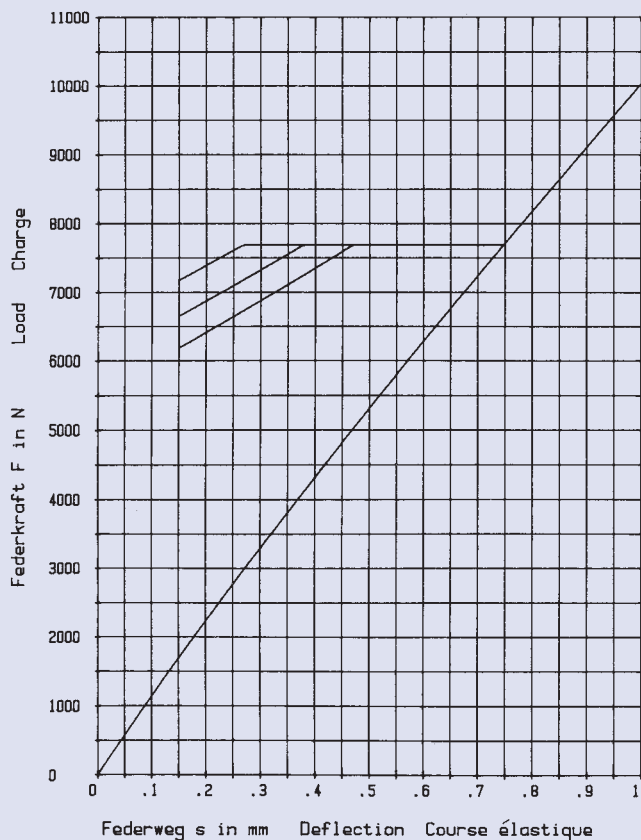

48 x 16,3 x 1,5

GR 2

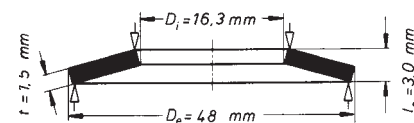

$h_0 = 1,5 \text{ mm}$        $D_e/D_i = 2,944$   
 $t = 1,5 \text{ mm}$        $D_e/t = 32$   
 $h_0/t = 1,0$        $m = 18,85 \text{ g}$

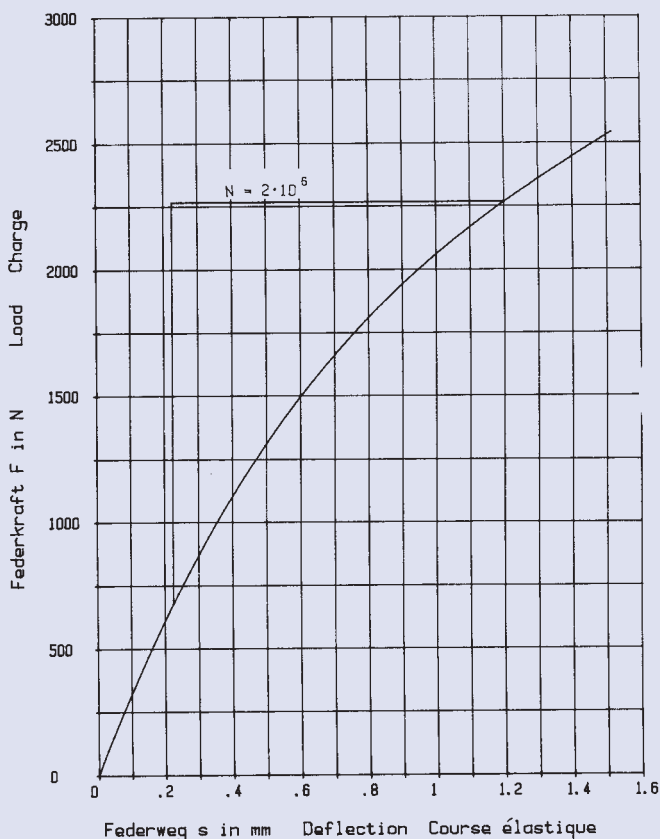
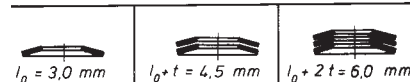

50 x 18,4 x 1,25

GR 2

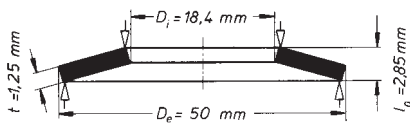

$h_0 = 1,6 \text{ mm}$        $D_e/D_i = 2,717$   
 $t = 1,25 \text{ mm}$        $D_e/t = 40$   
 $h_0/t = 1,28$        $m = 16,657 \text{ g}$

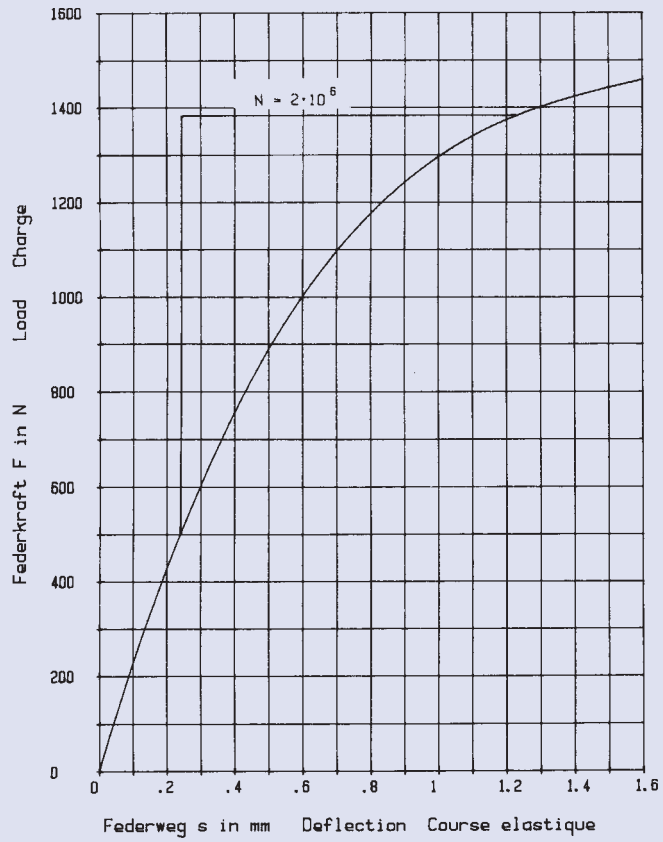
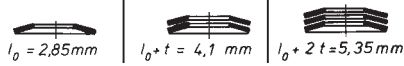

50 x 18,4 x 1,5

GR 2

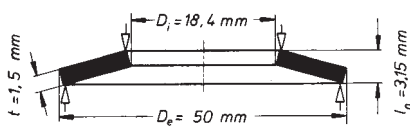

$h_0 = 1,65 \text{ mm}$        $D_e/D_i = 2,717$   
 $t = 1,5 \text{ mm}$        $D_e/t = 33,333$   
 $h_0/t = 1,1$        $m = 19,988 \text{ g}$

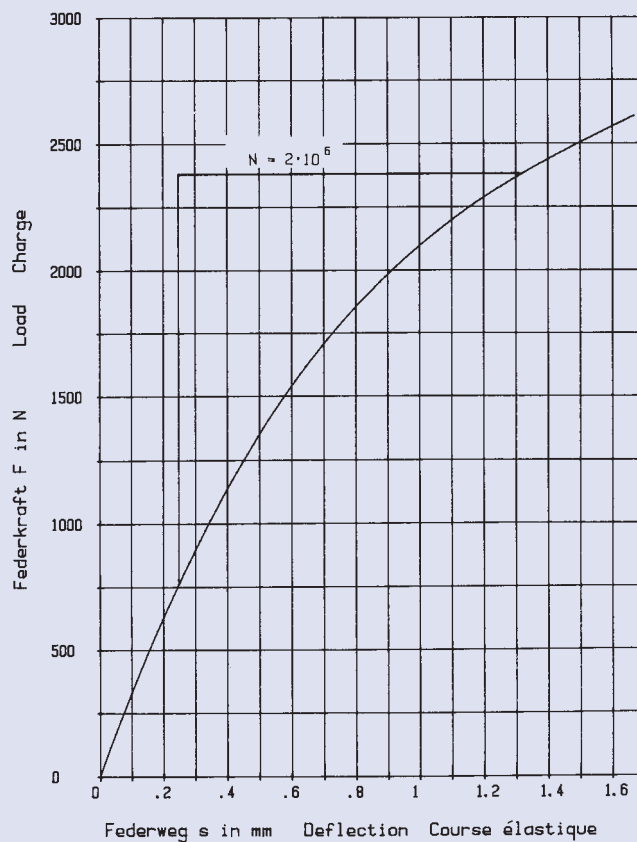
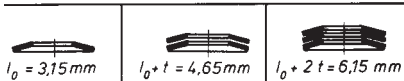



50 x 18,4 x 2,0

GR 2

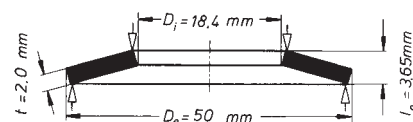
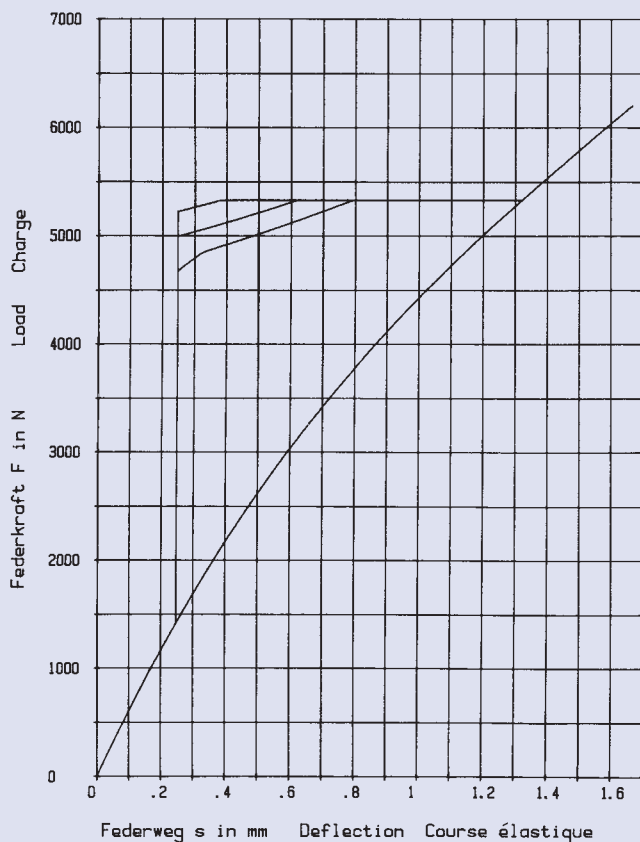

$h_0 = 1,65 \text{ mm}$        $D_e/D_i = 2,717$   
 $t = 2,0 \text{ mm}$        $D_e/t = 25$   
 $h_0/t = 0,825$        $m = 26,651 \text{ g}$



50 x 18,4 x 2,5

GR 2

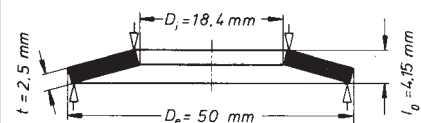
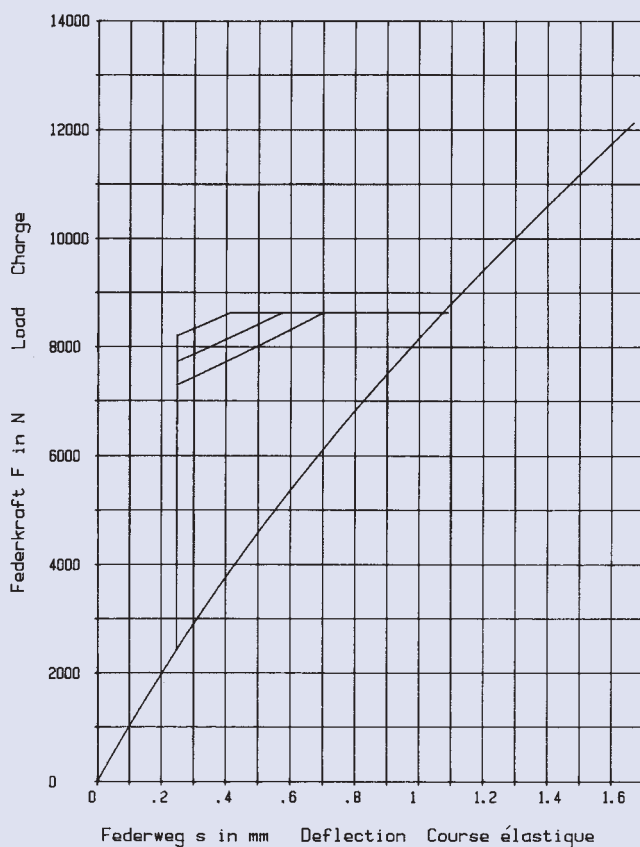

$h_0 = 1,65 \text{ mm}$        $D_e/D_i = 2,717$   
 $t = 2,5 \text{ mm}$        $D_e/t = 20$   
 $h_0/t = 0,66$        $m = 33,314 \text{ g}$

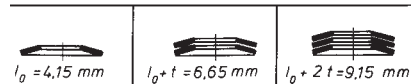

50 x 18,4 x 3,0

GR 2

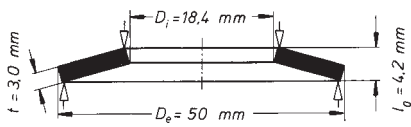

$h_0 = 1,2 \text{ mm}$        $D_e/D_i = 2,717$   
 $t = 3,0 \text{ mm}$        $D_e/t = 16,666$   
 $h_0/t = 0,4$        $m = 39,977 \text{ g}$

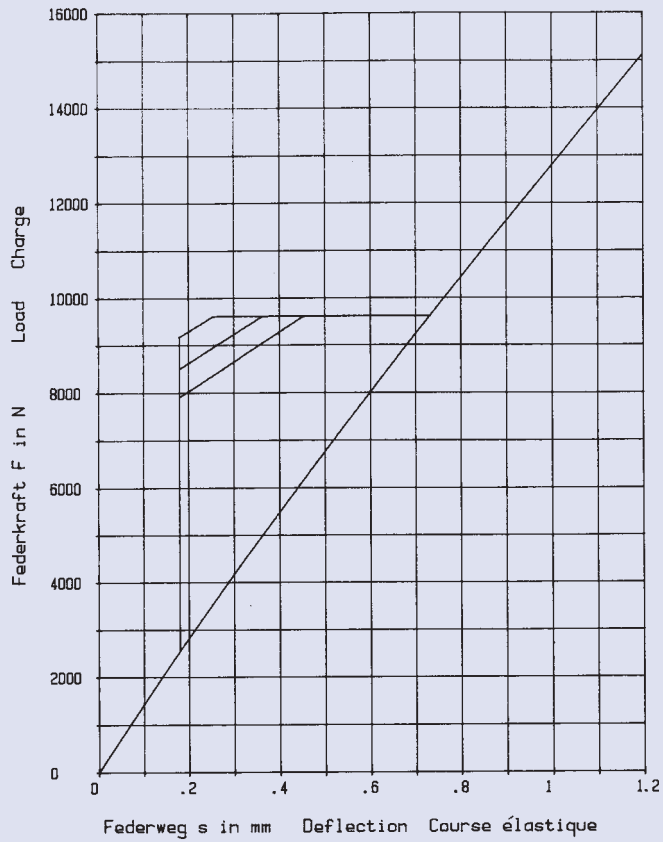
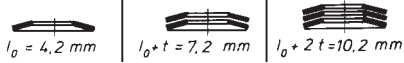

50 x 20,4 x 2,0

GR 2

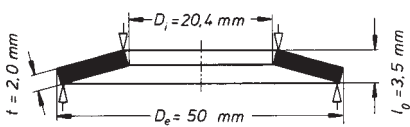

$h_0 = 1,5 \text{ mm}$        $D_e/D_i = 2,45$   
 $t = 2,0 \text{ mm}$        $D_e/t = 25$   
 $h_0/t = 0,75$        $m = 25,695 \text{ g}$

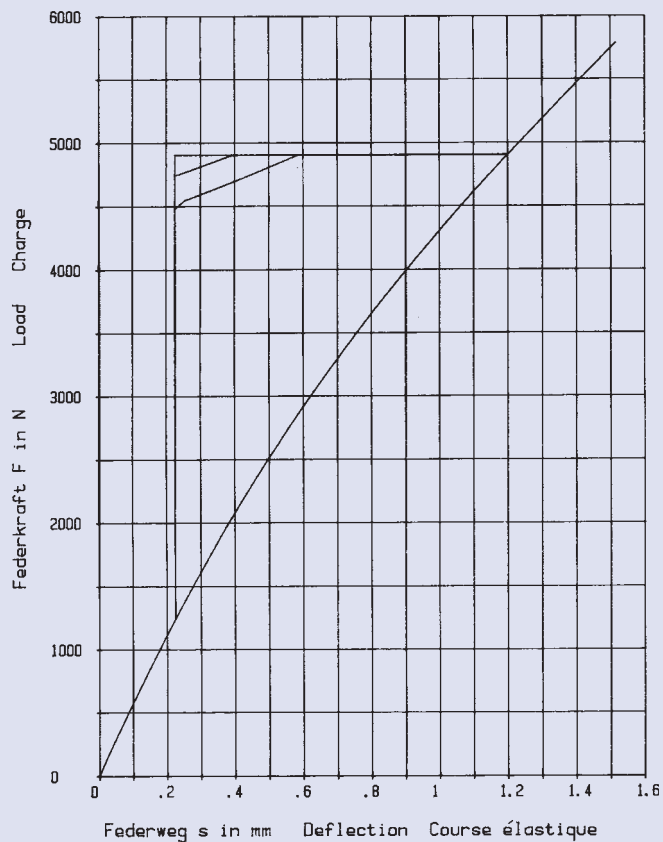
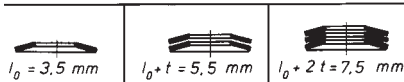

50 x 20,4 x 2,5

GR 2

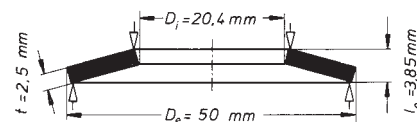
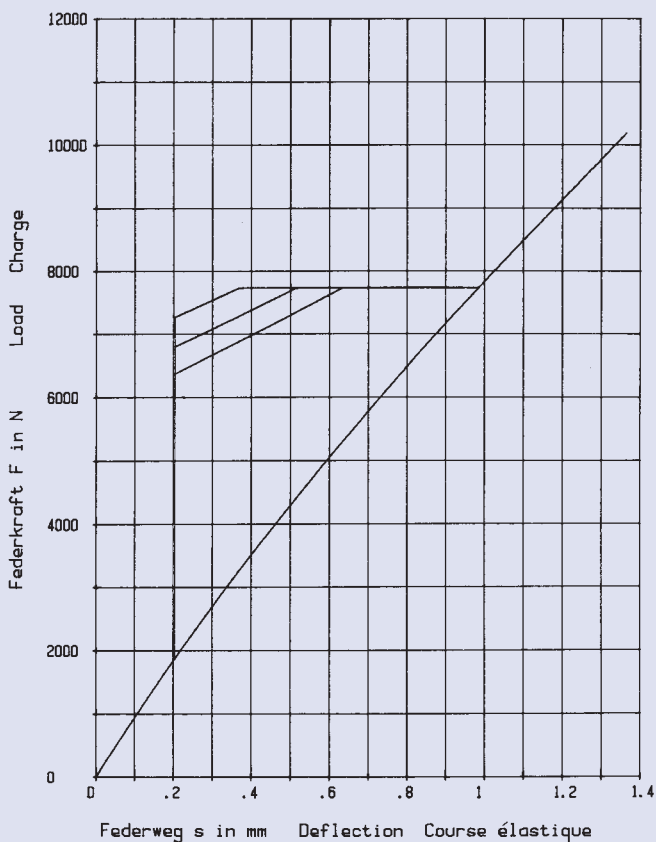

$h_0 = 1,35 \text{ mm}$        $D_e/D_i = 2,45$   
 $t = 2,5 \text{ mm}$        $D_e/t = 20$   
 $h_0/t = 0,54$        $m = 32,118 \text{ g}$

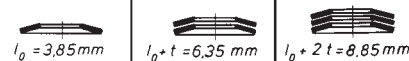

50 x 22,4 x 2,0

GR 2

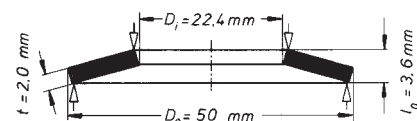
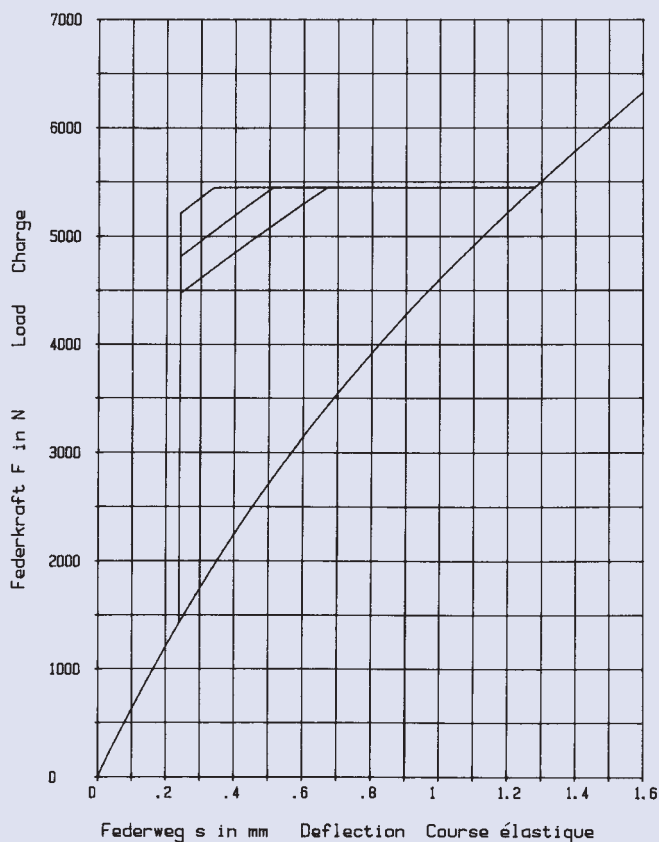

$h_0 = 1,6 \text{ mm}$        $D_e/D_i = 2,232$   
 $t = 2,0 \text{ mm}$        $D_e/t = 25$   
 $h_0/t = 0,8$        $m = 24,639 \text{ g}$

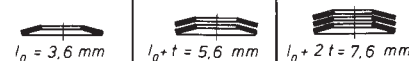

50 x 22,4 x 2,5

GR 2

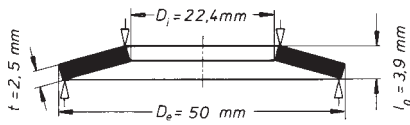

$h_0 = 1,4 \text{ mm}$        $D_e/D_i = 2,232$   
 $t = 2,5 \text{ mm}$        $D_e/t = 20$   
 $h_0/t = 0,56$        $m = 30,8 \text{ g}$

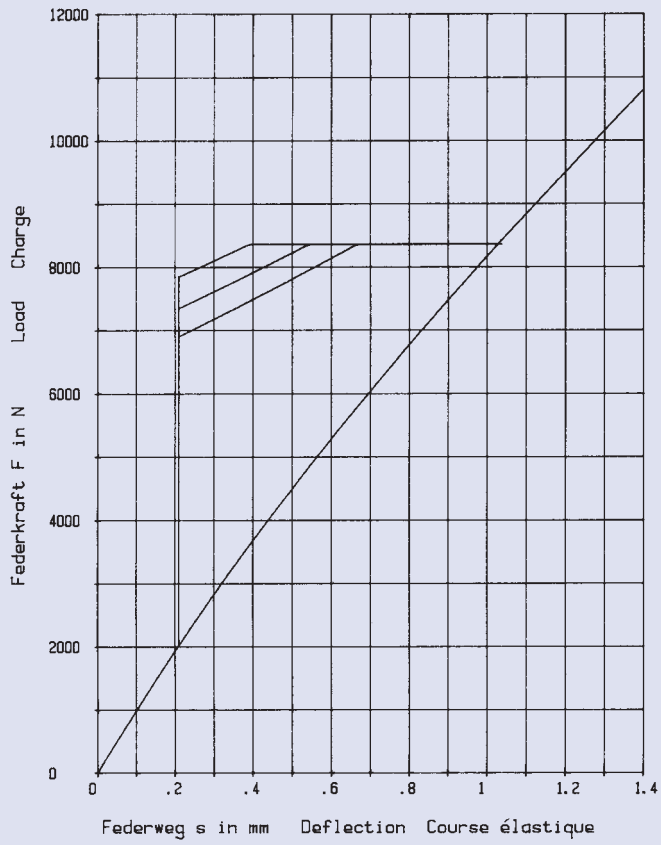
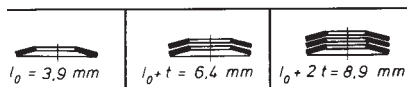

50 x 25,4 x 1,25

GR 2, DIN 2093 – C 50

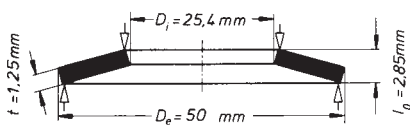

$h_0 = 1,6 \text{ mm}$        $D_e/D_i = 1,968$   
 $t = 1,25 \text{ mm}$        $D_e/t = 40$   
 $h_0/t = 1,28$        $m = 14,294 \text{ g}$

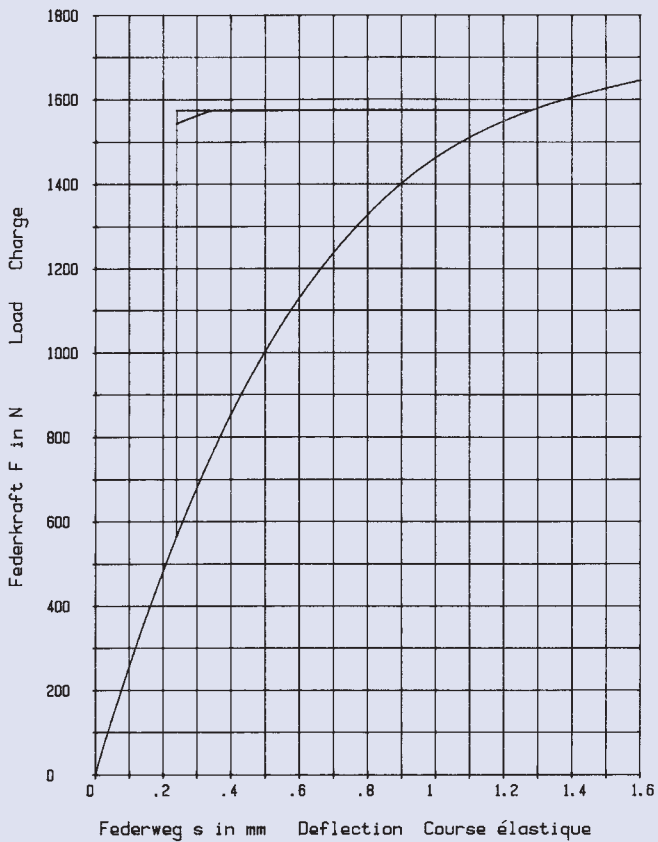
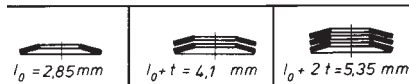

50 x 25,4 x 1,5

GR 2

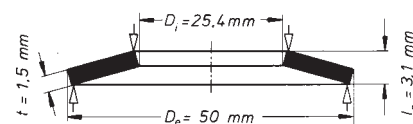
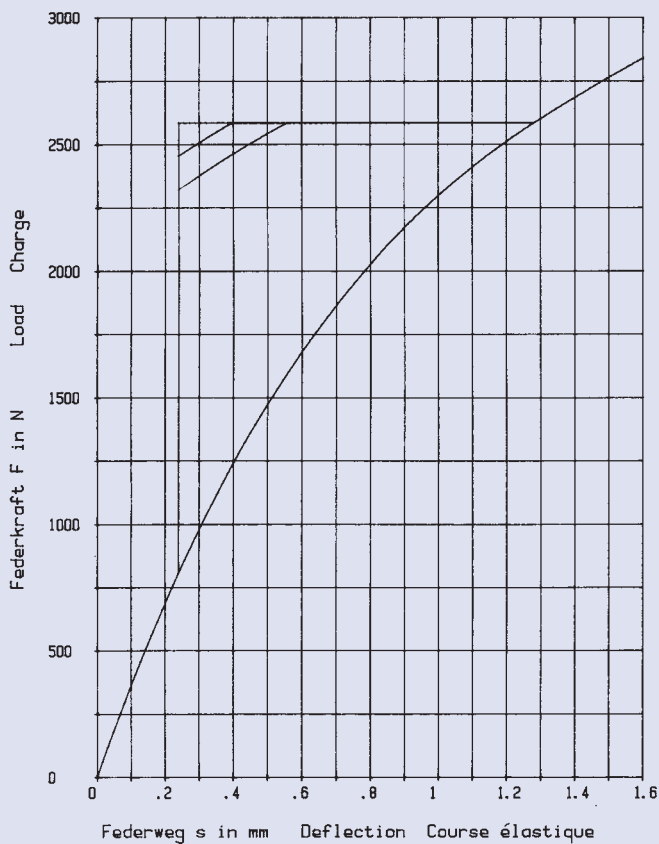

$h_0 = 1,6 \text{ mm}$        $D_e/D_i = 1,968$   
 $t = 1,5 \text{ mm}$        $D_e/t = 33,333$   
 $h_0/t = 1,066$        $m = 17,153 \text{ g}$

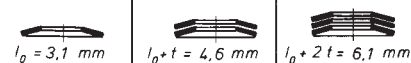

50 x 25,4 x 2,0

GR 2, DIN 2093 – B 50

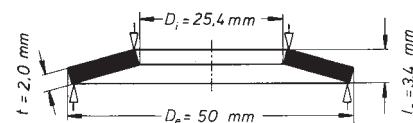
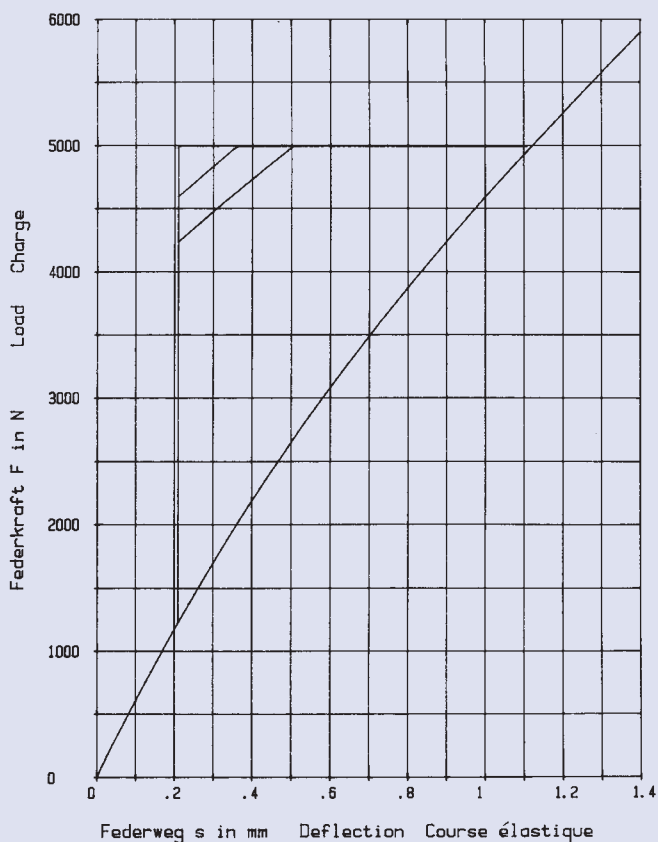

$h_0 = 1,4 \text{ mm}$        $D_e/D_i = 1,968$   
 $t = 2,0 \text{ mm}$        $D_e/t = 25$   
 $h_0/t = 0,7$        $m = 22,871 \text{ g}$

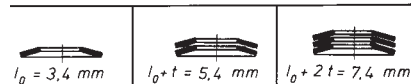

50 x 25,4 x 2,25

GR 2

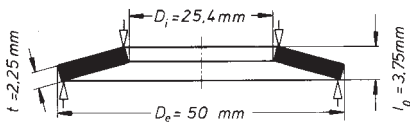

$h_0 = 1,5 \text{ mm}$        $D_e/D_i = 1,968$   
 $t = 2,25 \text{ mm}$        $D_e/t = 22,222$   
 $h_0/t = 0,666$        $m = 25,73 \text{ g}$

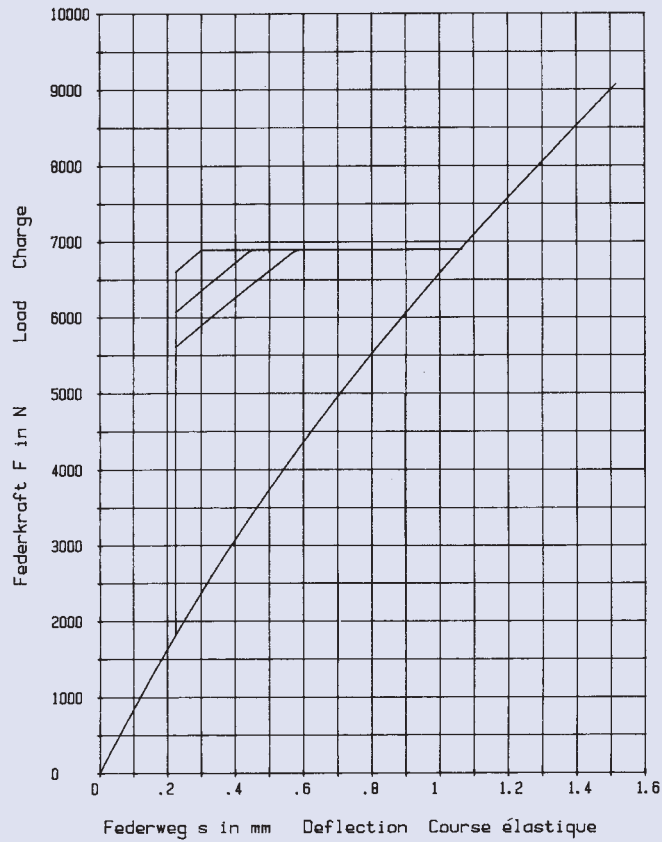
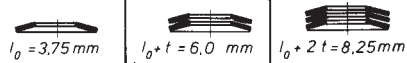

50 x 25,4 x 2,5

GR 2

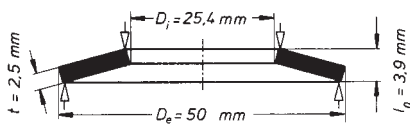

$h_0 = 1,4 \text{ mm}$        $D_e/D_i = 1,968$   
 $t = 2,5 \text{ mm}$        $D_e/t = 20$   
 $h_0/t = 0,56$        $m = 28,589 \text{ g}$

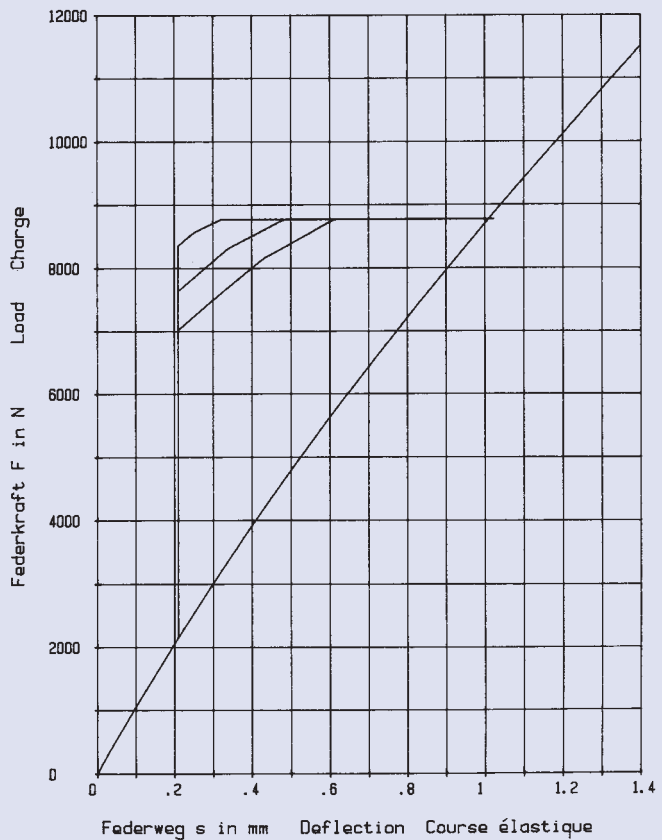
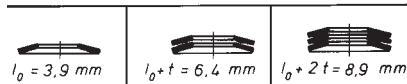

50 x 25,4 x 3,0

GR 2, DIN 2093 – A 50

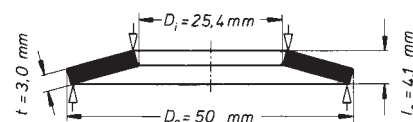
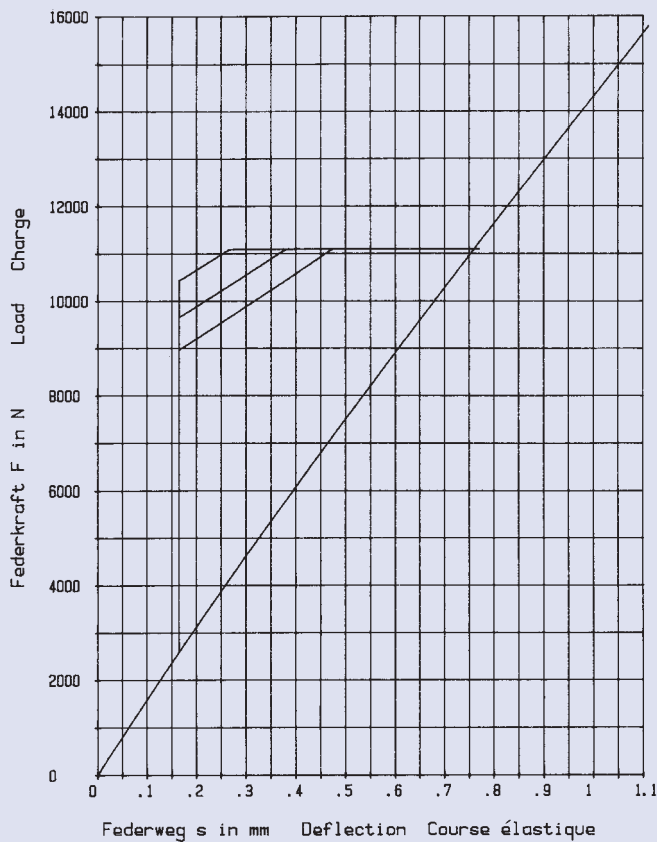

$h_0 = 1,1 \text{ mm}$        $D_e/D_i = 1,968$   
 $t = 3,0 \text{ mm}$        $D_e/t = 16,666$   
 $h_0/t = 0,366$        $m = 34,306 \text{ g}$

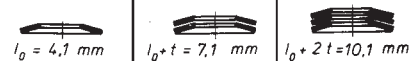

56 x 28,5 x 1,5

GR 2, DIN 2093 – C 56

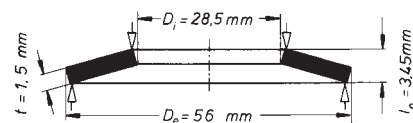
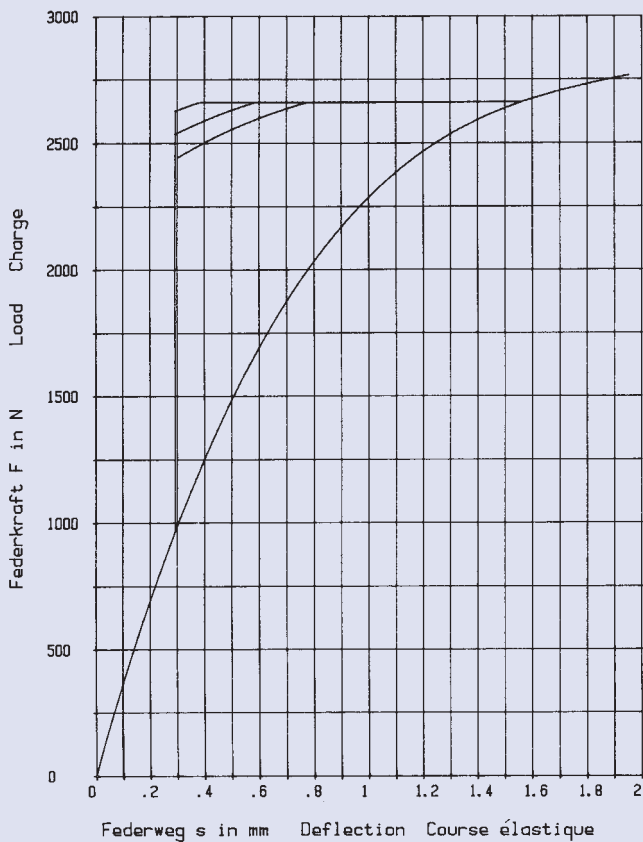

$h_0 = 1,95 \text{ mm}$        $D_e/D_i = 1,964$   
 $t = 1,5 \text{ mm}$        $D_e/t = 37,333$   
 $h_0/t = 1,3$        $m = 21,489 \text{ g}$

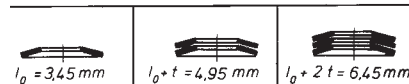

56 x 28,5 x 2,0

GR 2, DIN 2093 – B 56

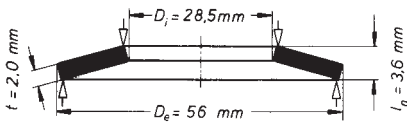

$h_0 = 1,6 \text{ mm}$        $D_e/D_i = 1,964$   
 $t = 2,0 \text{ mm}$        $D_e/t = 28$   
 $h_0/t = 0,8$        $m = 28,653 \text{ g}$

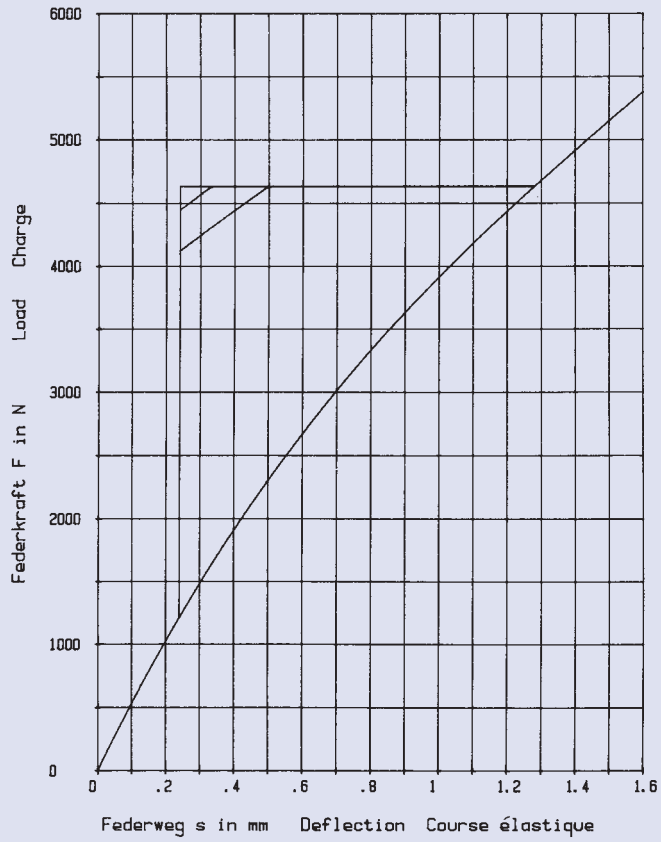
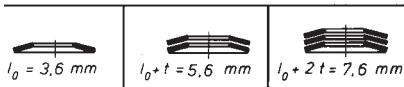

56 x 28,5 x 2,5

GR 2

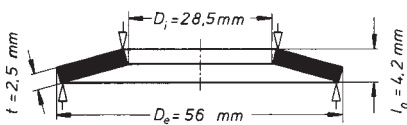

$h_0 = 1,7 \text{ mm}$        $D_e/D_i = 1,964$   
 $t = 2,5 \text{ mm}$        $D_e/t = 22,4$   
 $h_0/t = 0,68$        $m = 35,816 \text{ g}$

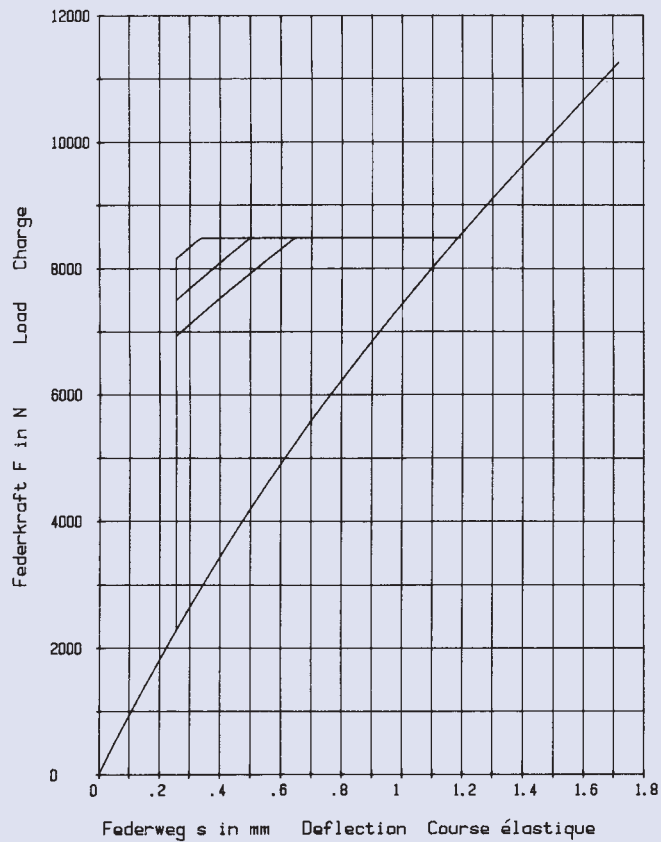
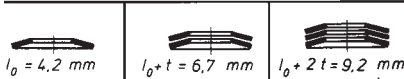



56 x 28,5 x 3,0

GR 2, DIN 2093 – A 56

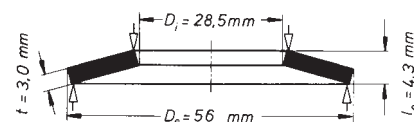
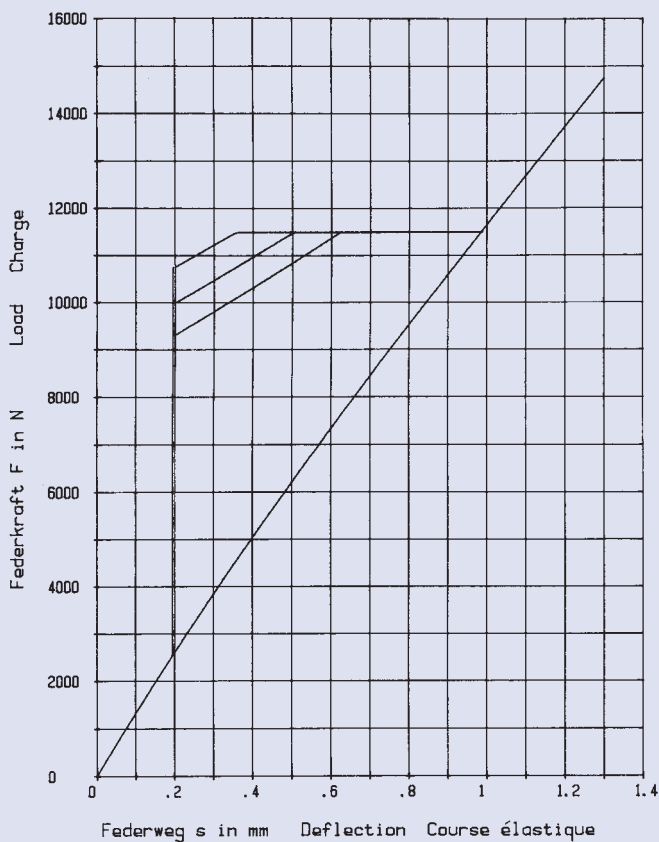

$h_0 = 1,3 \text{ mm}$        $D_e/D_i = 1,964$   
 $t = 3,0 \text{ mm}$        $D_e/t = 18,666$   
 $h_0/t = 0,433$        $m = 42,979 \text{ g}$

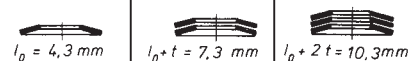

60 x 20,5 x 2,0

GR 2

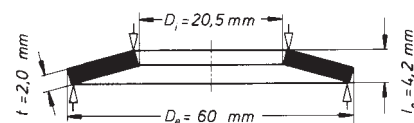
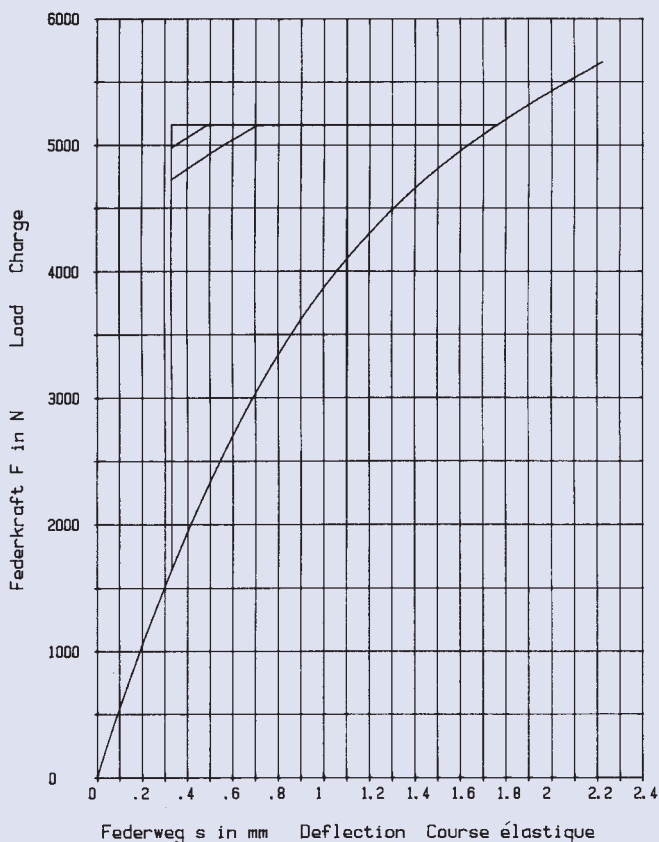

$h_0 = 2,2 \text{ mm}$        $D_e/D_i = 2,926$   
 $t = 2,0 \text{ mm}$        $D_e/t = 30$   
 $h_0/t = 1,1$        $m = 39,208 \text{ g}$

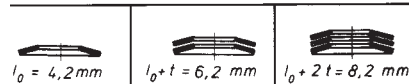

60 x 20,5 x 2,5

GR 2

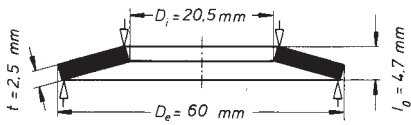

$h_0 = 2,2 \text{ mm}$        $D_e/D_i = 2,926$   
 $t = 2,5 \text{ mm}$        $D_e/t = 24$   
 $h_0/t = 0,88$        $m = 49,0 \text{ g}$

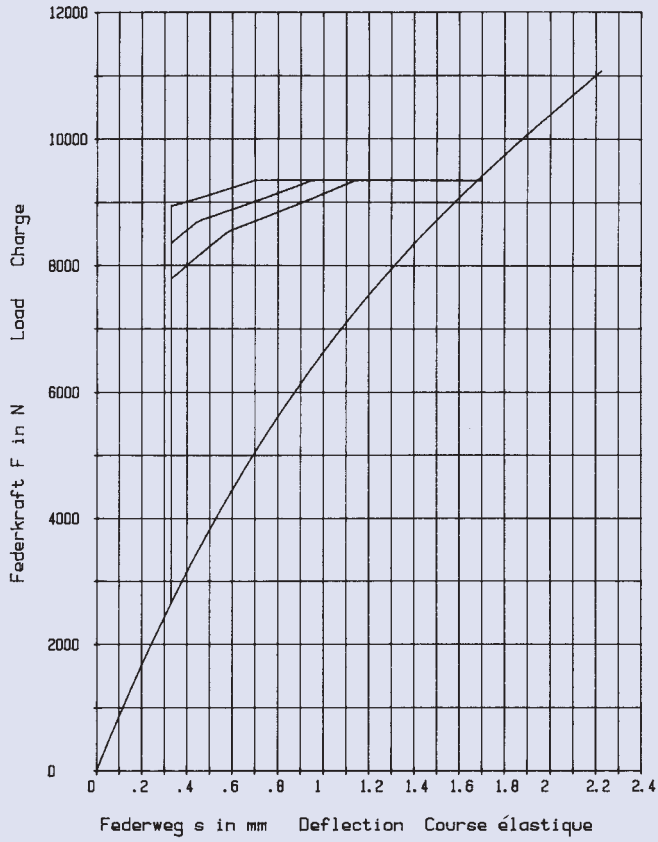
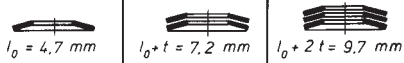

60 x 20,5 x 3,0

GR 2

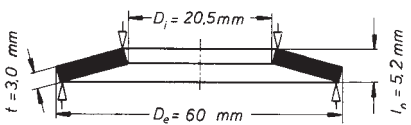

$h_0 = 2,2 \text{ mm}$        $D_e/D_i = 2,926$   
 $t = 3,0 \text{ mm}$        $D_e/t = 20$   
 $h_0/t = 0,733$        $m = 58,811 \text{ g}$

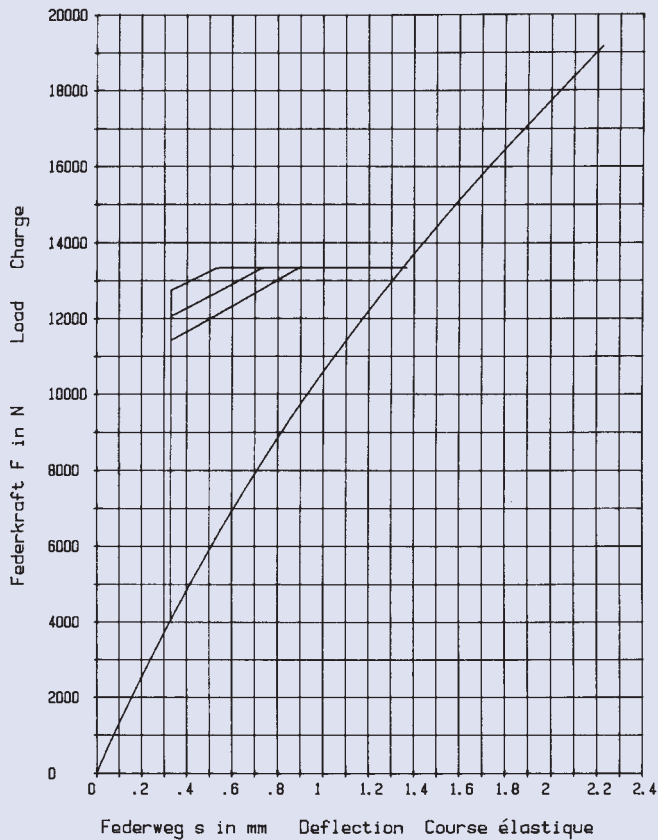
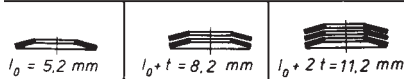

60 x 25,5 x 2,5

GR 2

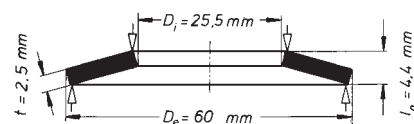
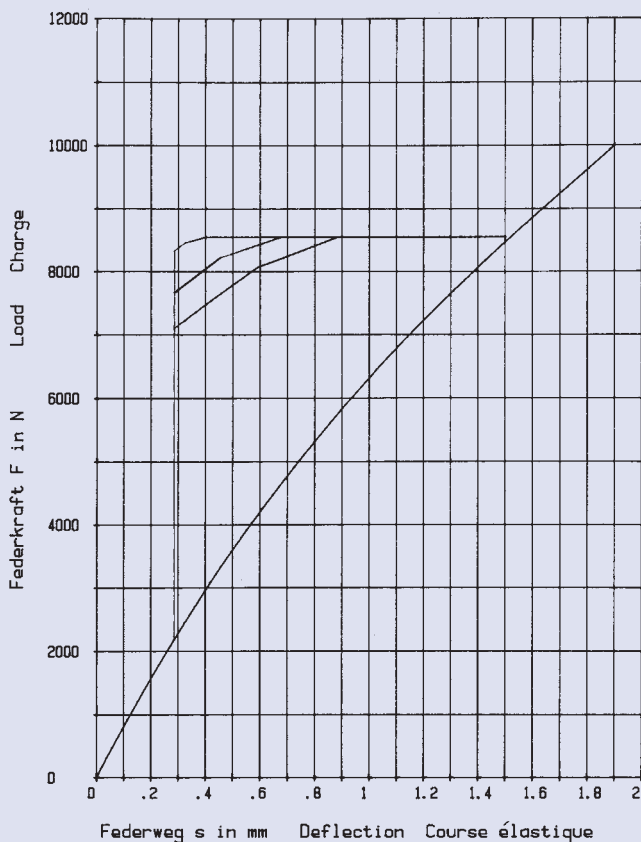

$h_0 = 1,9 \text{ mm}$        $D_e/D_i = 2,352$   
 $t = 2,5 \text{ mm}$        $D_e/t = 24$   
 $h_0/t = 0,76$        $m = 45,464 \text{ g}$

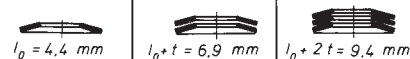

60 x 25,5 x 3,0

GR 2

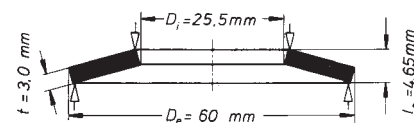
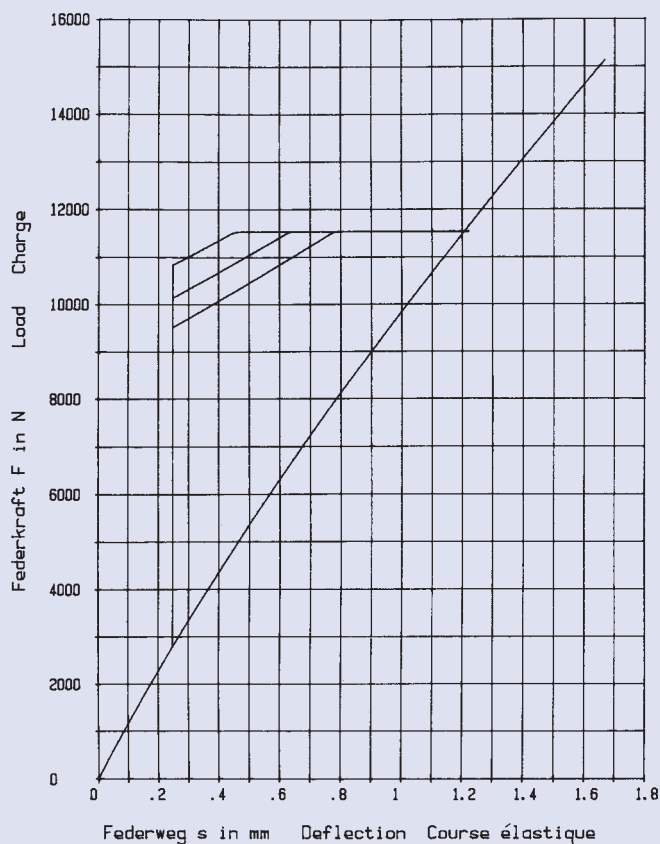

$h_0 = 1,65 \text{ mm}$        $D_e/D_i = 2,352$   
 $t = 3,0 \text{ mm}$        $D_e/t = 20$   
 $h_0/t = 0,55$        $m = 54,557 \text{ g}$

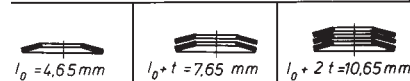

60 x 30,5 x 2,5

GR 2

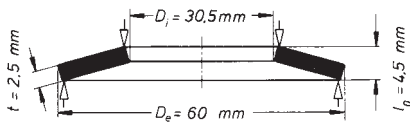

$h_0 = 2,0 \text{ mm}$        $D_e / D_i = 1,967$   
 $t = 2,5 \text{ mm}$        $D_e / t = 24$   
 $h_0 / t = 0,8$        $m = 41,149 \text{ g}$

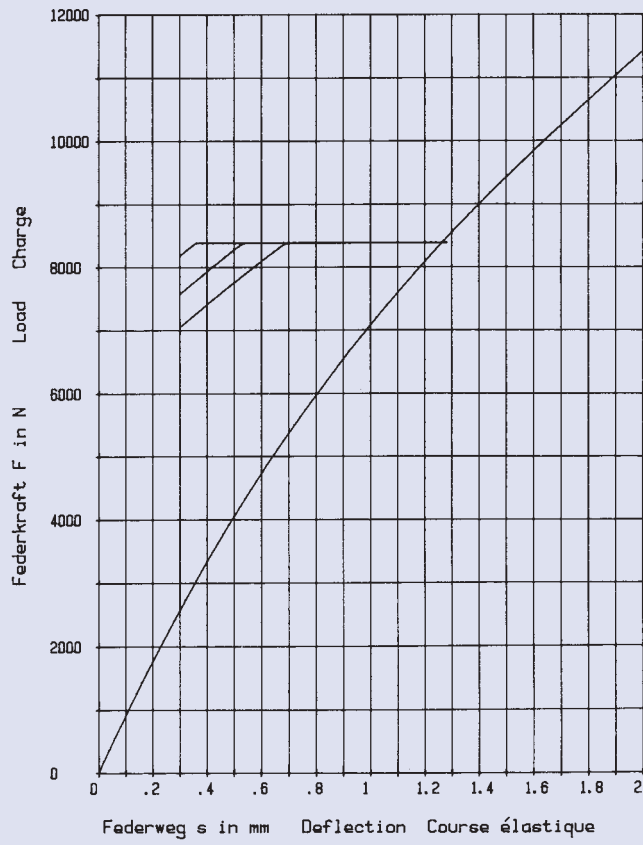
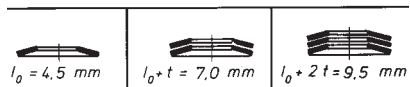

60 x 30,5 x 2,75

GR 2

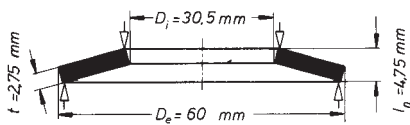

$h_0 = 2,0 \text{ mm}$        $D_e / D_i = 1,967$   
 $t = 2,75 \text{ mm}$        $D_e / t = 21,818$   
 $h_0 / t = 0,727$        $m = 45,264 \text{ g}$

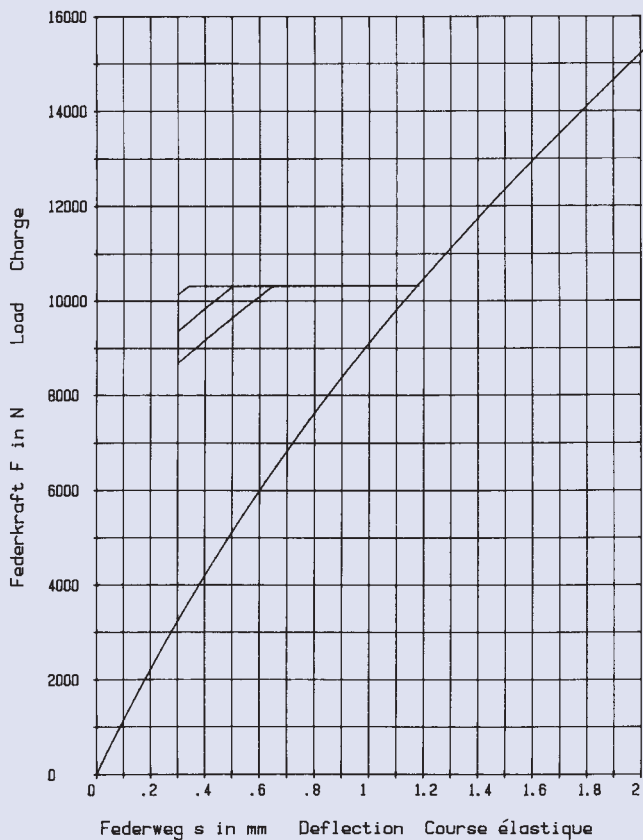
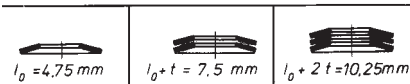

60 x 30,5 x 3,0

GR 2

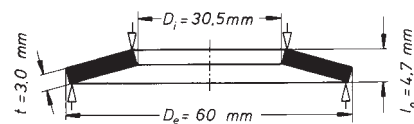
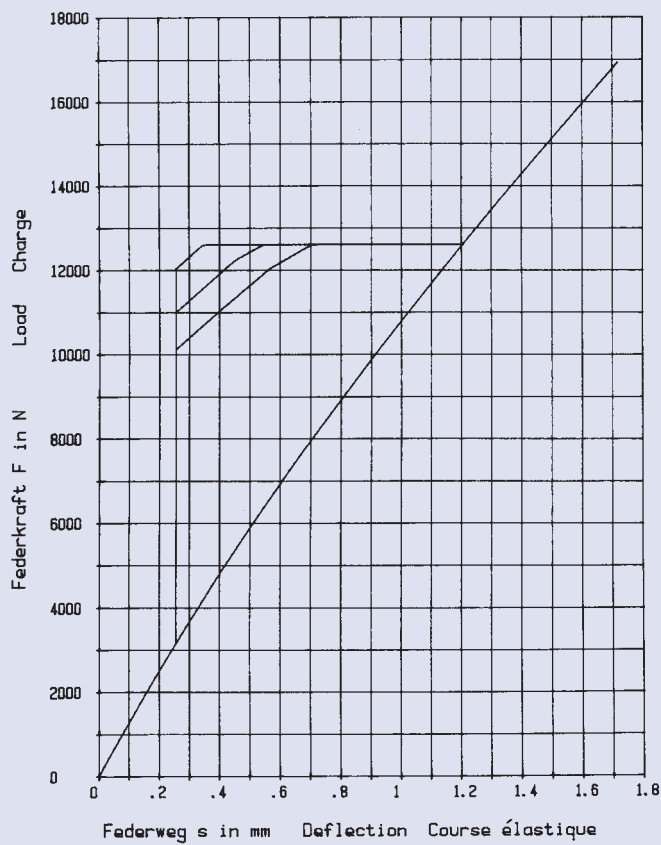

$h_0 = 1,7 \text{ mm}$      $D_e/D_i = 1,967$   
 $t = 3,0 \text{ mm}$      $D_e/t = 20$   
 $h_0/t = 0,566$      $m = 49,379 \text{ g}$



60 x 30,5 x 3,5

GR 2

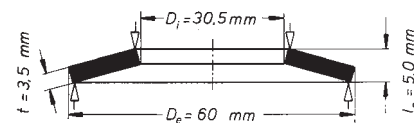
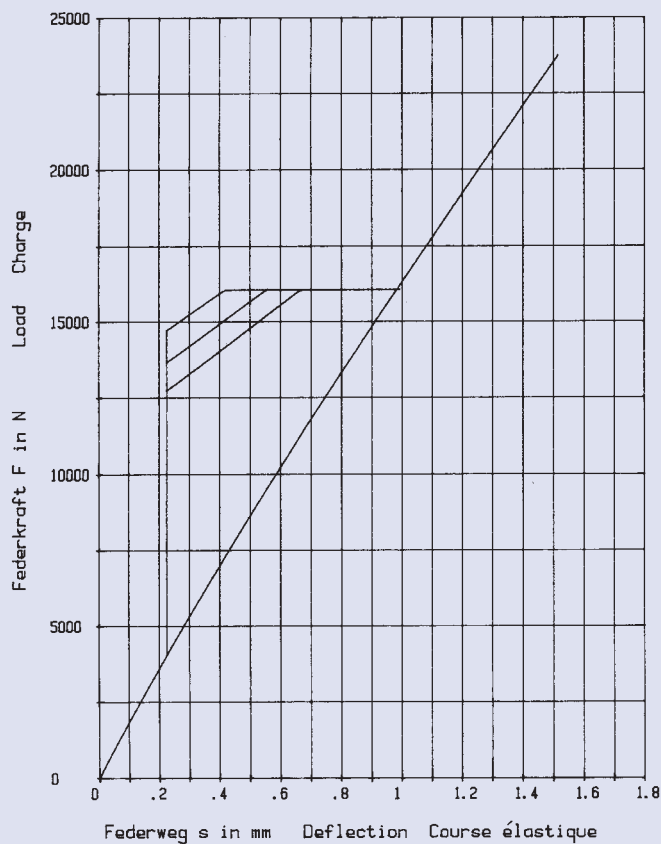

$h_0 = 1,5 \text{ mm}$      $D_e/D_i = 1,967$   
 $t = 3,5 \text{ mm}$      $D_e/t = 17,142$   
 $h_0/t = 0,428$      $m = 57,608 \text{ g}$

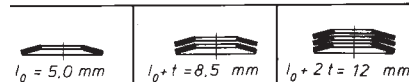

63 x 31 x 1,8

GR 2, DIN 2093 – C 63

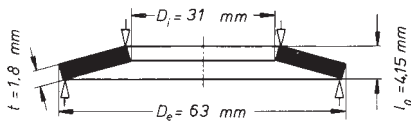

$h_0 = 2,35 \text{ mm}$        $D_e/D_i = 2,032$   
 $t = 1,8 \text{ mm}$        $D_e/t = 35$   
 $h_0/t = 1,305$        $m = 33,381 \text{ g}$

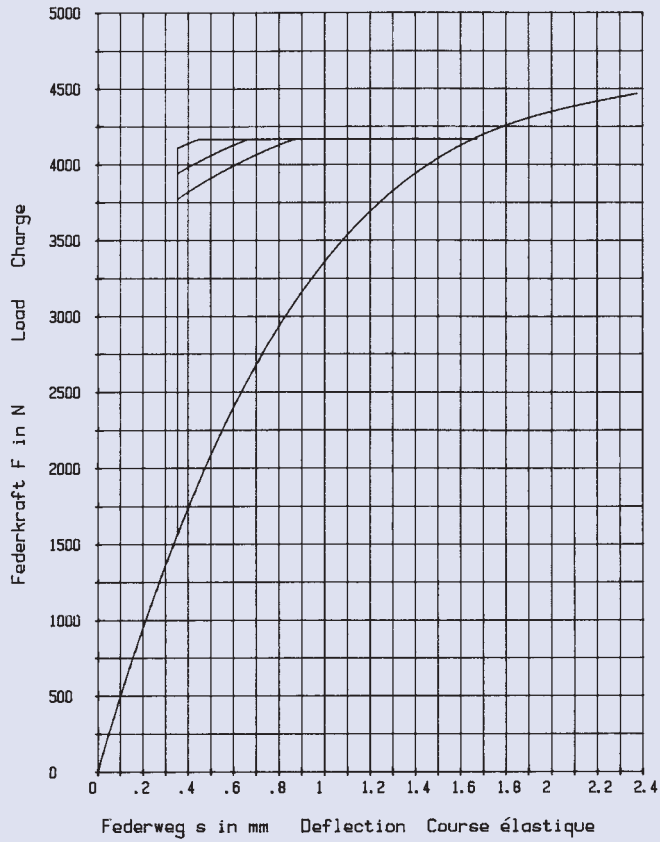
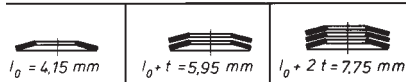

63 x 31 x 2,5

GR 2, DIN 2093 – B 63

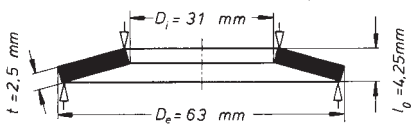

$h_0 = 1,75 \text{ mm}$        $D_e/D_i = 2,032$   
 $t = 2,5 \text{ mm}$        $D_e/t = 25,2$   
 $h_0/t = 0,7$        $m = 46,362 \text{ g}$

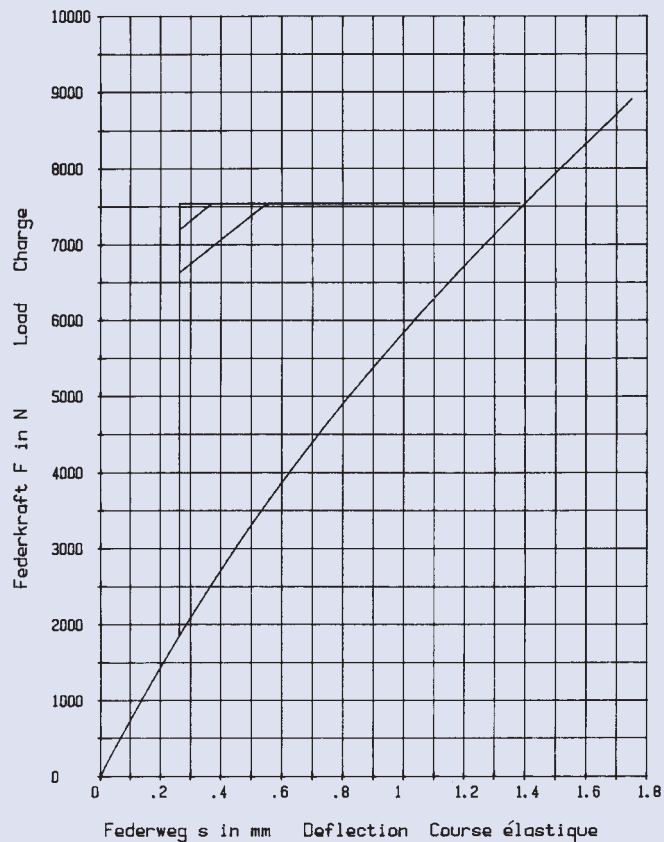
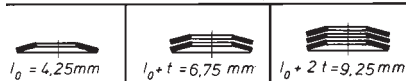

63 x 31 x 3,0

GR 2

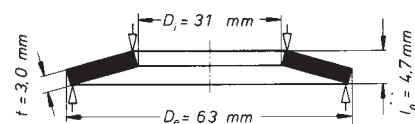
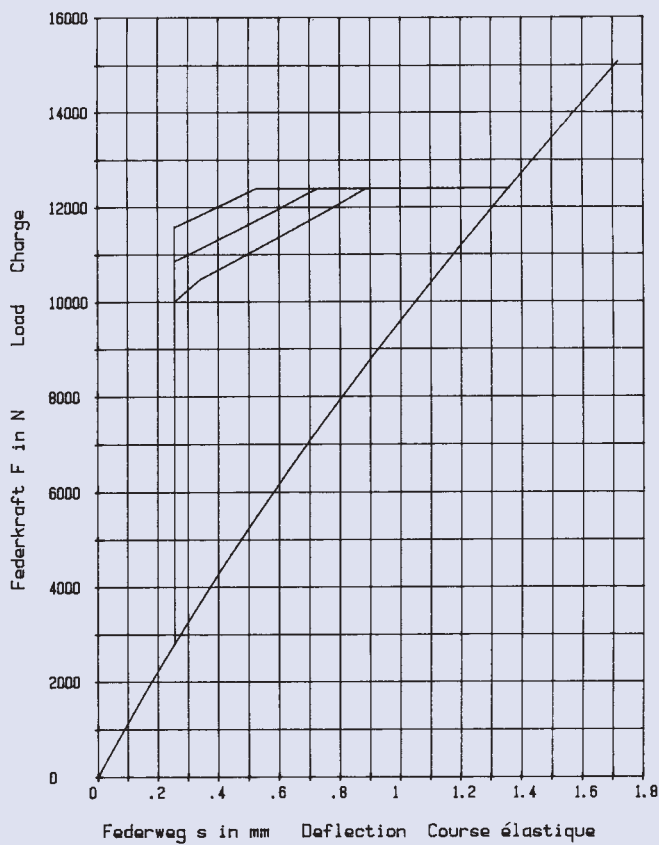

$h_0 = 1,7 \text{ mm}$        $D_e/D_i = 2,032$   
 $t = 3,0 \text{ mm}$        $D_e/t = 21$   
 $h_0/t = 0,566$        $m = 55,635 \text{ g}$

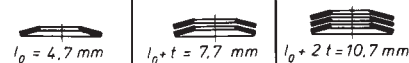

63 x 31 x 3,5

GR 2, DIN 2093 – A 63

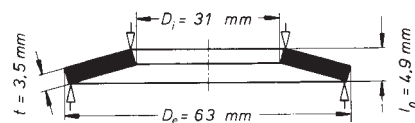
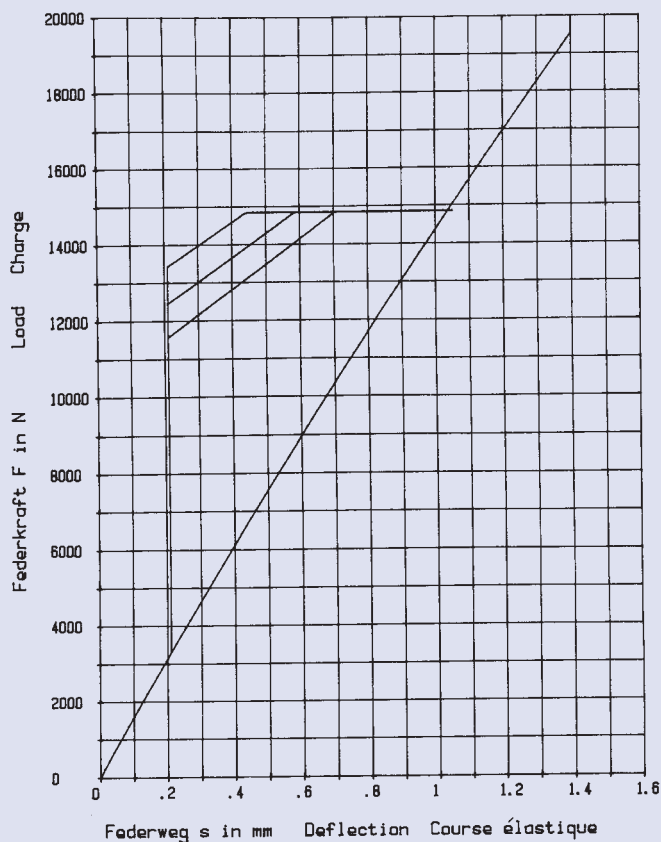

$h_0 = 1,4 \text{ mm}$        $D_e/D_i = 2,032$   
 $t = 3,5 \text{ mm}$        $D_e/t = 18$   
 $h_0/t = 0,4$        $m = 64,907 \text{ g}$

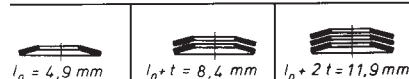

70 x 24,5 x 3,0

GR 2

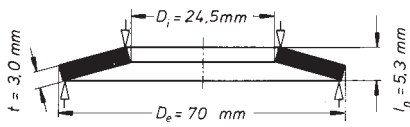

$h_0 = 2.3 \text{ mm}$        $D_e/D_i = 2.857$   
 $t = 3.0 \text{ mm}$        $D_e/t = 23.333$   
 $h_0/t = 0.766$        $m = 79.526 \text{ g}$

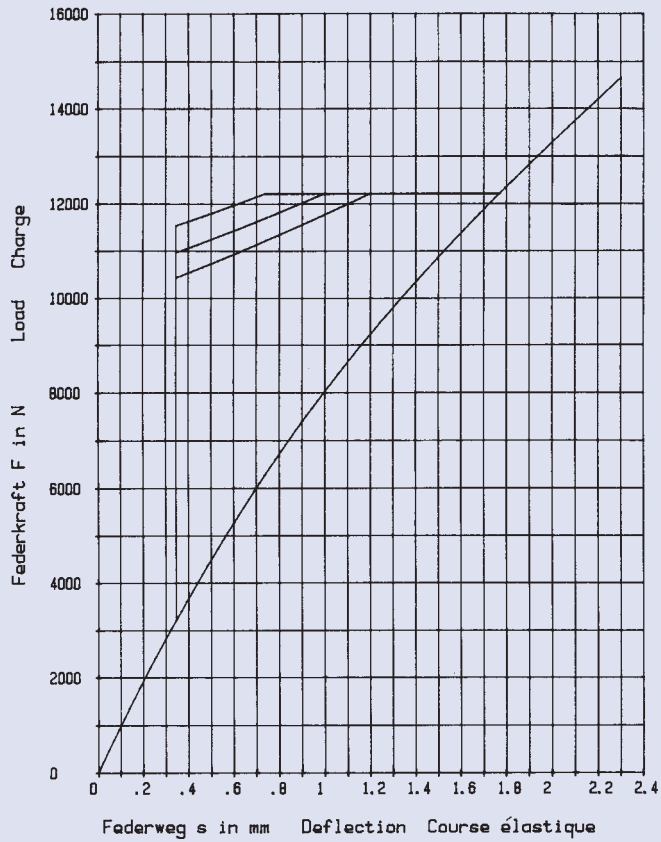
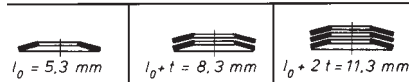

70 x 24,5 x 3,5

GR 2

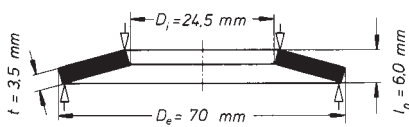

$h_0 = 2.5 \text{ mm}$        $D_e/D_i = 2.857$   
 $t = 3.5 \text{ mm}$        $D_e/t = 20$   
 $h_0/t = 0.714$        $m = 92.781 \text{ g}$

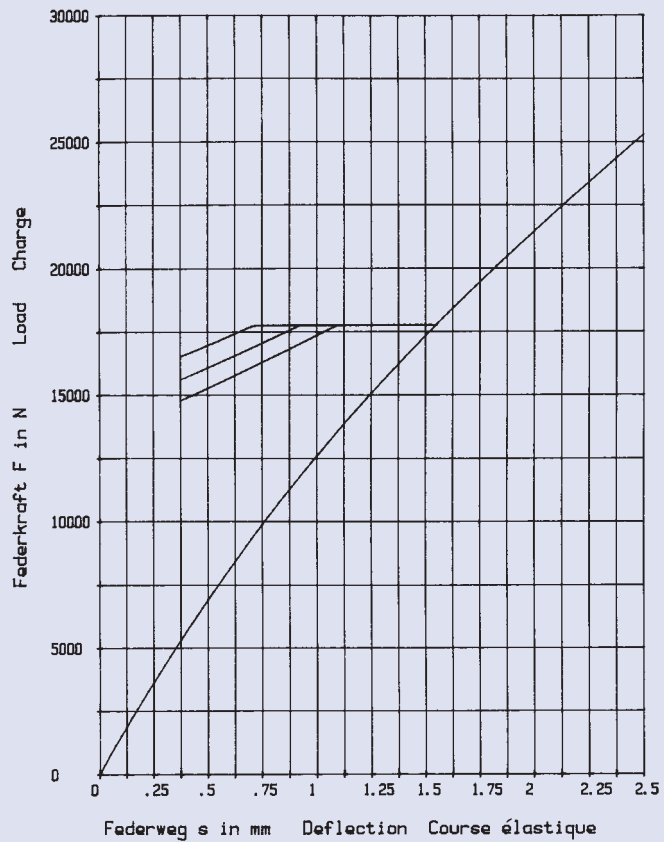
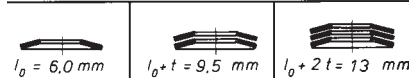



70 x 25,5 x 2,0

GR 2

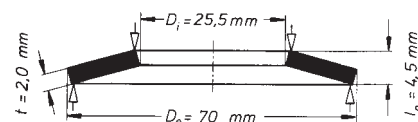
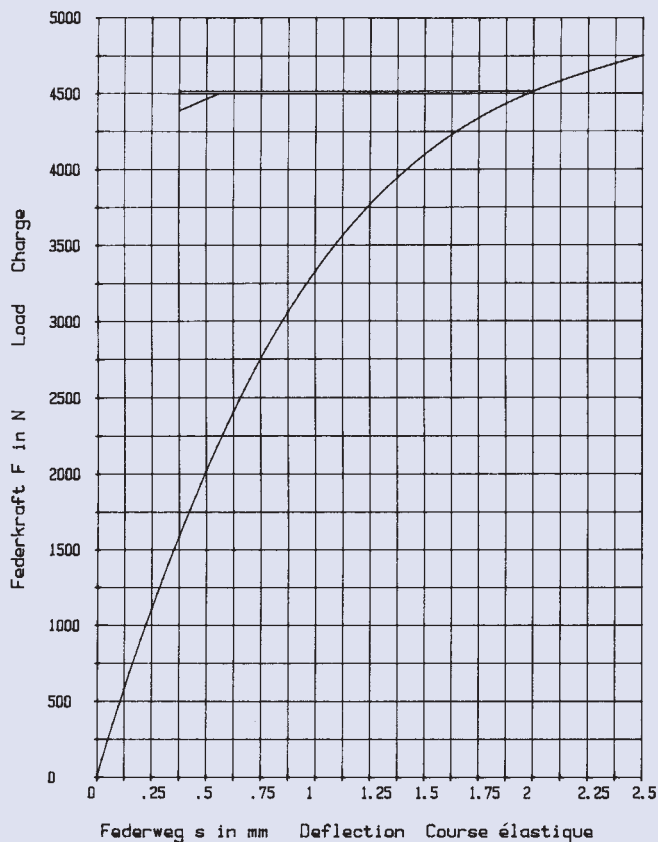

$h_0 = 2,5 \text{ mm}$        $D_e/D_i = 2,745$   
 $t = 2,0 \text{ mm}$        $D_e/t = 35$   
 $h_0/t = 1,25$        $m = 52,401 \text{ g}$

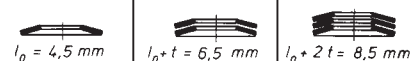

70 x 30,5 x 2,5

GR 2

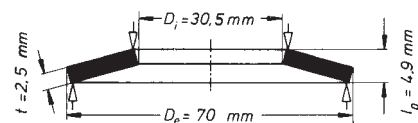
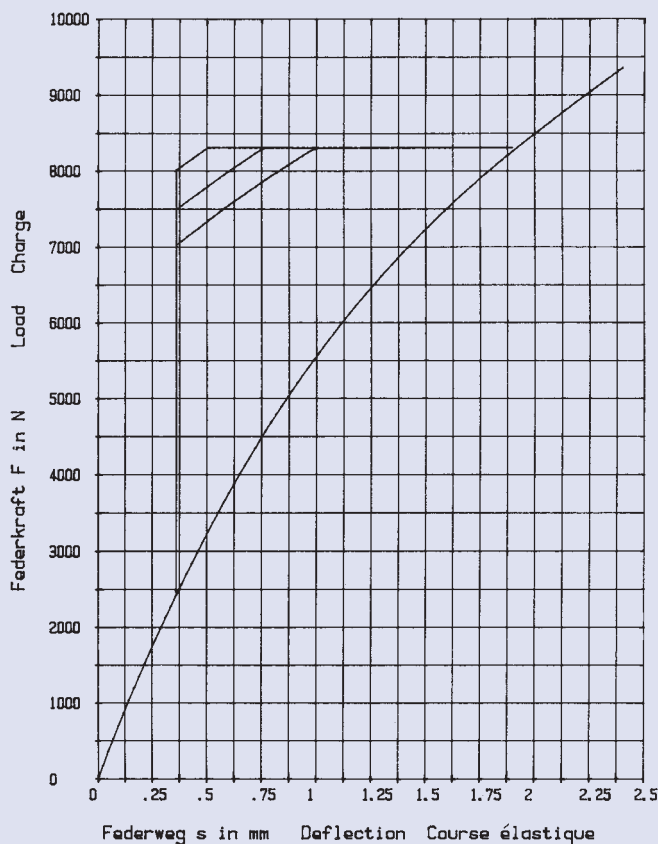

$h_0 = 2,4 \text{ mm}$        $D_e/D_i = 2,295$   
 $t = 2,5 \text{ mm}$        $D_e/t = 28$   
 $h_0/t = 0,96$        $m = 61,186 \text{ g}$

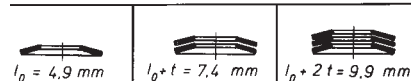

70 x 30,5 x 3,0

GR 2

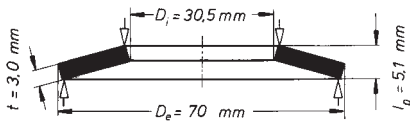

$h_0 = 2,1 \text{ mm}$        $D_e/D_i = 2,295$   
 $t = 3,0 \text{ mm}$        $D_e/t = 23,333$   
 $h_0/t = 0,7$        $m = 73,423 \text{ g}$

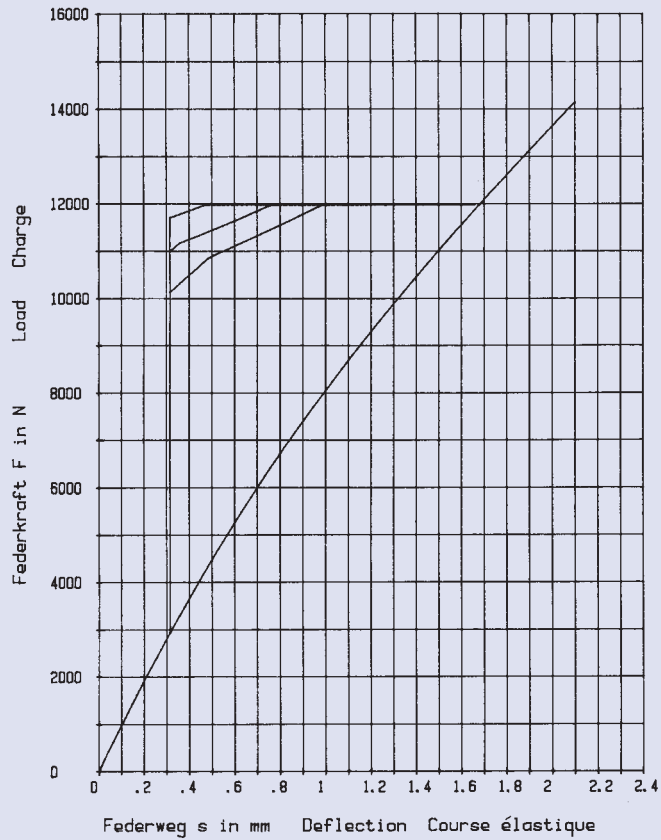
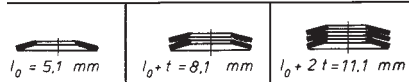

70 x 35,5 x 3,0

GR 2

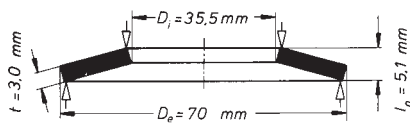

$h_0 = 2,1 \text{ mm}$        $D_e/D_i = 1,971$   
 $t = 3,0 \text{ mm}$        $D_e/t = 23,333$   
 $h_0/t = 0,7$        $m = 67,319 \text{ g}$

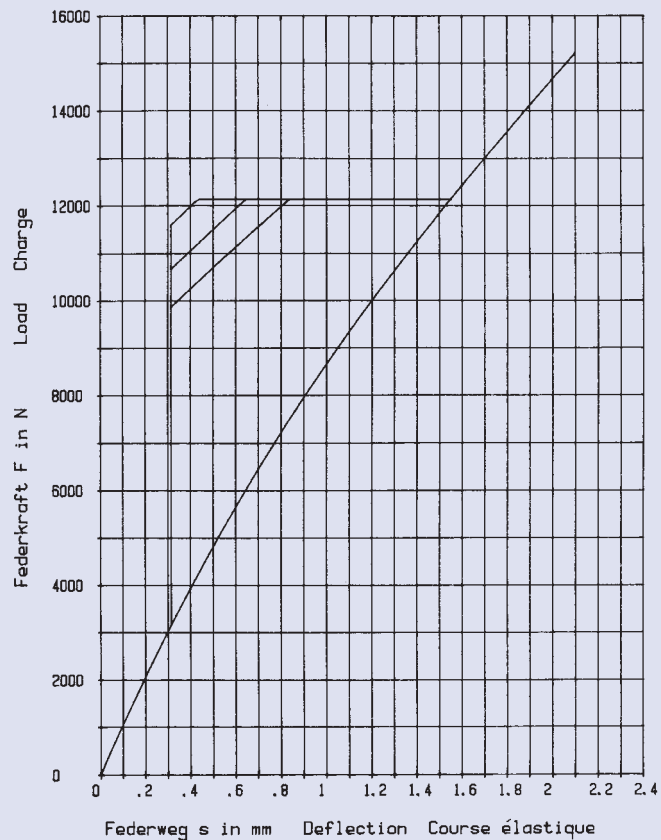
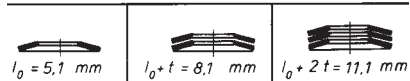

70 x 35,5 x 3,5

GR 2

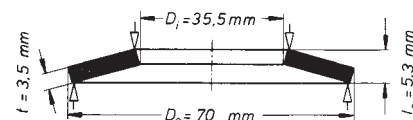
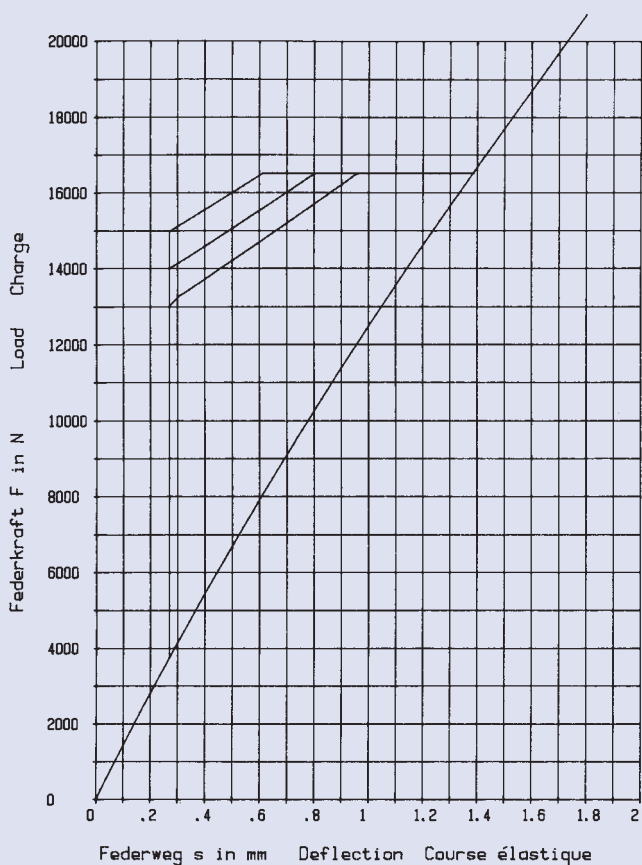

$h_0 = 1,8 \text{ mm}$        $D_e / D_i = 1,971$   
 $t = 3,5 \text{ mm}$        $D_e / t = 20$   
 $h_0 / t = 0,514$        $m = 78,539 \text{ g}$



70 x 35,5 x 4,0

GR 2

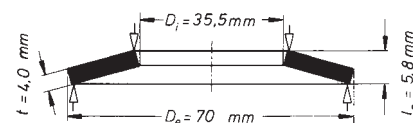
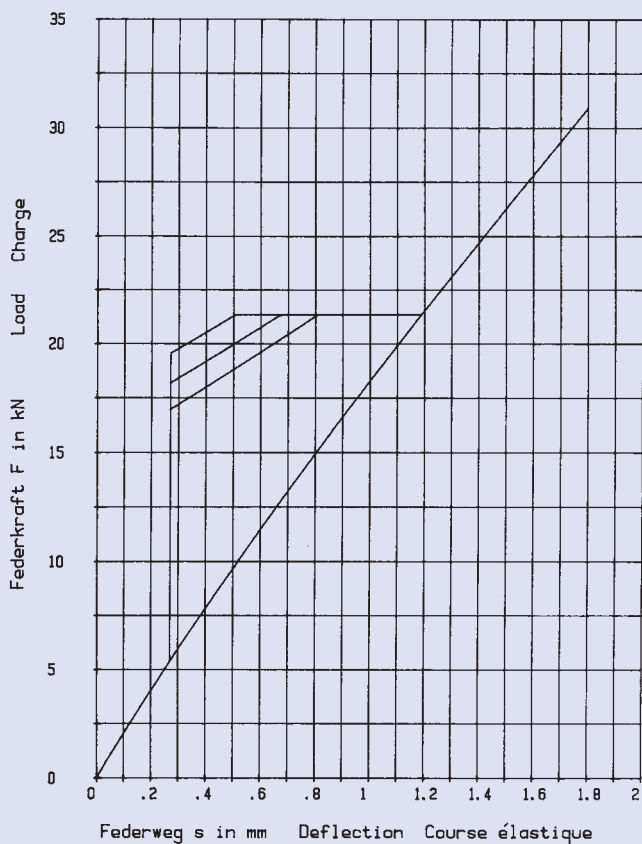

$h_0 = 1,8 \text{ mm}$        $D_e / D_i = 1,971$   
 $t = 4,0 \text{ mm}$        $D_e / t = 17,5$   
 $h_0 / t = 0,45$        $m = 89,759 \text{ g}$

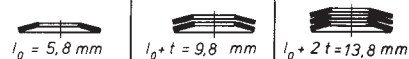

70 x 40,5 x 4,0

GR 2

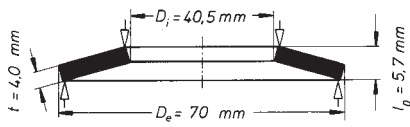

$h_0 = 1,7 \text{ mm}$        $D_e/D_i = 1,728$   
 $t = 4,0 \text{ mm}$        $D_e/t = 17,5$   
 $h_0/t = 0,425$        $m = 80,388 \text{ g}$

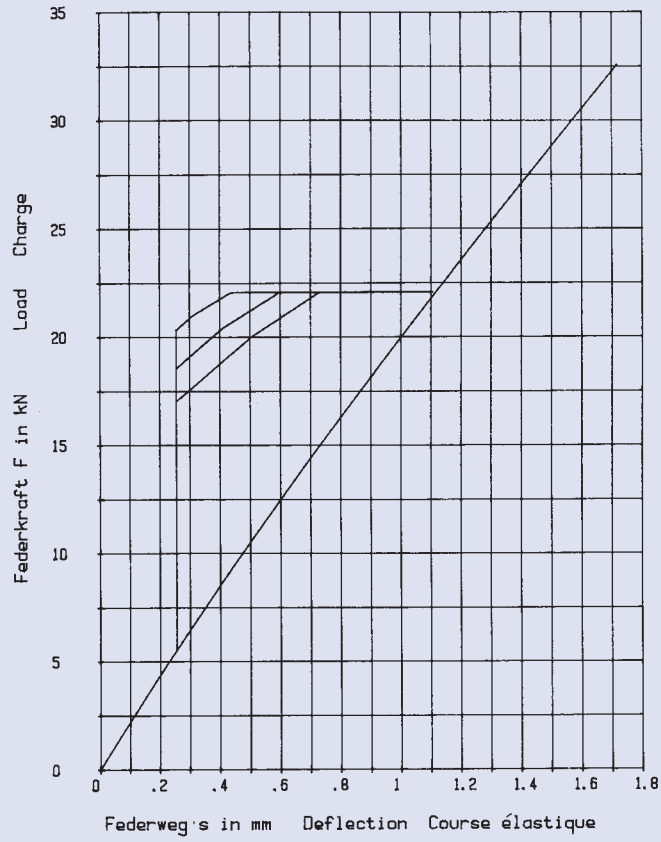
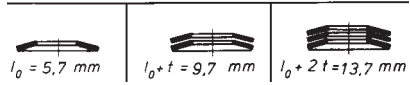

70 x 40,5 x 5,0

GR 2

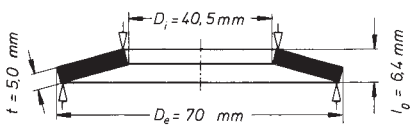

$h_0 = 1,4 \text{ mm}$        $D_e/D_i = 1,728$   
 $t = 5,0 \text{ mm}$        $D_e/t = 14$   
 $h_0/t = 0,28$        $m = 100,485 \text{ g}$

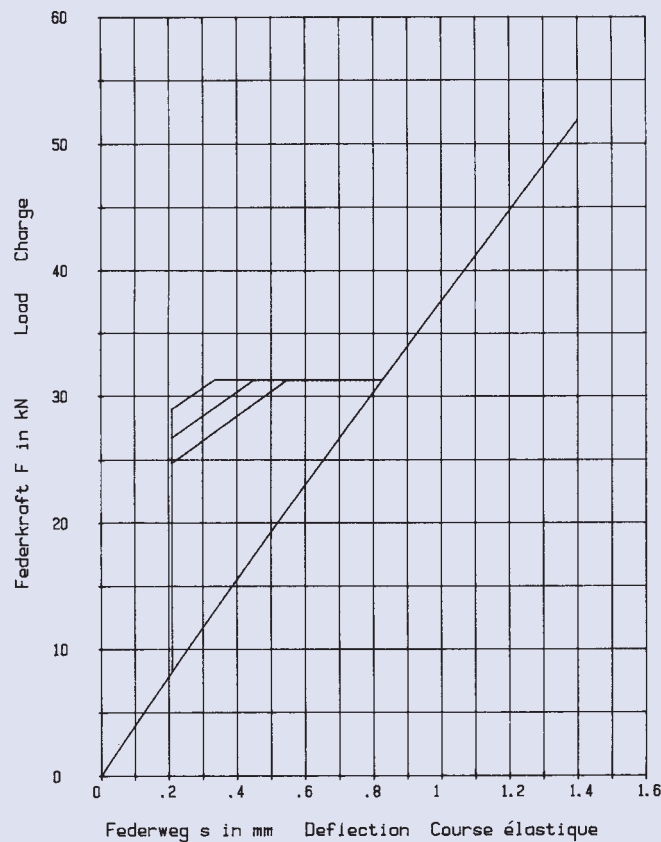
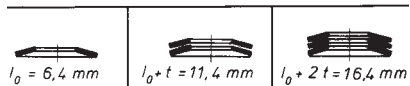

71 x 36 x 2,0

GR 2, DIN 2093 – C 71

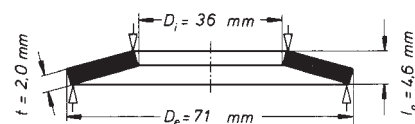
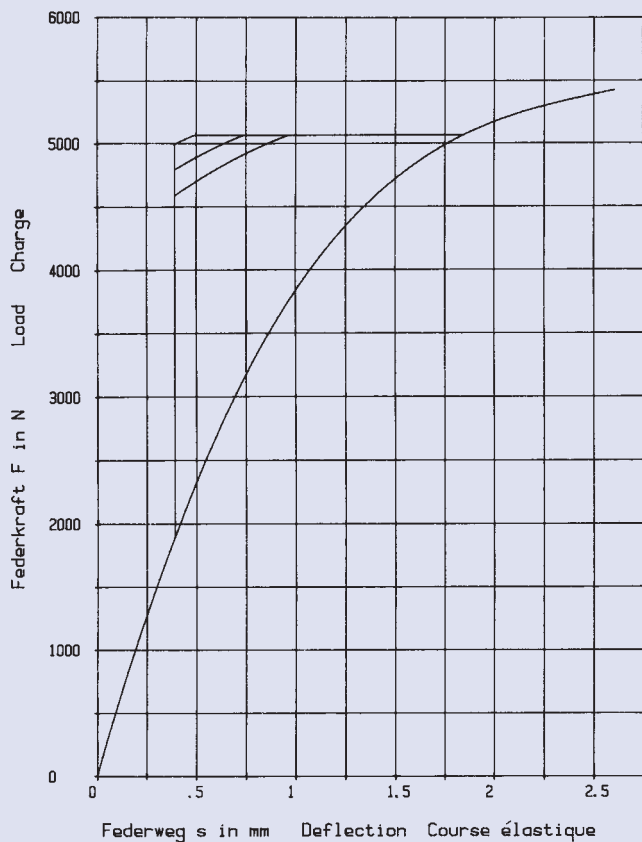

$h_0 = 2,6 \text{ mm}$        $D_e/D_i = 1,972$   
 $t = 2,0 \text{ mm}$        $D_e/t = 35,5$   
 $h_0/t = 1,3$        $m = 46,177 \text{ g}$

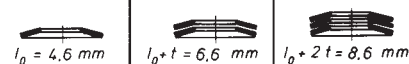

71 x 36 x 2,5

GR 2, DIN 2093 – B 71

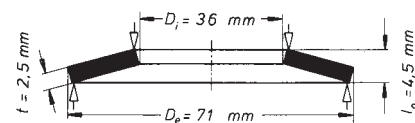
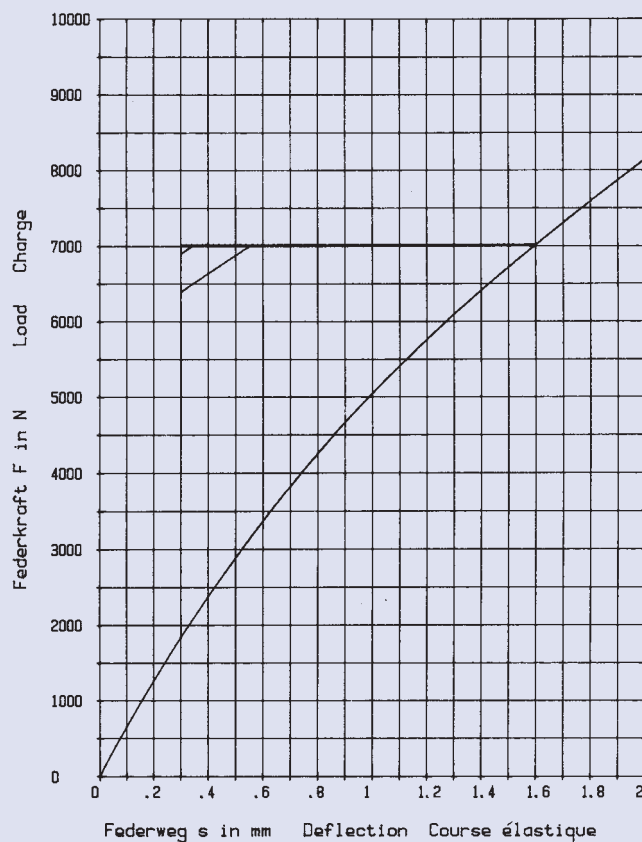

$h_0 = 2,0 \text{ mm}$        $D_e/D_i = 1,972$   
 $t = 2,5 \text{ mm}$        $D_e/t = 28,4$   
 $h_0/t = 0,8$        $m = 57,722 \text{ g}$

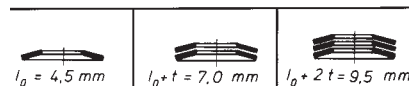

71 x 36 x 4,0

GR 2, DIN 2093 – A 71

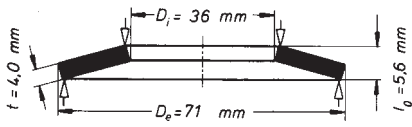

$h_0 = 1,6 \text{ mm}$        $D_e/D_i = 1,972$   
 $t = 4,0 \text{ mm}$        $D_e/t = 17,75$   
 $h_0/t = 0,4$        $m = 92,355 \text{ g}$

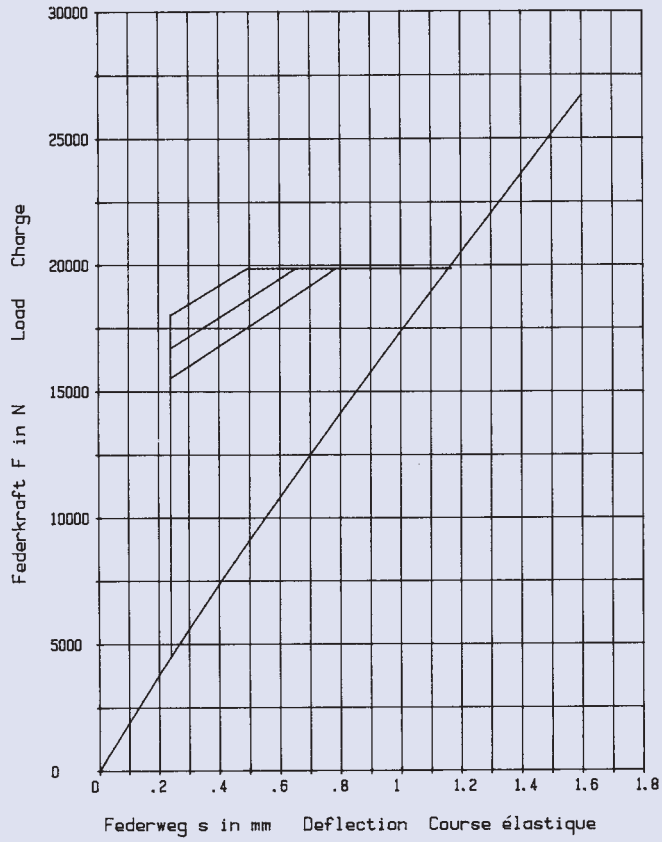
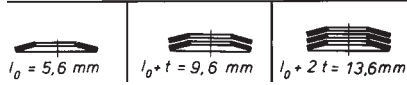

80 x 30,5 x 2,5

GR 2

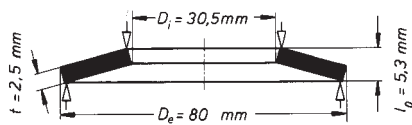

$h_0 = 2,8 \text{ mm}$        $D_e/D_i = 2,622$   
 $t = 2,5 \text{ mm}$        $D_e/t = 32$   
 $h_0/t = 1,12$        $m = 84,305 \text{ g}$

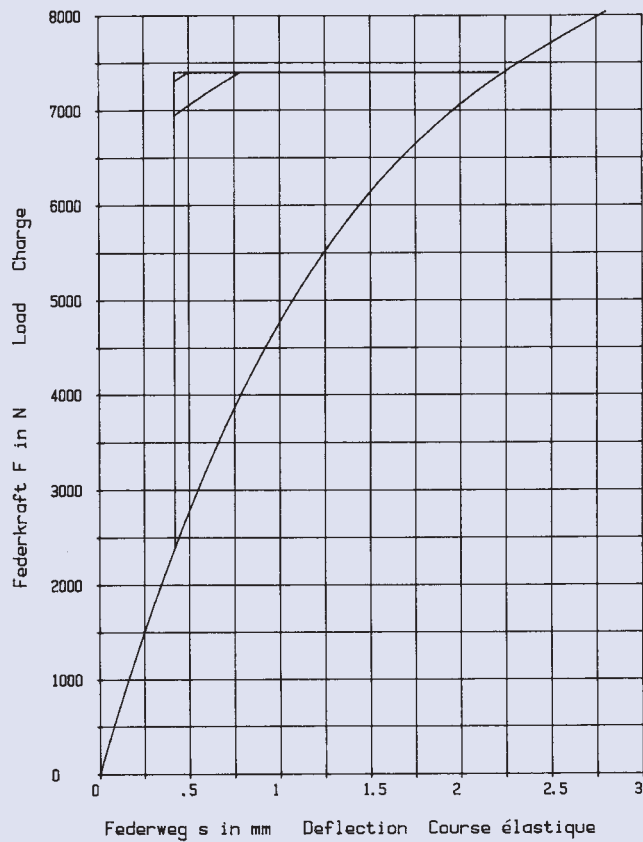
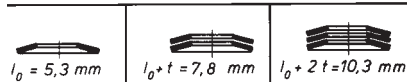

80 x 31 x 3,0

GR 2

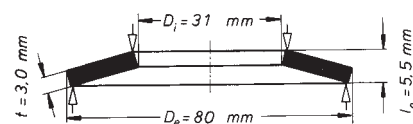
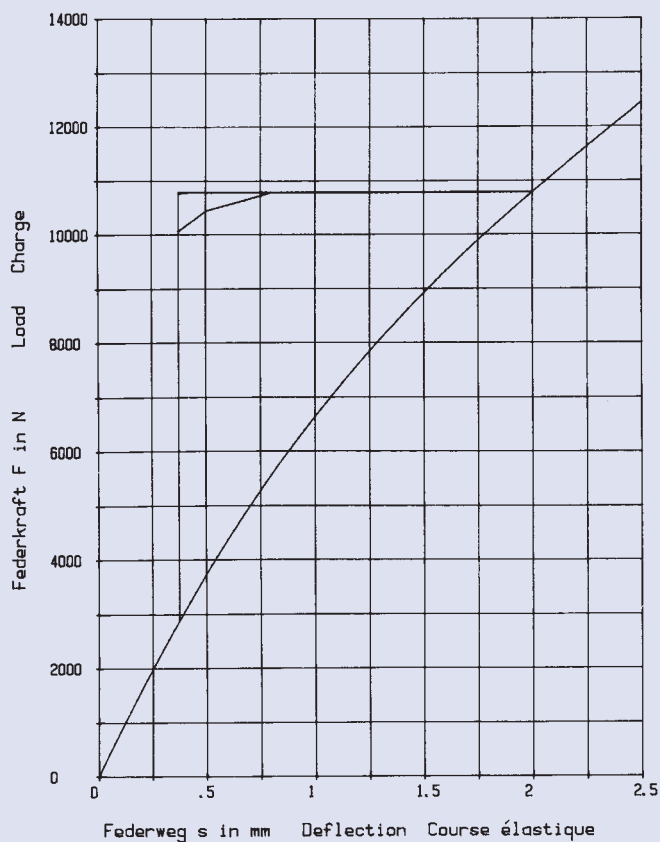

$h_0 = 2,5 \text{ mm}$        $D_e/D_i = 2,58$   
 $t = 3,0 \text{ mm}$        $D_e/t = 26,666$   
 $h_0/t = 0,833$        $m = 100,60 \text{ g}$



80 x 31 x 4,0

GR 2

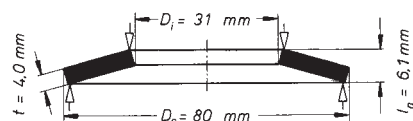
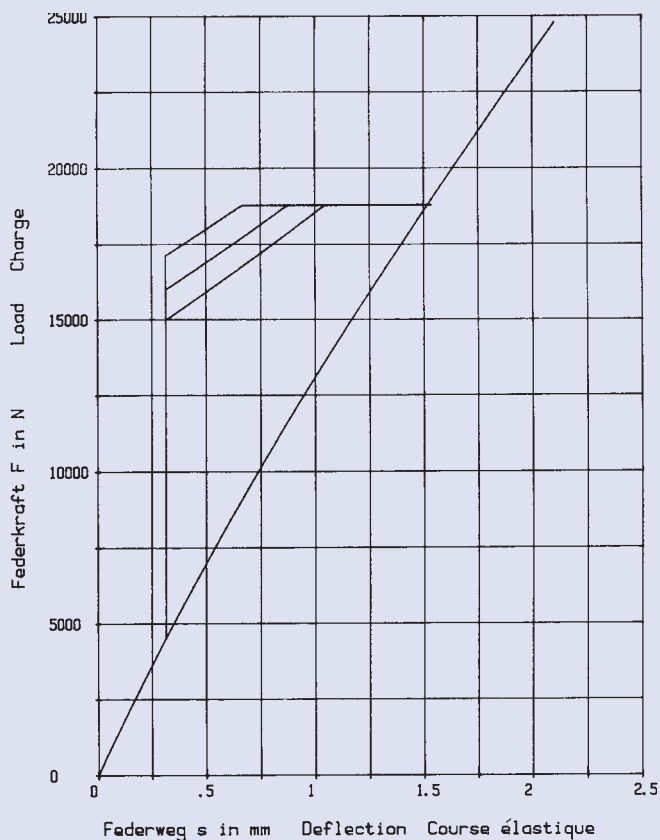

$h_0 = 2,1 \text{ mm}$        $D_e/D_i = 2,58$   
 $t = 4,0 \text{ mm}$        $D_e/t = 20$   
 $h_0/t = 0,525$        $m = 134,13 \text{ g}$

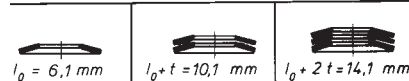

80 x 35,5 x 4,0

GR 2

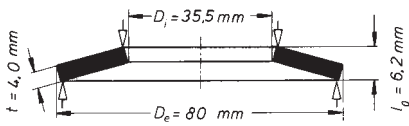

$h_0 = 2,2 \text{ mm}$        $D_e/D_i = 2,253$   
 $t = 4,0 \text{ mm}$        $D_e/t = 20$   
 $h_0/t = 0,55$        $m = 126,75 \text{ g}$

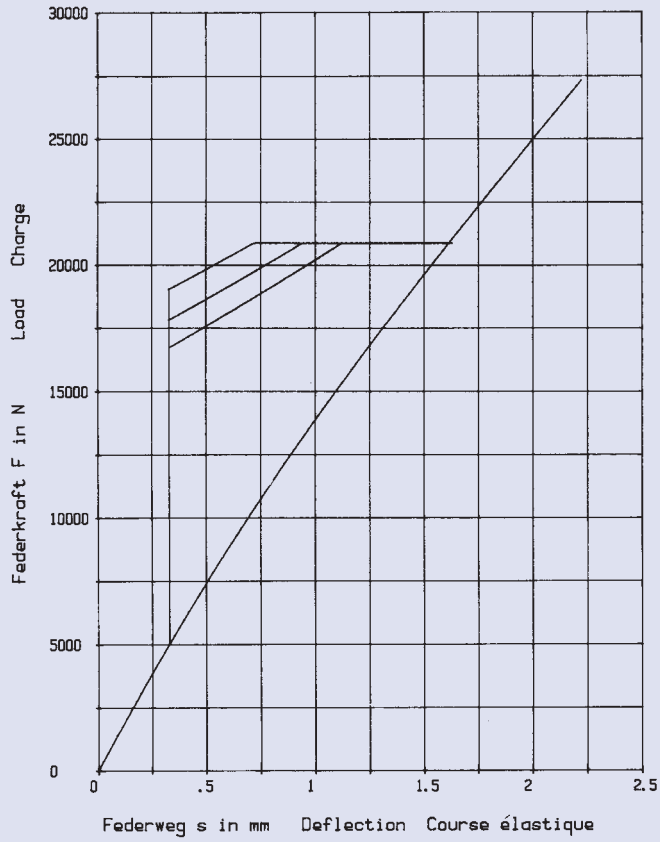
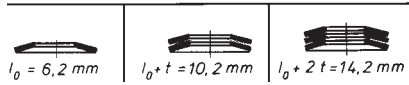

80 x 36 x 3,0

GR 2

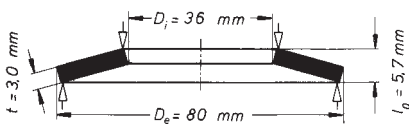

$h_0 = 2,7 \text{ mm}$        $D_e/D_i = 2,222$   
 $t = 3,0 \text{ mm}$        $D_e/t = 26,666$   
 $h_0/t = 0,9$        $m = 94,401 \text{ g}$

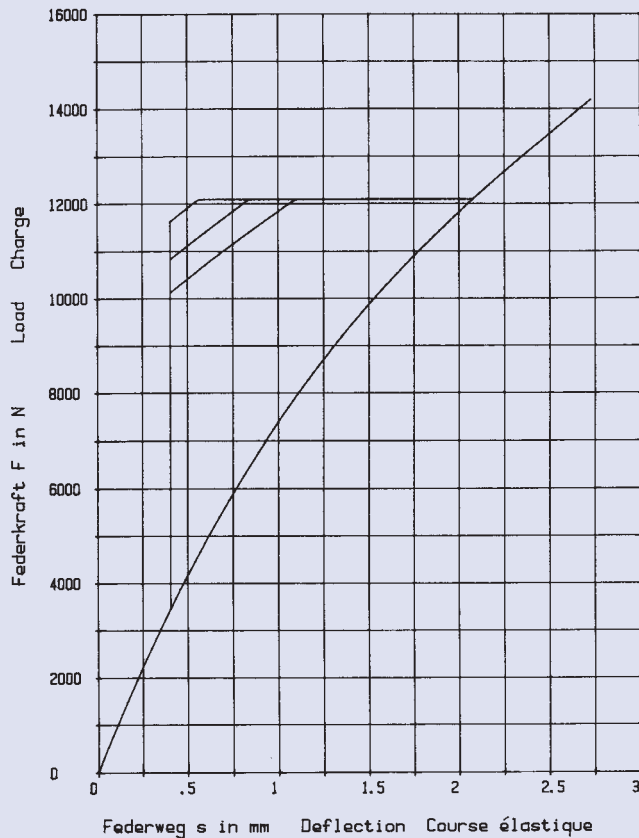
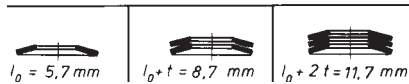



80 x 41 x 2,25

GR 2, DIN 2093 – C 80

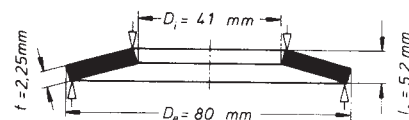
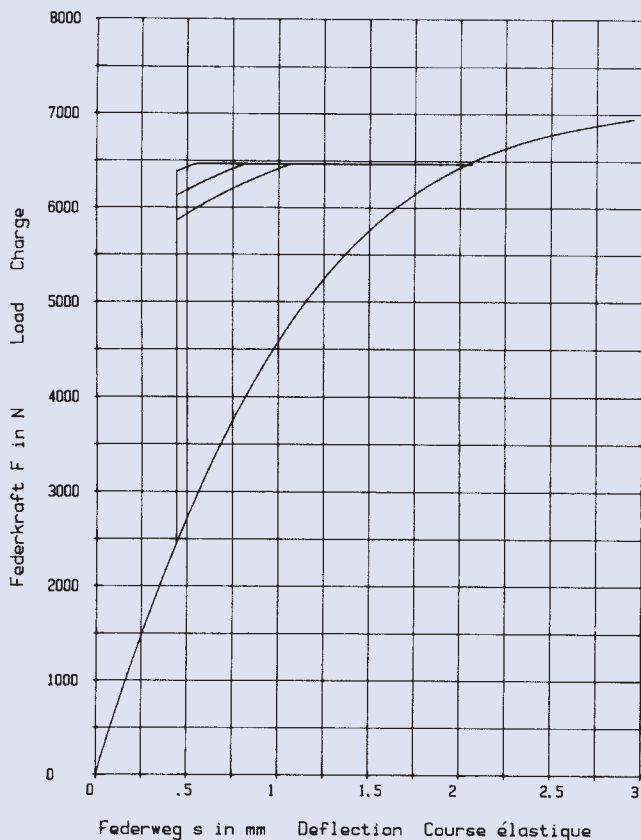

$h_0 = 2,95 \text{ mm}$        $D_e/D_1 = 1,951$   
 $t = 2,25 \text{ mm}$        $D_e/t = 35,555$   
 $h_0/t = 1,311$        $m = 65,460 \text{ g}$

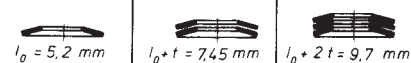

80 x 41 x 3,0

GR 2, DIN 2093 – B 80

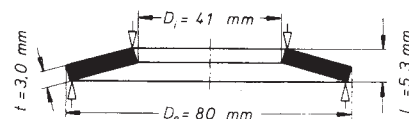
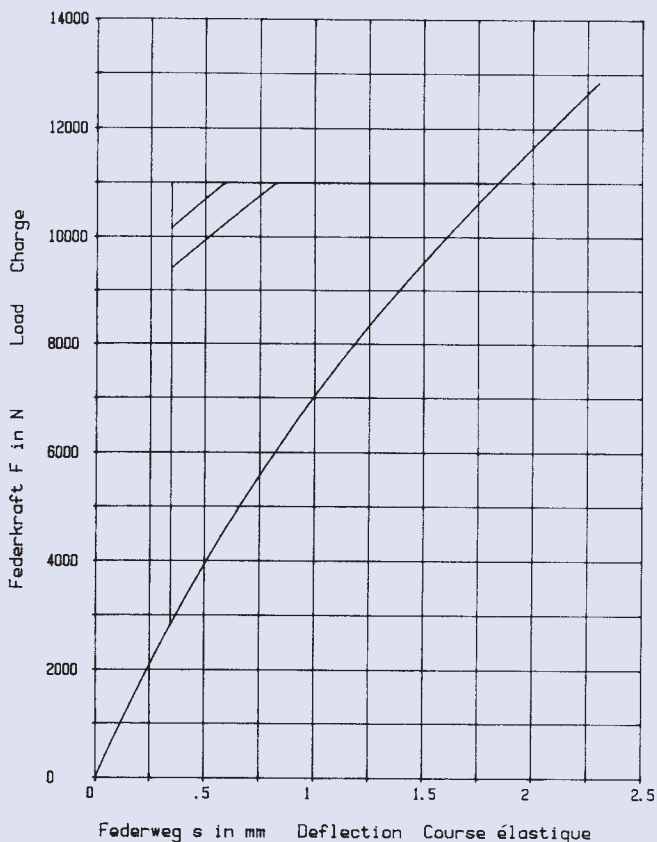

$h_0 = 2,3 \text{ mm}$        $D_e/D_1 = 1,951$   
 $t = 3,0 \text{ mm}$        $D_e/t = 26,666$   
 $h_0/t = 0,766$        $m = 87,281 \text{ g}$

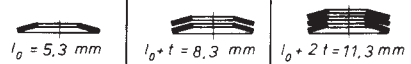

80 x 41 x 4,0

GR 2

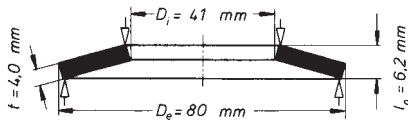

$h_0 = 2,2 \text{ mm}$        $D_e / D_i = 1,951$   
 $t = 4,0 \text{ mm}$        $D_e / t = 20$   
 $h_0 / t = 0,55$        $m = 116,374 \text{ g}$

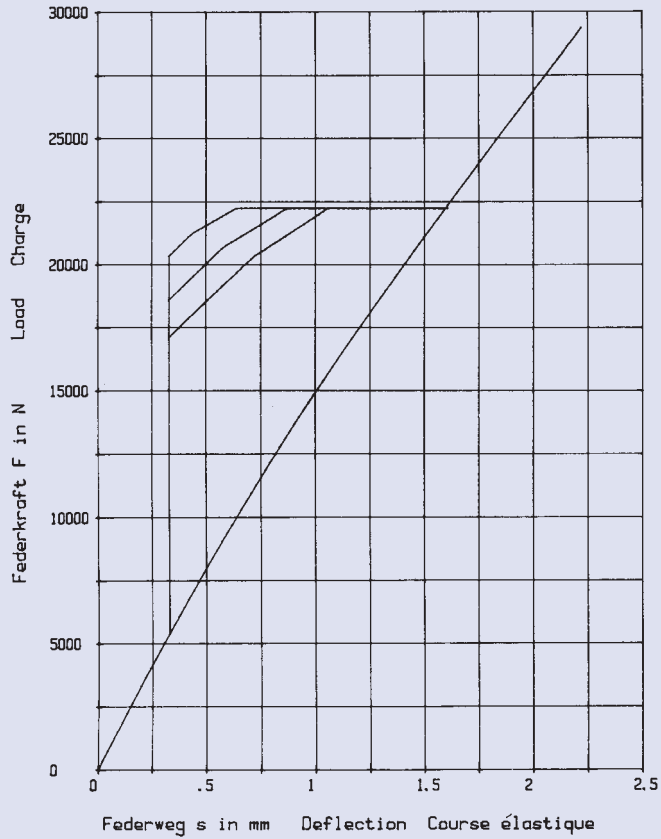
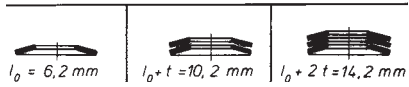

80 x 41 x 5,0

GR 2, DIN 2093 – A 80

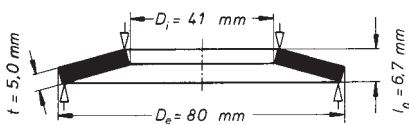

$h_0 = 1,7 \text{ mm}$        $D_e / D_i = 1,951$   
 $t = 5,0 \text{ mm}$        $D_e / t = 16$   
 $h_0 / t = 0,34$        $m = 145,468 \text{ g}$

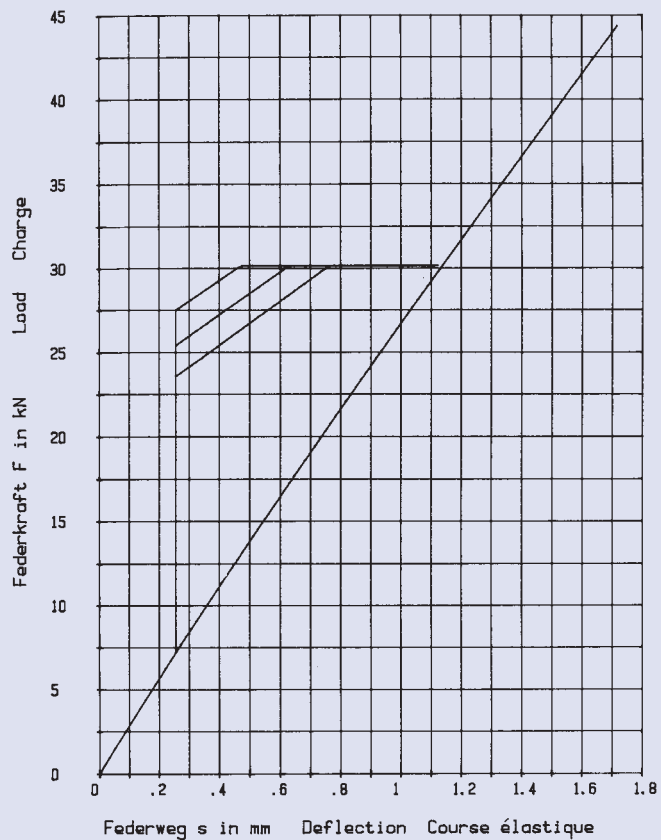
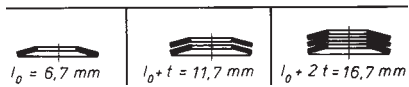

90 x 46 x 2,5

GR 2, DIN 2093 – C 90

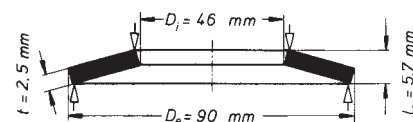
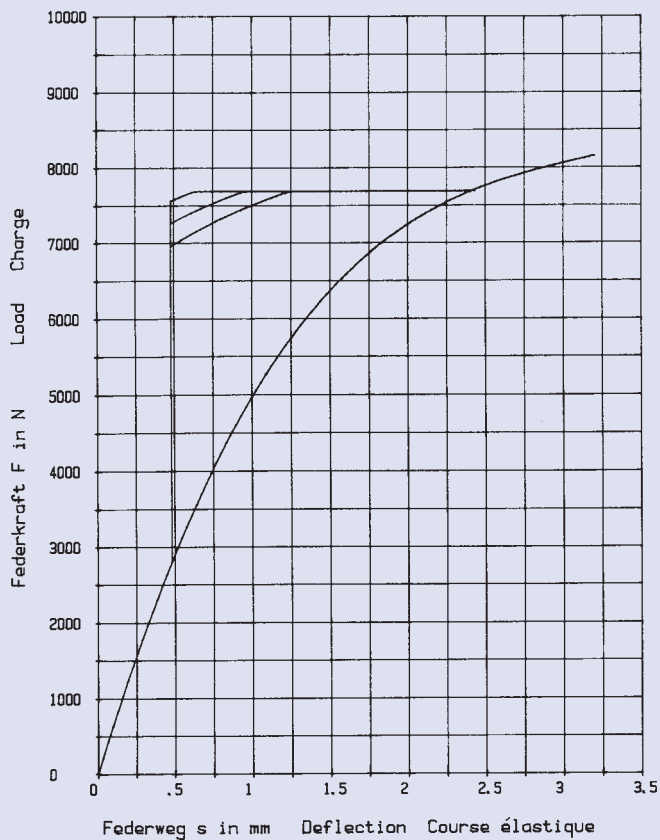

$h_0 = 3,2 \text{ mm}$        $D_e/D_i = 1,956$   
 $t = 2,5 \text{ mm}$        $D_e/t = 36$   
 $h_0/t = 1,28$        $m = 92,231 \text{ g}$

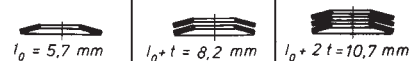

90 x 46 x 3,5

GR 2, DIN 2093 – B 90

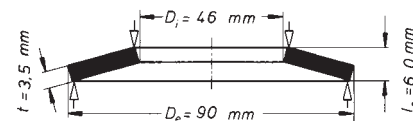
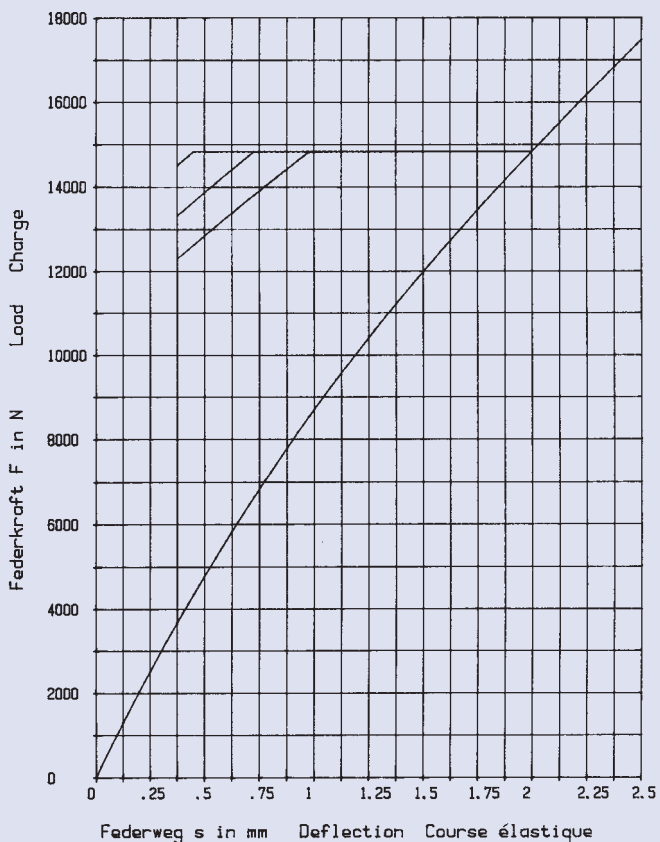

$h_0 = 2,5 \text{ mm}$        $D_e/D_i = 1,956$   
 $t = 3,5 \text{ mm}$        $D_e/t = 25,714$   
 $h_0/t = 0,714$        $m = 129,124 \text{ g}$

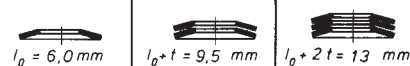

90 x 46 x 5,0

GR 2, DIN 2093 – A 90

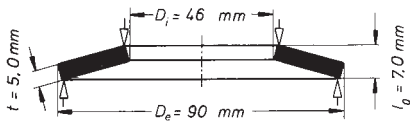

$h_0 = 2,0 \text{ mm}$        $D_e/D_i = 1,956$   
 $t = 5,0 \text{ mm}$        $D_e/t = 18$   
 $h_0/t = 0,4$        $m = 184,463 \text{ g}$

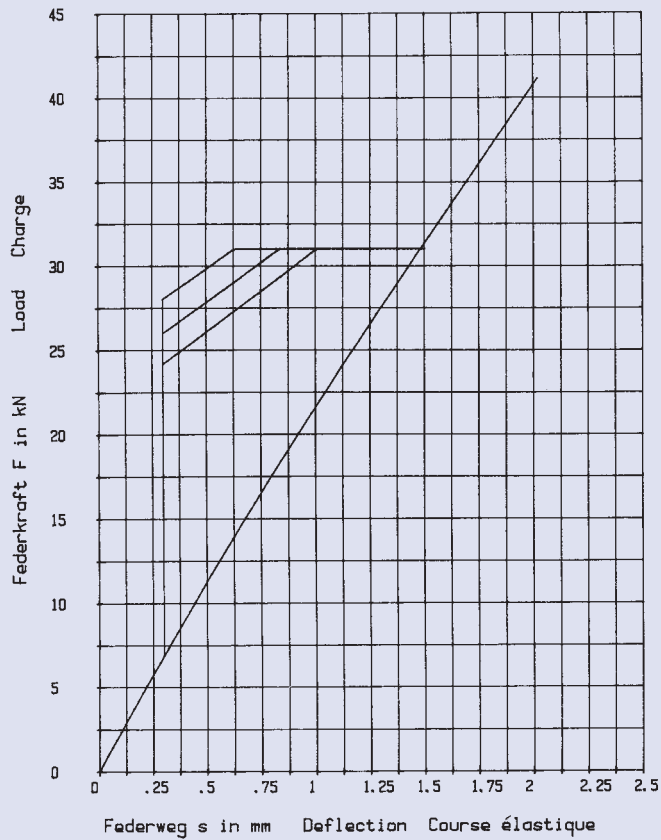
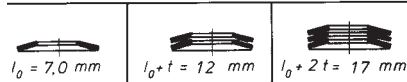

100 x 41 x 4,0

GR 2

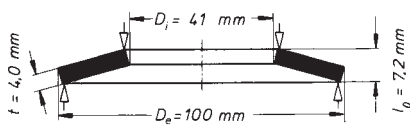

$h_0 = 3,2 \text{ mm}$        $D_e/D_i = 2,439$   
 $t = 4,0 \text{ mm}$        $D_e/t = 25$   
 $h_0/t = 0,8$        $m = 205,153 \text{ g}$

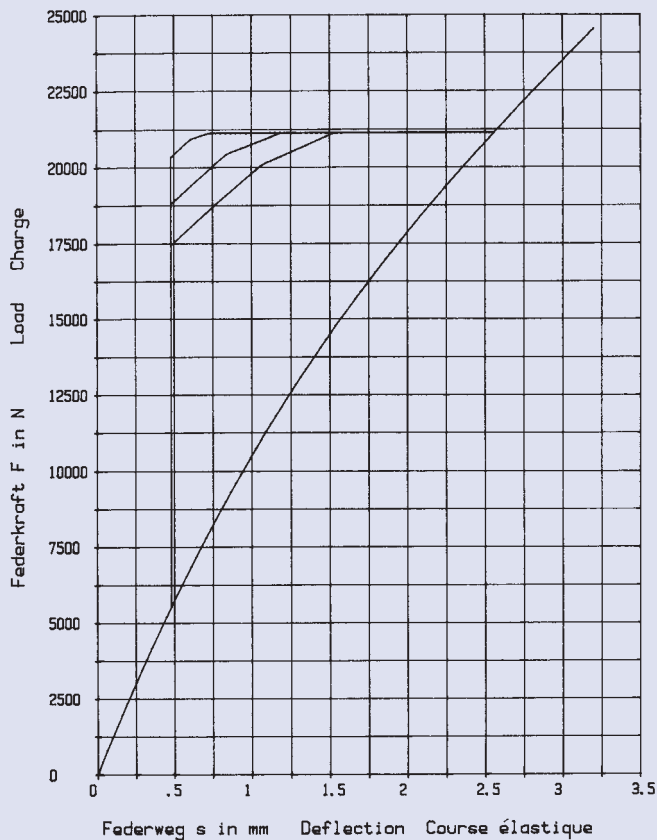
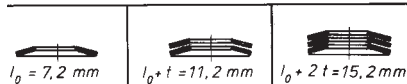

100 x 41 x 5,0

GR 2

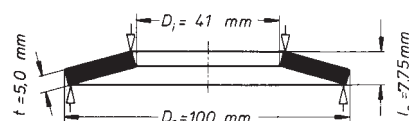

$h_0 = 2,75 \text{ mm}$        $D_e/D_i = 2,439$   
 $t = 5,0 \text{ mm}$        $D_e/t = 20$   
 $h_0/t = 0,55$        $m = 256,441 \text{ g}$

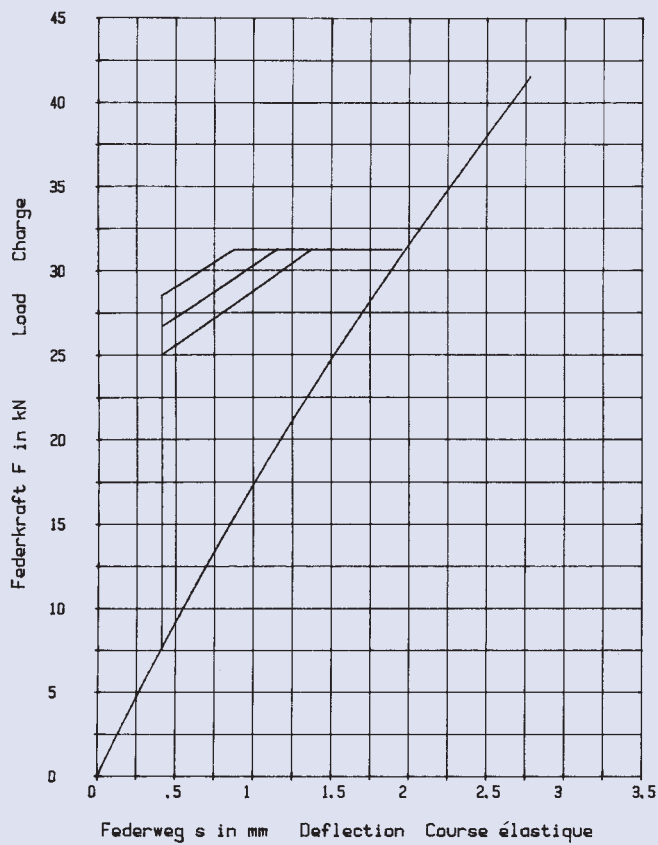
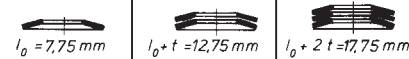

100 x 51 x 2,7

GR 2, DIN 2093 – C 100

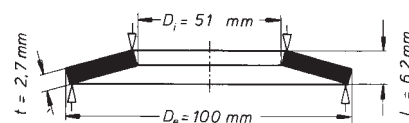

$h_0 = 3,5 \text{ mm}$        $D_e/D_i = 1,96$   
 $t = 2,7 \text{ mm}$        $D_e/t = 37,037$   
 $h_0/t = 1,296$        $m = 123,164 \text{ g}$

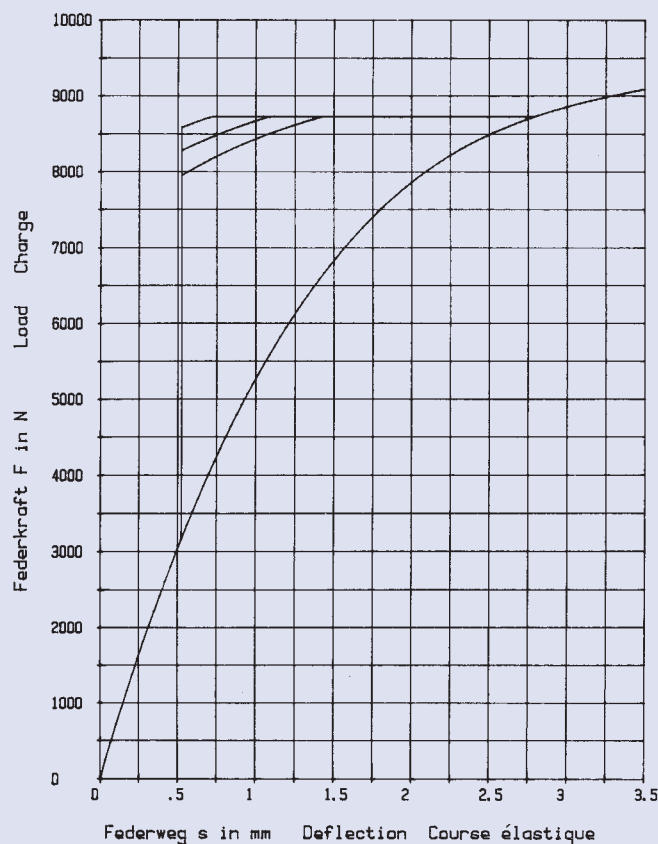
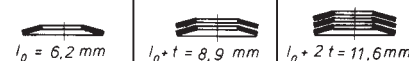

100 x 51 x 3,5

GR 2, DIN 2093 – B 100

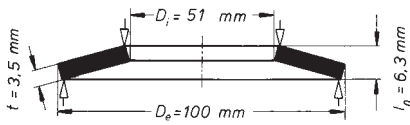

$h_0 = 2.8 \text{ mm}$        $D_e / D_i = 1.96$   
 $t = 3.5 \text{ mm}$        $D_e / t = 28.571$   
 $h_0 / t = 0.8$        $m = 159.657 \text{ g}$

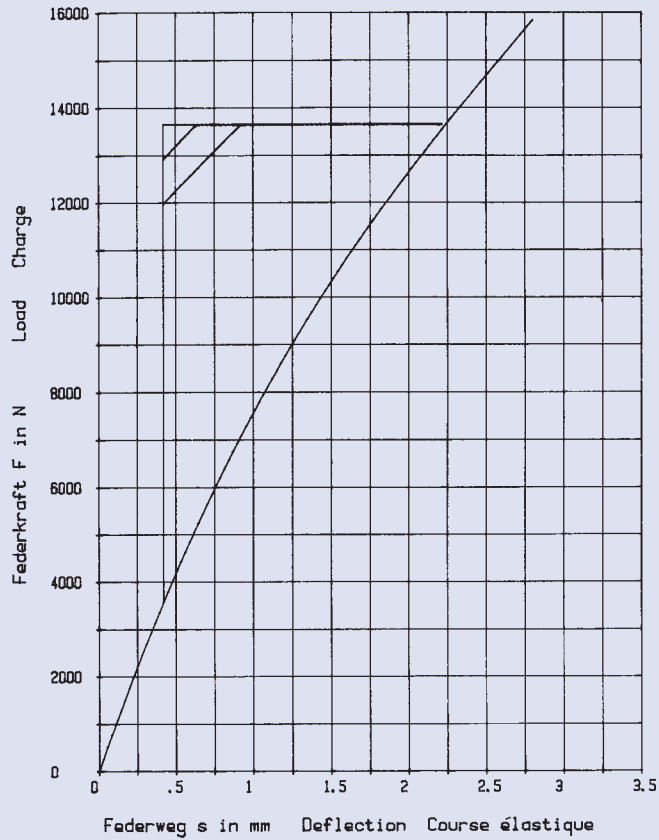
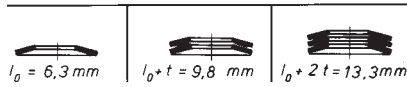

100 x 51 x 4,0

GR 2

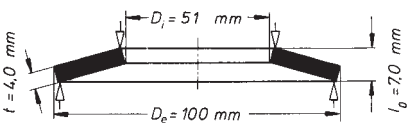

$h_0 = 3.0 \text{ mm}$        $D_e / D_i = 1.96$   
 $t = 4.0 \text{ mm}$        $D_e / t = 25$   
 $h_0 / t = 0.75$        $m = 182.465 \text{ g}$

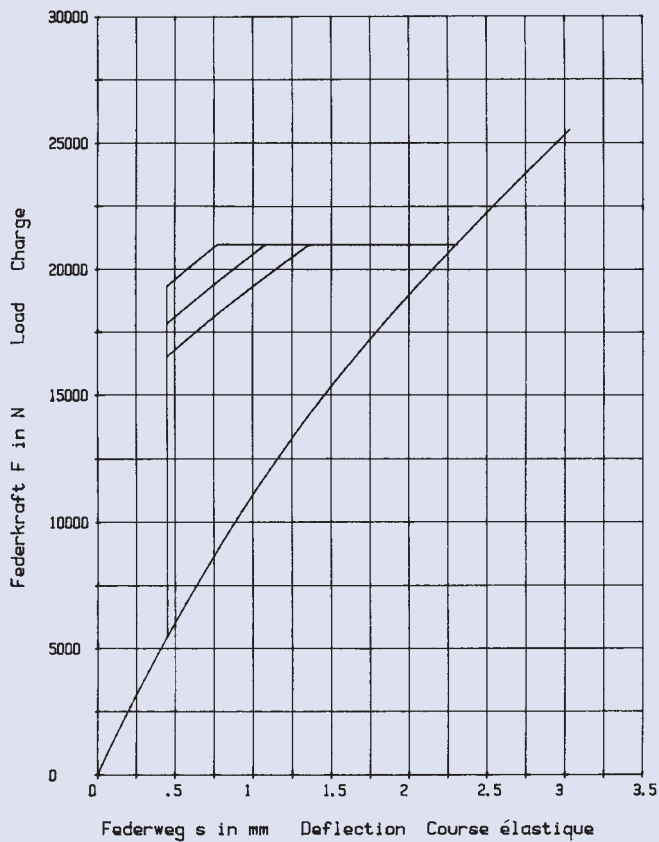
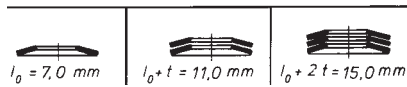

100 x 51 x 5,0

GR 2

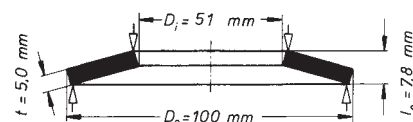
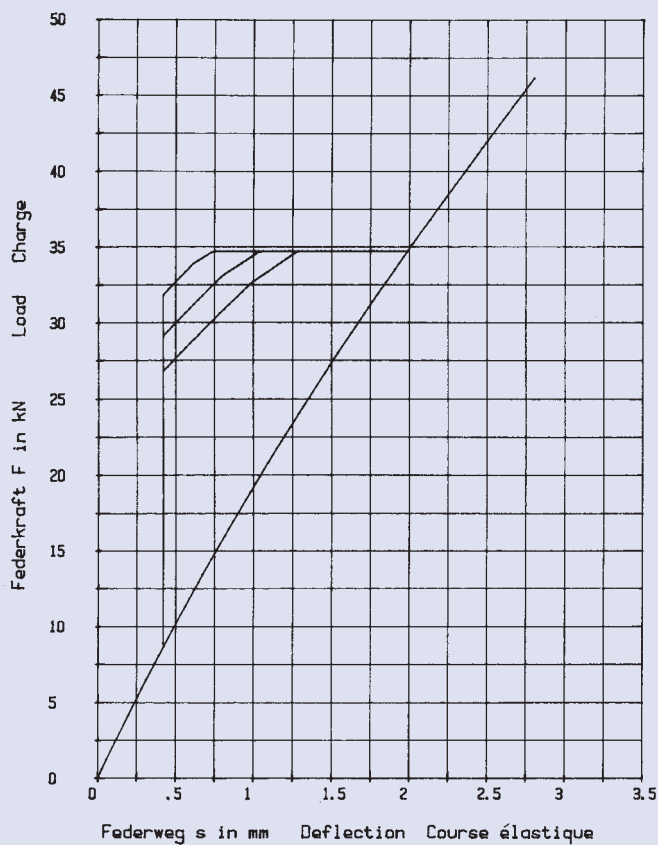

$h_0 = 2,8 \text{ mm}$        $D_e/D_i = 1,96$   
 $t = 5,0 \text{ mm}$        $D_e/t = 20$   
 $h_0/t = 0,56$        $m = 228,081 \text{ g}$

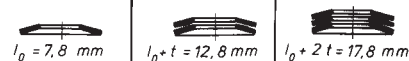

100 x 51 x 6,0

GR 2, DIN 2093 – A 100

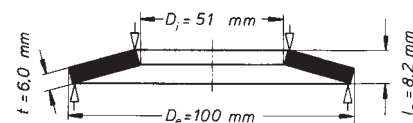
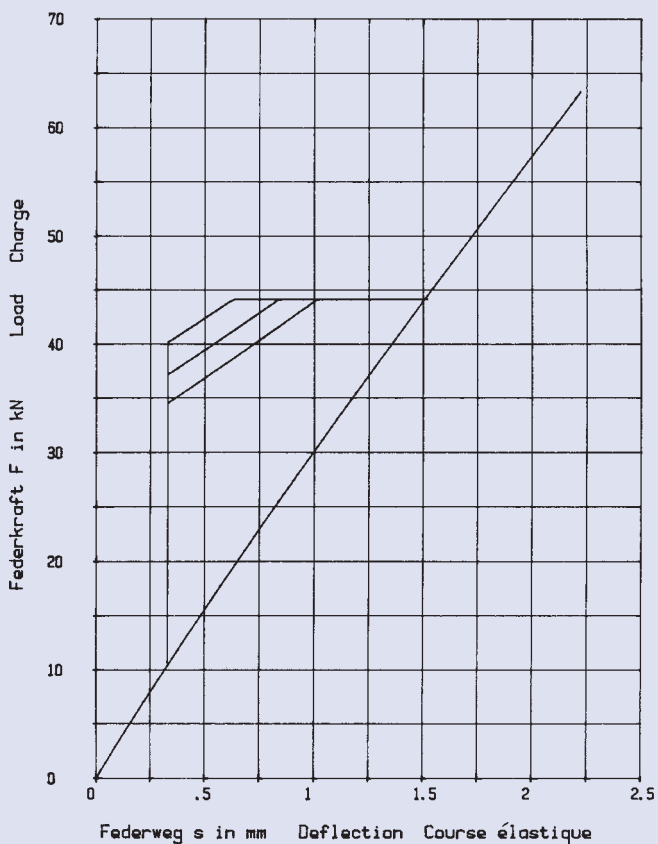

$h_0 = 2,2 \text{ mm}$        $D_e/D_i = 1,96$   
 $t = 6,0 \text{ mm}$        $D_e/t = 16,666$   
 $h_0/t = 0,366$        $m = 273,698 \text{ g}$

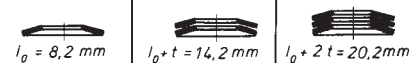

100 x 51 x 7,0

GR 3

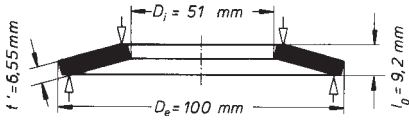

$h_0 = 2,2 \text{ mm}$      $D_e / D_i = 1,96$      $h'_0 = 2,65 \text{ mm}$   
 $t = 7,0 \text{ mm}$      $D_e / t = 14,285$      $t' / t = 0,935$   
 $h_0 / t = 0,314$      $m = 298,79 \text{ g}$      $h'_0 / t' = 0,405$

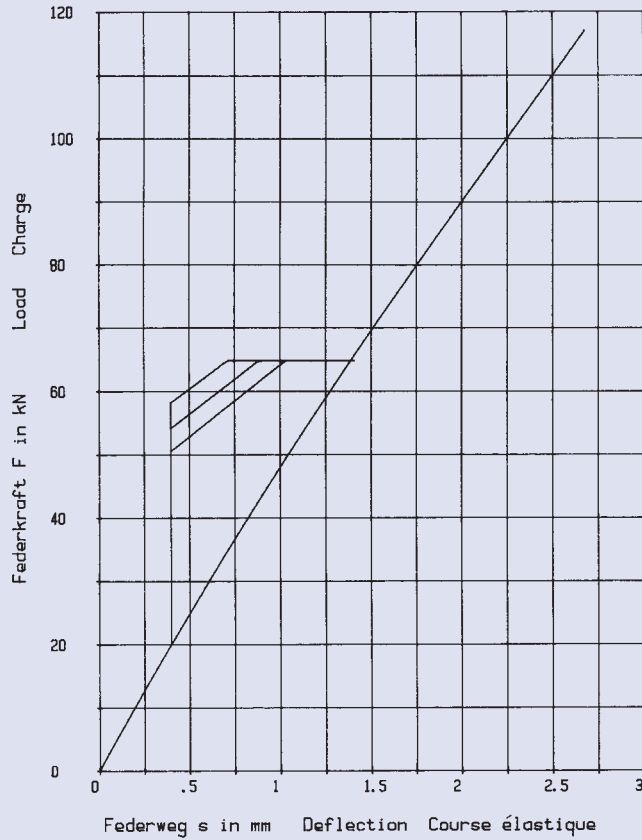
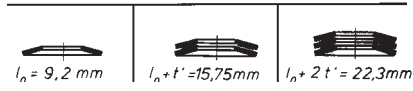

112 x 57 x 3,0

GR 2, DIN 2093 – C 112

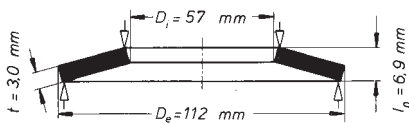

$h_0 = 3,9 \text{ mm}$      $D_e / D_i = 1,964$   
 $t = 3,0 \text{ mm}$      $D_e / t = 37,333$   
 $h_0 / t = 1,3$      $m = 171,917 \text{ g}$

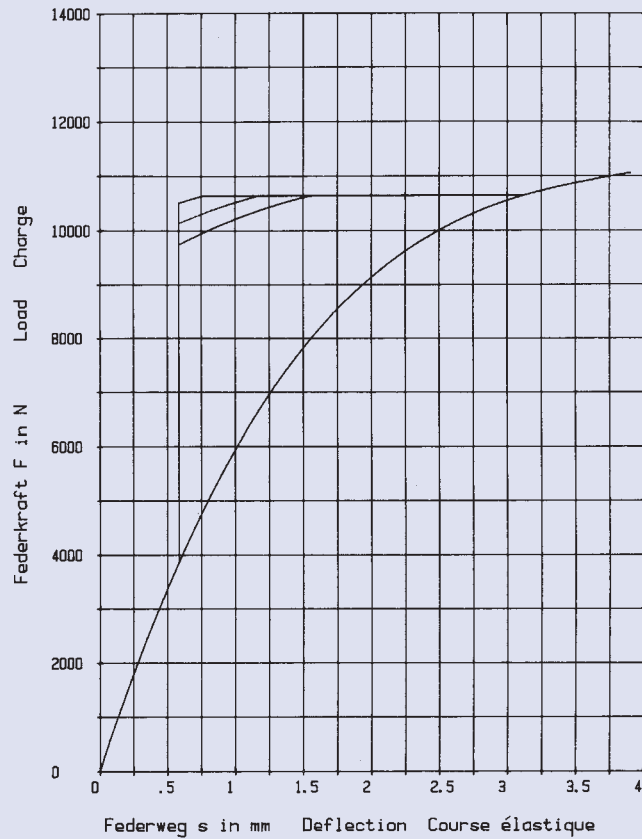
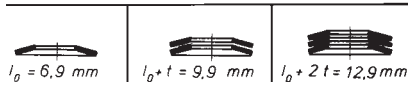



112 x 57 x 4,0

GR 2, DIN 2093 – B 112

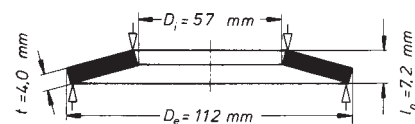

$h_0 = 3,2 \text{ mm}$        $D_e/D_i = 1,964$   
 $t = 4,0 \text{ mm}$        $D_e/t = 28$   
 $h_0/t = 0,8$        $m = 229,222 \text{ g}$

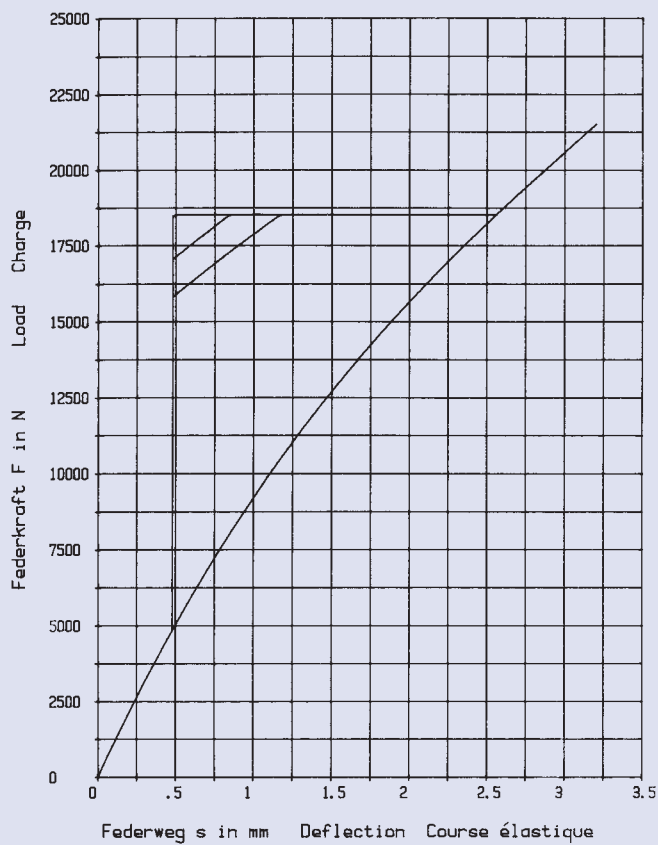
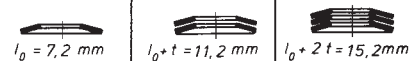

112 x 57 x 6,0

GR 2, DIN 2093 – A 112

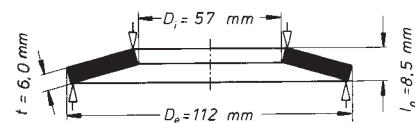

$h_0 = 2,5 \text{ mm}$        $D_e/D_i = 1,964$   
 $t = 6,0 \text{ mm}$        $D_e/t = 18,666$   
 $h_0/t = 0,416$        $m = 343,833 \text{ g}$

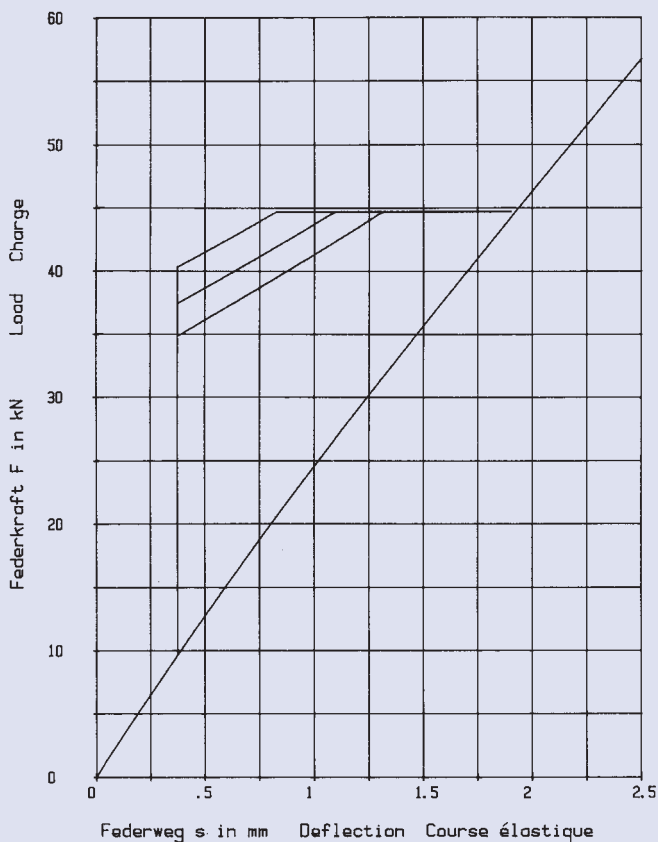
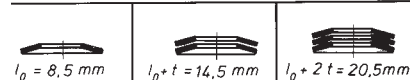

125 x 51 x 4,0

GR 2

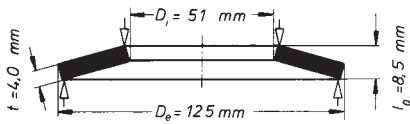

$h_0 = 4,5 \text{ mm}$        $D_e/D_i = 2,45$   
 $t = 4,0 \text{ mm}$        $D_e/t = 31,25$   
 $h_0/t = 1,125$        $m = 321,18 \text{ g}$

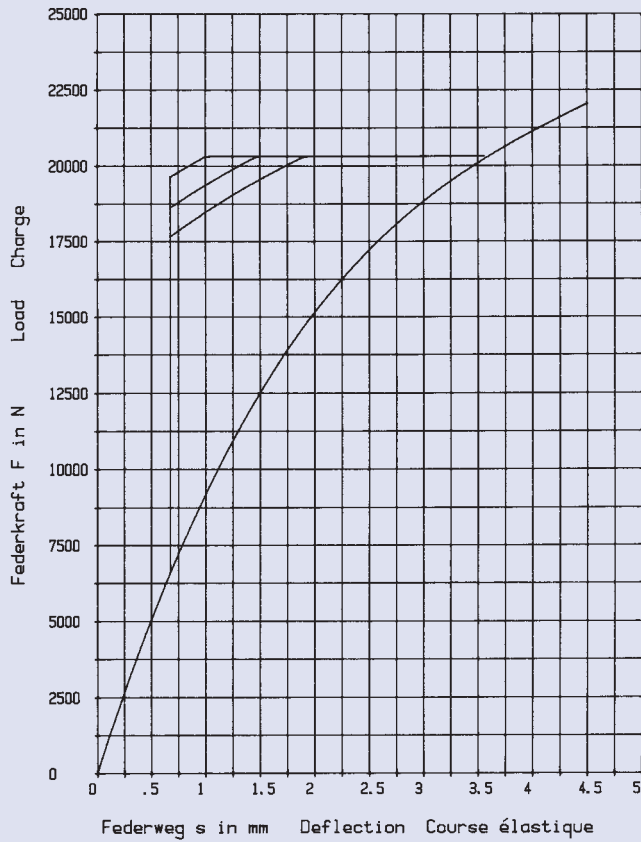
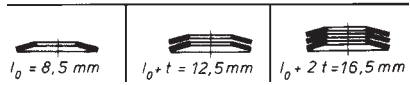

125 x 51 x 5,0

GR 2

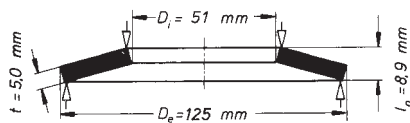

$h_0 = 3,9 \text{ mm}$        $D_e/D_i = 2,45$   
 $t = 5,0 \text{ mm}$        $D_e/t = 25$   
 $h_0/t = 0,78$        $m = 401,478 \text{ g}$

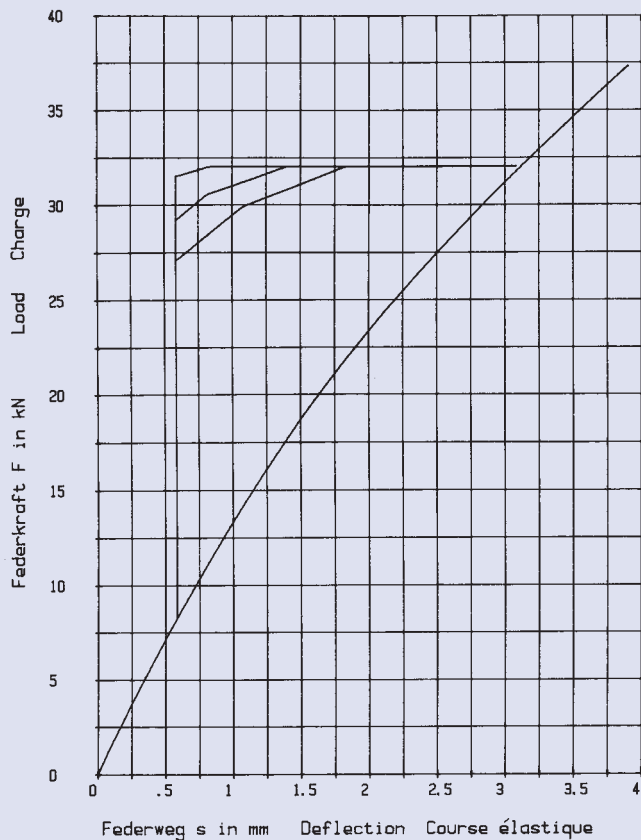
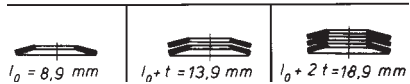

125 x 51 x 6,0

GR 2

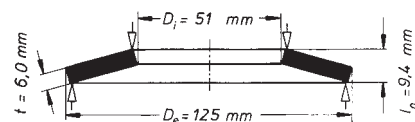
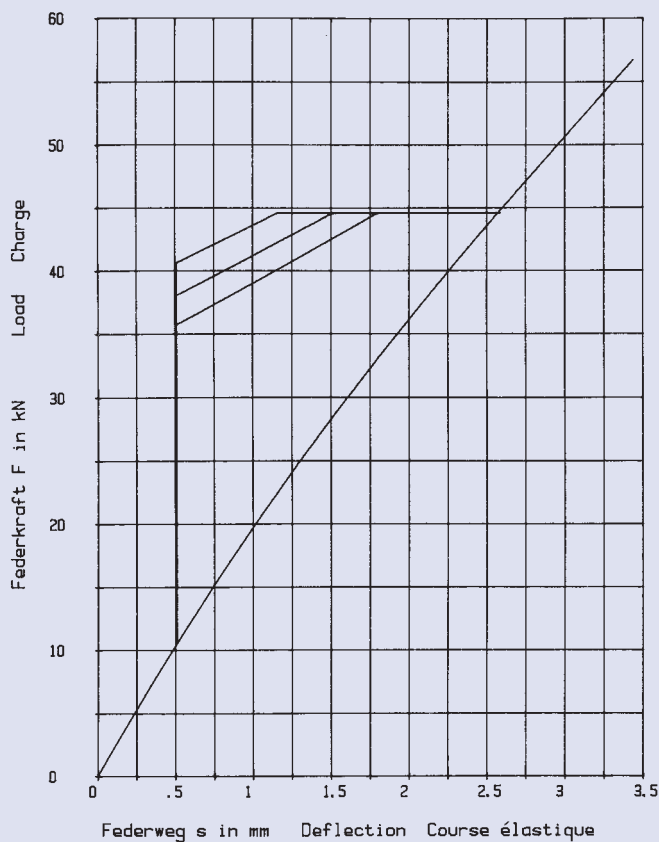

$h_0 = 3,4 \text{ mm}$        $D_e/D_i = 2,45$   
 $t = 6,0 \text{ mm}$        $D_e/t = 20,833$   
 $h_0/t = 0,566$        $m = 481,773 \text{ g}$

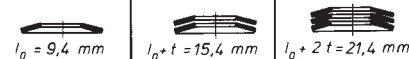

125 x 61 x 5,0

GR 2

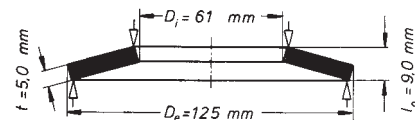
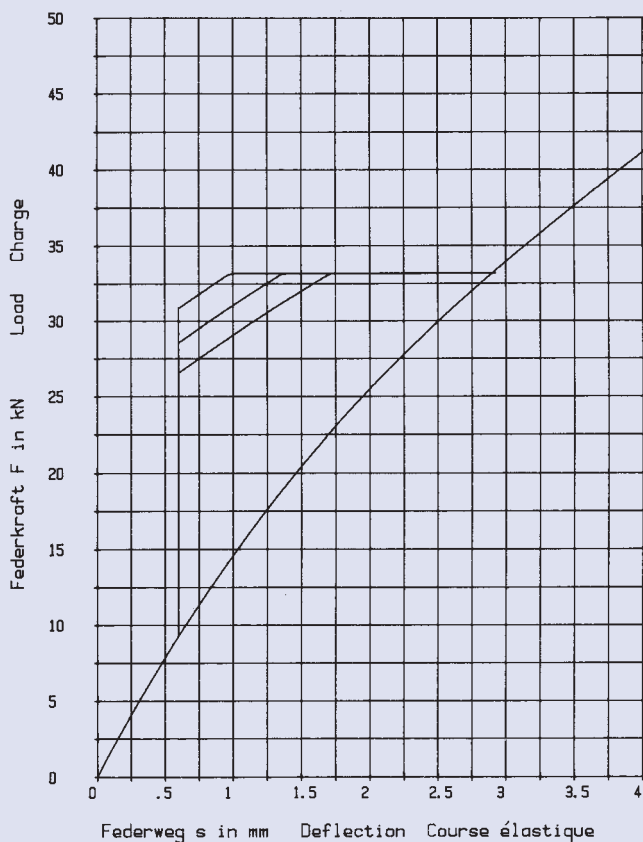

$h_0 = 4,0 \text{ mm}$        $D_e/D_i = 2,049$   
 $t = 5,0 \text{ mm}$        $D_e/t = 25$   
 $h_0/t = 0,8$        $m = 366,953 \text{ g}$

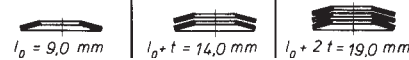

125 x 61 x 6,0

GR 2

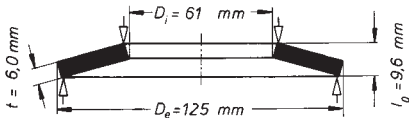

$h_0 = 3,6 \text{ mm}$        $D_e / D_i = 2,049$   
 $t = 6,0 \text{ mm}$        $D_e / t = 20,833$   
 $h_0 / t = 0,6$        $m = 440,343 \text{ g}$

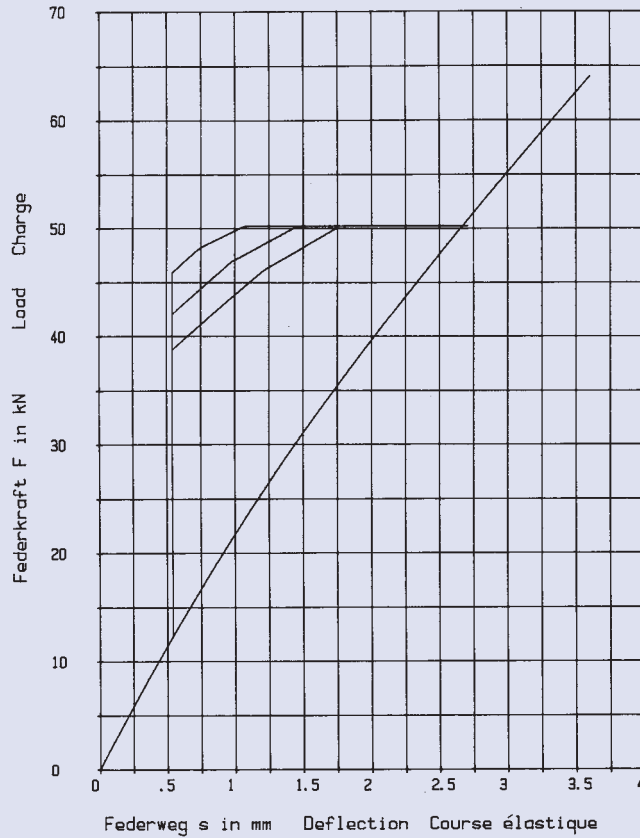
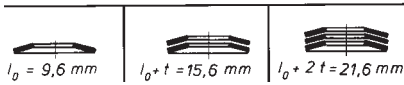

125 x 61 x 8,0

GR 3

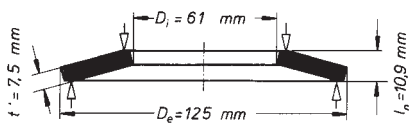

$h_0 = 2,9 \text{ mm}$        $D_e / D_i = 2,049$        $h'_0 = 3,4 \text{ mm}$   
 $t = 8,0 \text{ mm}$        $D_e / t = 15,625$        $t' / t = 0,937$   
 $h_0 / t = 0,362$        $m = 550,43 \text{ g}$        $h'_0 / t' = 0,453$

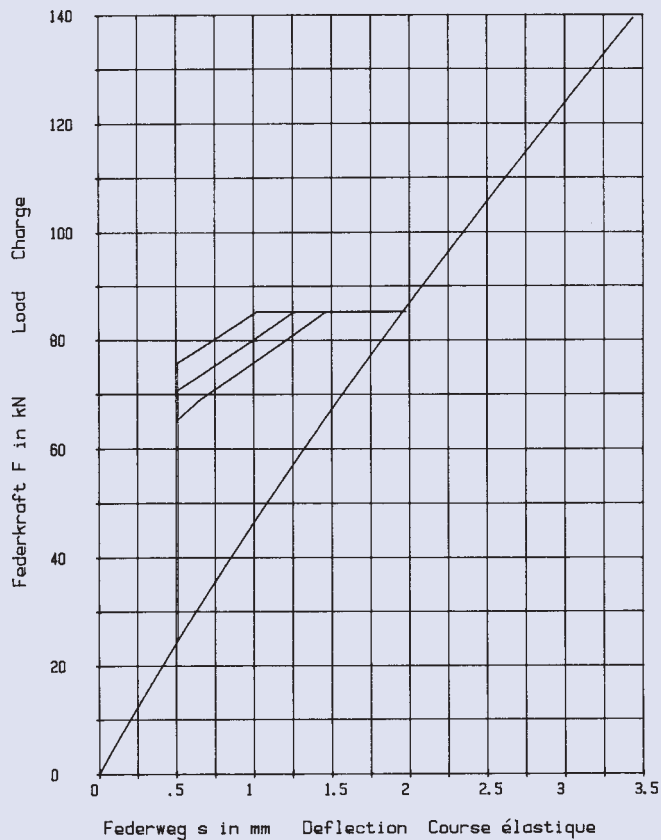
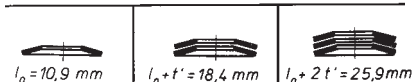

125 x 64 x 3,5

GR 2, DIN 2093 – C 125

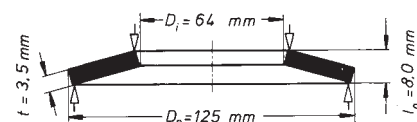
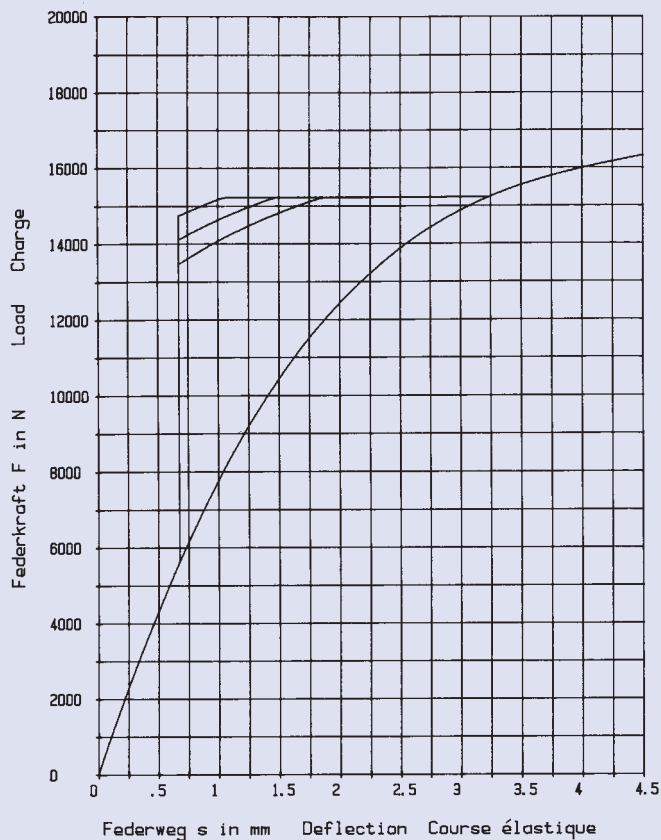

$h_0 = 4,5 \text{ mm}$        $D_e/D_i = 1,953$   
 $t = 3,5 \text{ mm}$        $D_e/t = 35,714$   
 $h_0/t = 1,285$        $m = 248,775 \text{ g}$

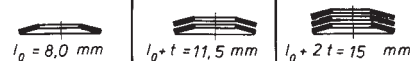

125 x 64 x 5,0

GR 2, DIN 2093 – B 125

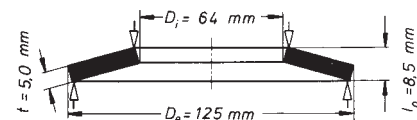
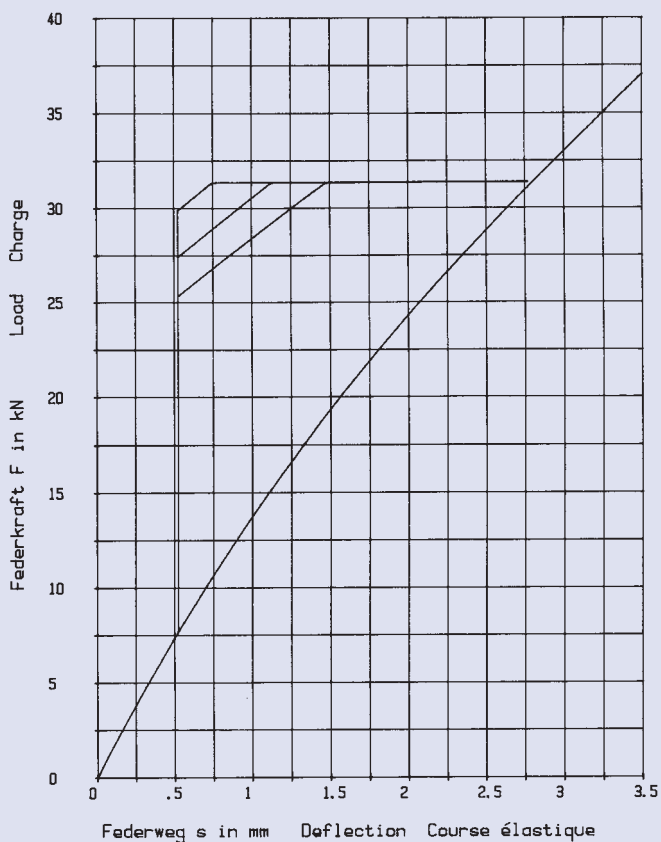

$h_0 = 3,5 \text{ mm}$        $D_e/D_i = 1,953$   
 $t = 5,0 \text{ mm}$        $D_e/t = 25$   
 $h_0/t = 0,7$        $m = 355,393 \text{ g}$

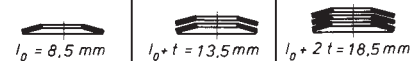

125 x 64 x 6,0

GR 2

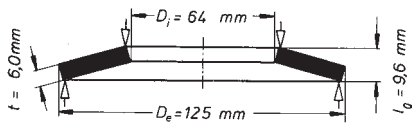

$h_0 = 3,6 \text{ mm}$        $D_e / D_i = 1,953$   
 $t = 6,0 \text{ mm}$        $D_e / t = 20,833$   
 $h_0 / t = 0,6$        $m = 426,471 \text{ g}$

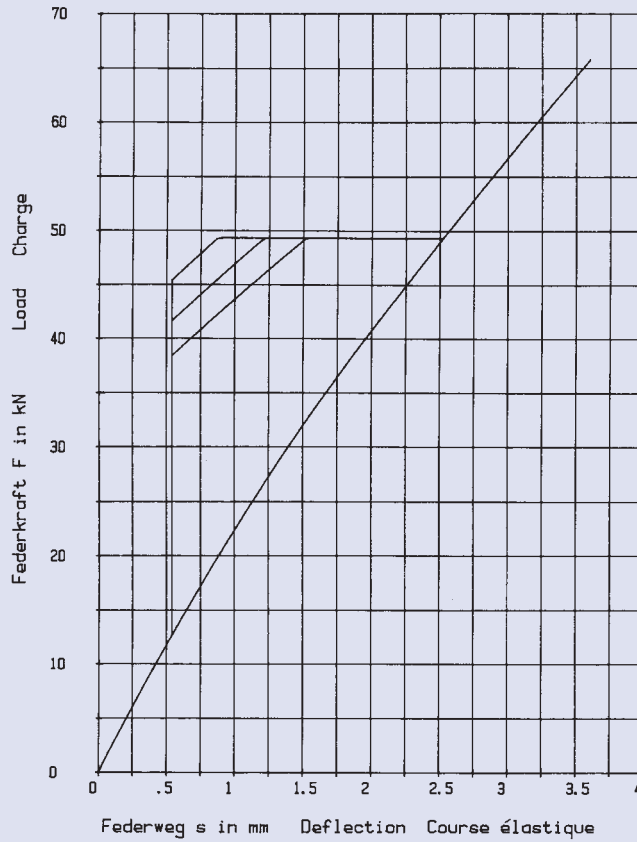
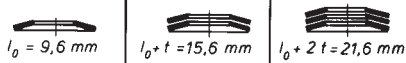

125 x 64 x 7,0

GR 3

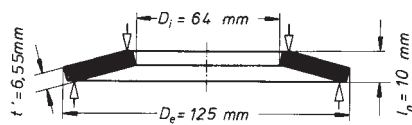

$h_0 = 3,0 \text{ mm}$        $D_e / D_i = 1,953$        $h'_0 = 3,45 \text{ mm}$   
 $t = 7,0 \text{ mm}$        $D_e / t = 17,857$        $t' / t = 0,935$   
 $h_0 / t = 0,428$        $m = 465,56 \text{ g}$        $h'_0 / t' = 0,527$

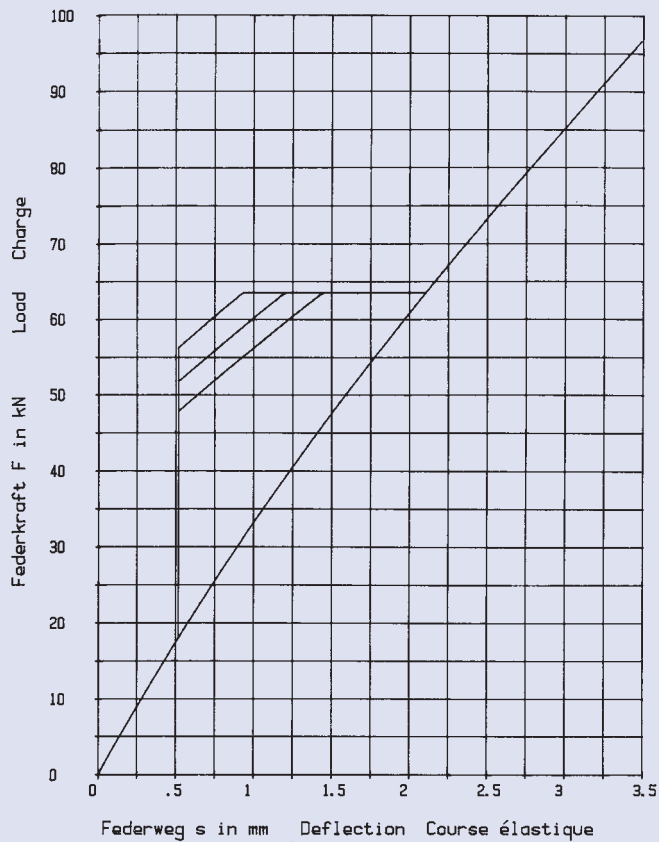
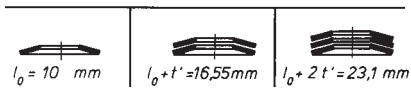

125 x 64 x 8,0

GR 3, DIN 2093 – A 125

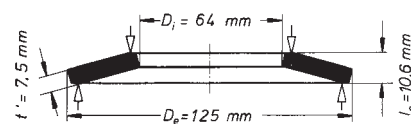

$h_0 = 2,6 \text{ mm}$       $D_e / D_i = 1,953$       $h'_0 = 3,1 \text{ mm}$   
 $t = 8,0 \text{ mm}$       $D_e / t = 15,625$       $t' / t = 0,937$   
 $h_0 / t = 0,325$       $m = 533,089 \text{ g}$       $h'_0 / t' = 0,413$

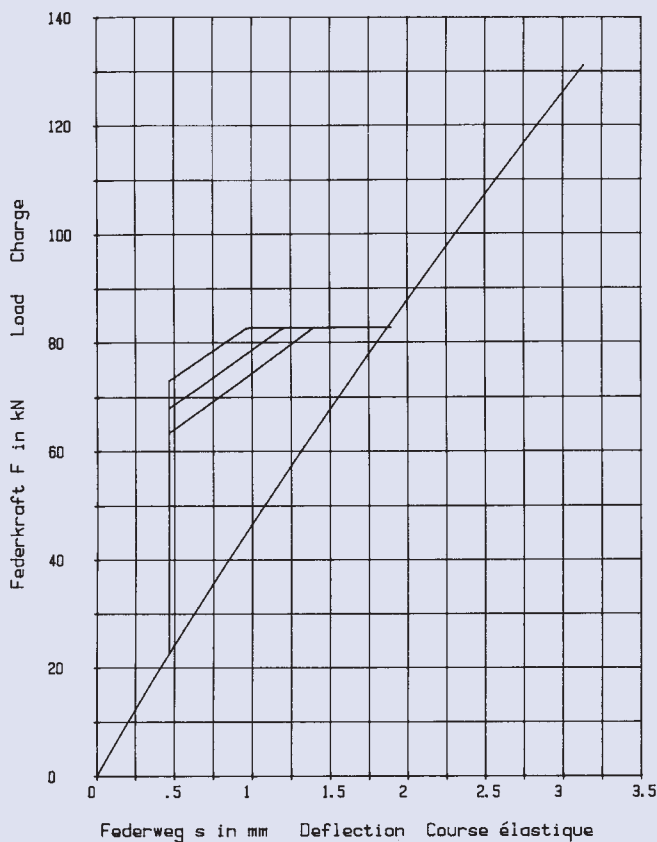
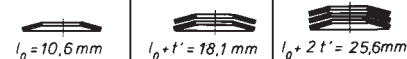

125 x 71 x 6,0

GR 2

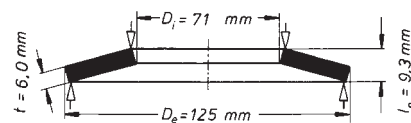

$h_0 = 3,3 \text{ mm}$       $D_e / D_i = 1,76$   
 $t = 6,0 \text{ mm}$       $D_e / t = 20,833$   
 $h_0 / t = 0,55$       $m = 391,515 \text{ g}$

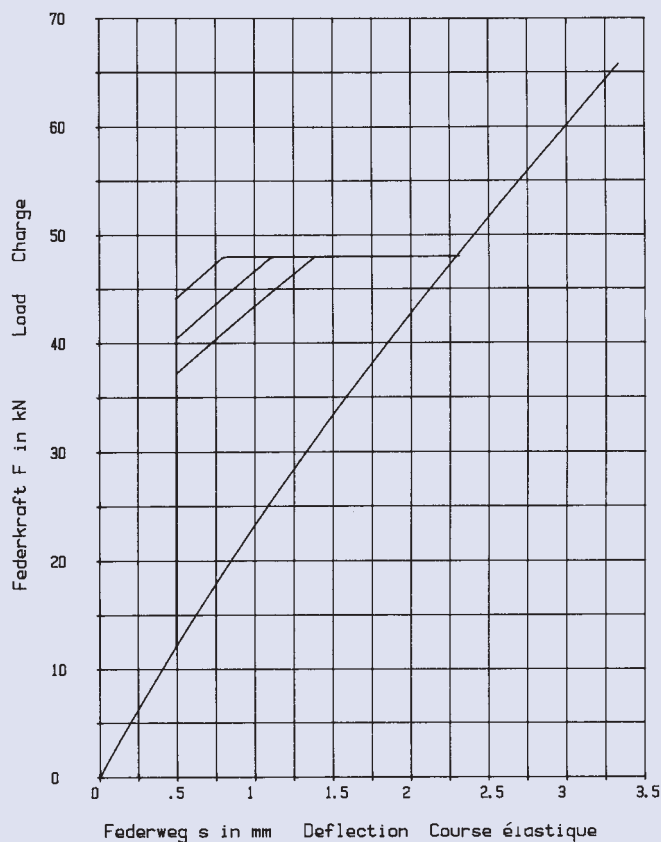
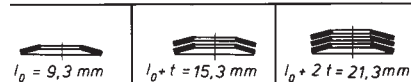

125 x 71 x 8,0

GR 3

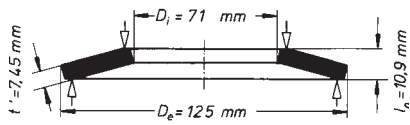

$t = 2,9 \text{ mm}$      $D_e / D_i = 1,76$      $h'_0 = 3,45 \text{ mm}$   
 $t = 8,0 \text{ mm}$      $D_e / t = 15,625$      $t' / t = 0,931$   
 $l_0 / t = 0,362$      $m = 486,13 \text{ g}$      $h'_0 / t' = 0,463$

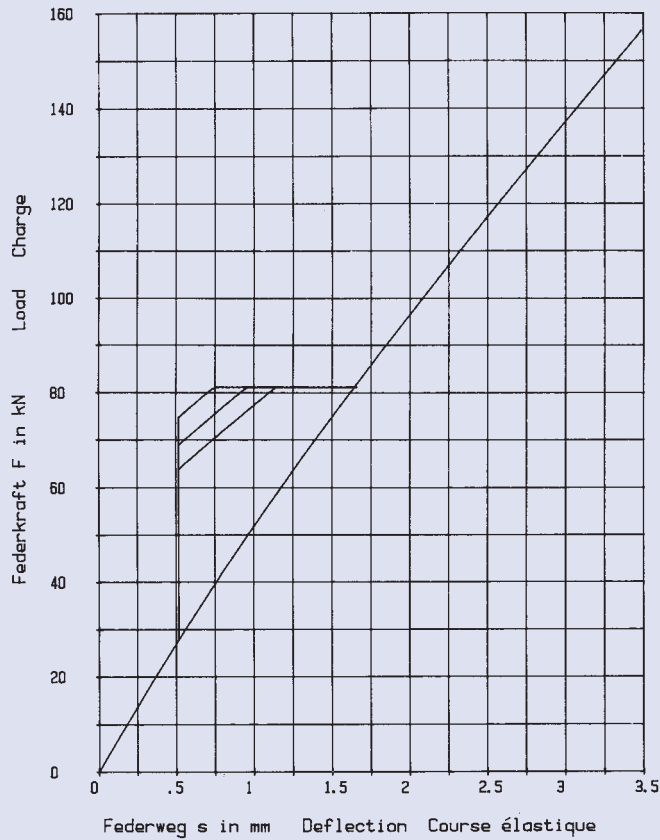
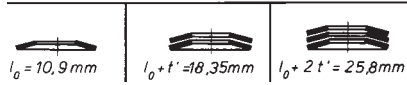

125 x 71 x 10

GR 3

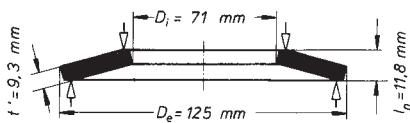

$t = 1,8 \text{ mm}$      $D_e / D_i = 1,76$      $h'_0 = 2,5 \text{ mm}$   
 $t = 10 \text{ mm}$      $D_e / t = 12,5$      $t' / t = 0,93$   
 $l_0 / t = 0,18$      $m = 606,85 \text{ g}$      $h'_0 / t' = 0,269$

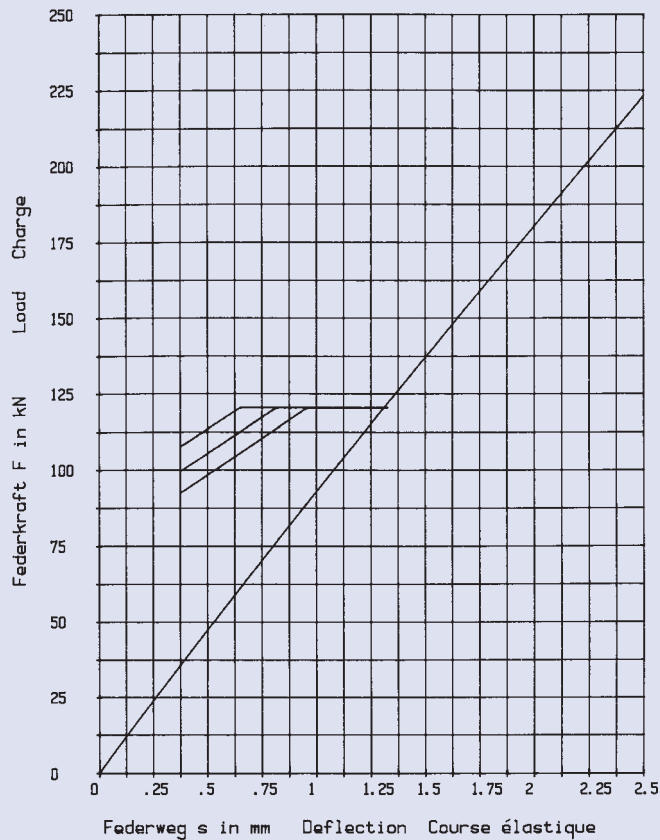
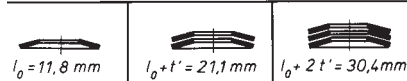



140 x 72 x 3,8

GR 2, DIN 2093 – C 140

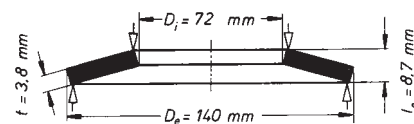
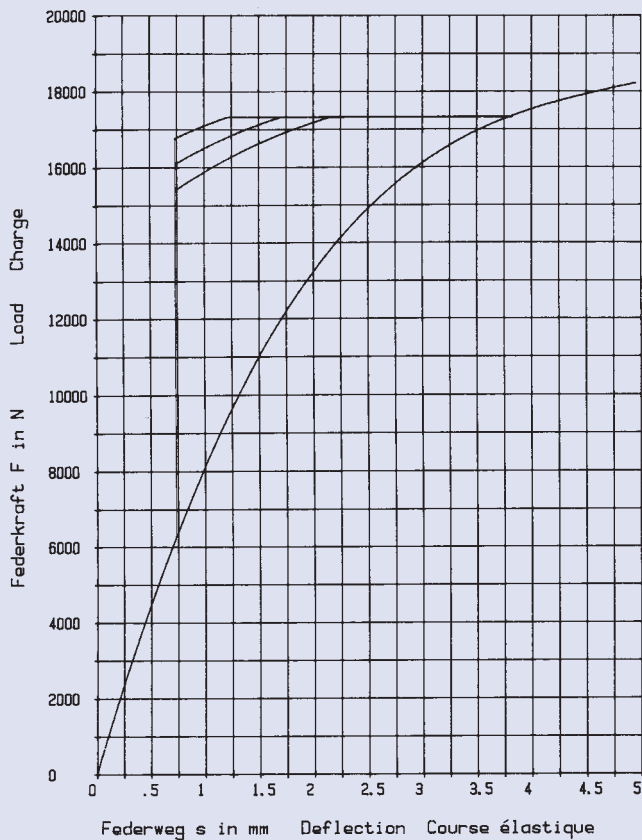

$h_0 = 4,9 \text{ mm}$        $D_e/D_i = 1,944$   
 $t = 3,8 \text{ mm}$        $D_e/t = 36,842$   
 $h_0/t = 1,289$        $m = 337,734 \text{ g}$



140 x 72 x 5,0

GR 2, DIN 2093 – B 140

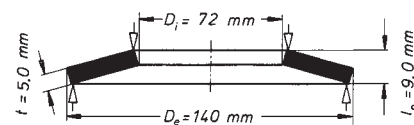
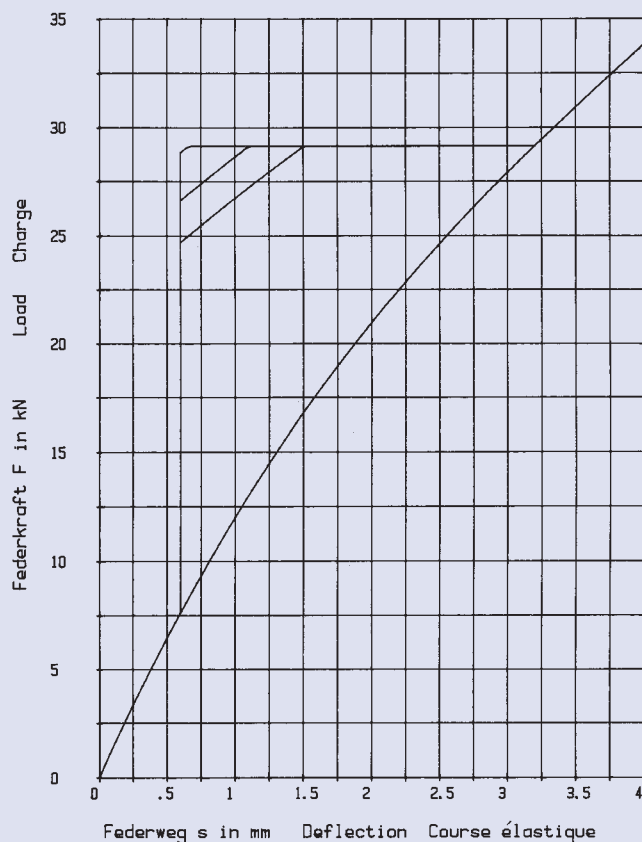

$h_0 = 4,0 \text{ mm}$        $D_e/D_i = 1,944$   
 $t = 5,0 \text{ mm}$        $D_e/t = 28$   
 $h_0/t = 0,8$        $m = 444,388 \text{ g}$

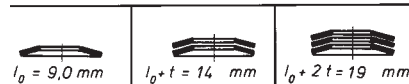

140 x 72 x 8,0

GR 3, DIN 2093 – A 140

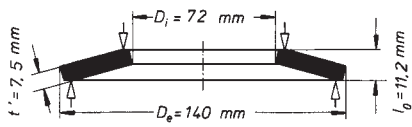

$h_0 = 3,2 \text{ mm}$       $D_e / D_i = 1,944$       $h_0' = 3,7 \text{ mm}$   
 $t = 8,0 \text{ mm}$       $D_e / t = 17,5$       $t' / t = 0,937$   
 $h_0 / t = 0,4$       $m = 666,581 \text{ g}$       $h_0' / t' = 0,493$

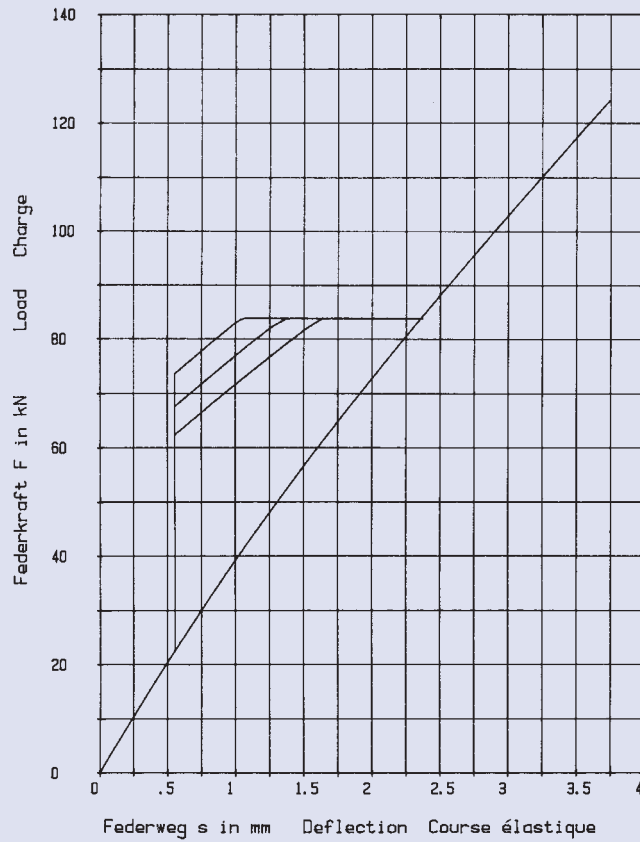
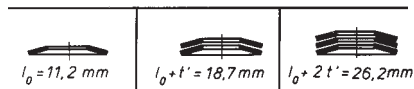

150 x 61 x 5,0

GR 2

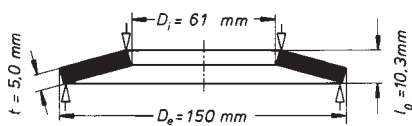

$h_0 = 5,3 \text{ mm}$       $D_e / D_i = 2,459$   
 $t = 5,0 \text{ mm}$       $D_e / t = 30$   
 $h_0 / t = 1,06$       $m = 578,881 \text{ g}$

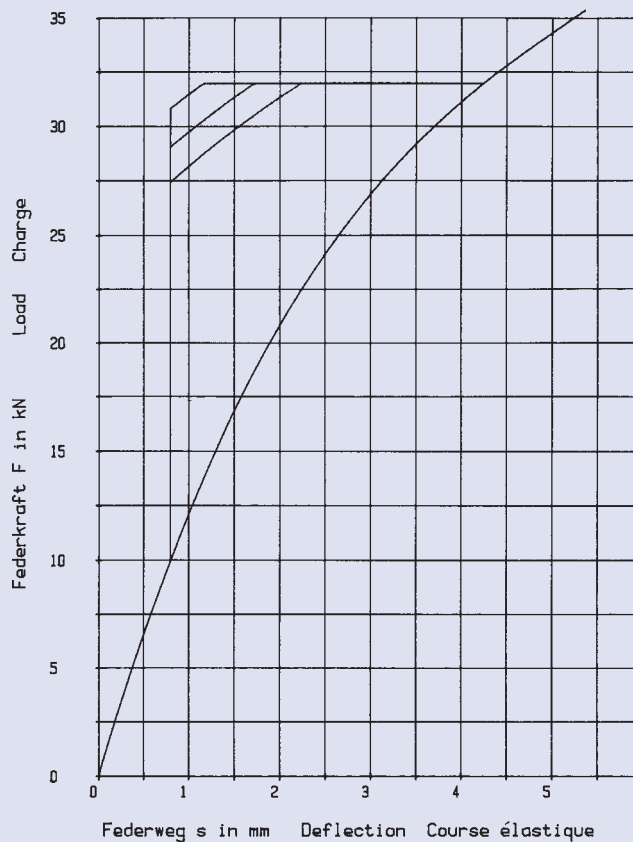
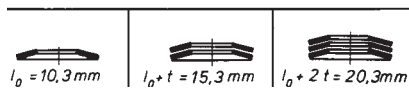

150 x 61 x 6,0

GR 2

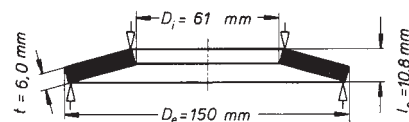
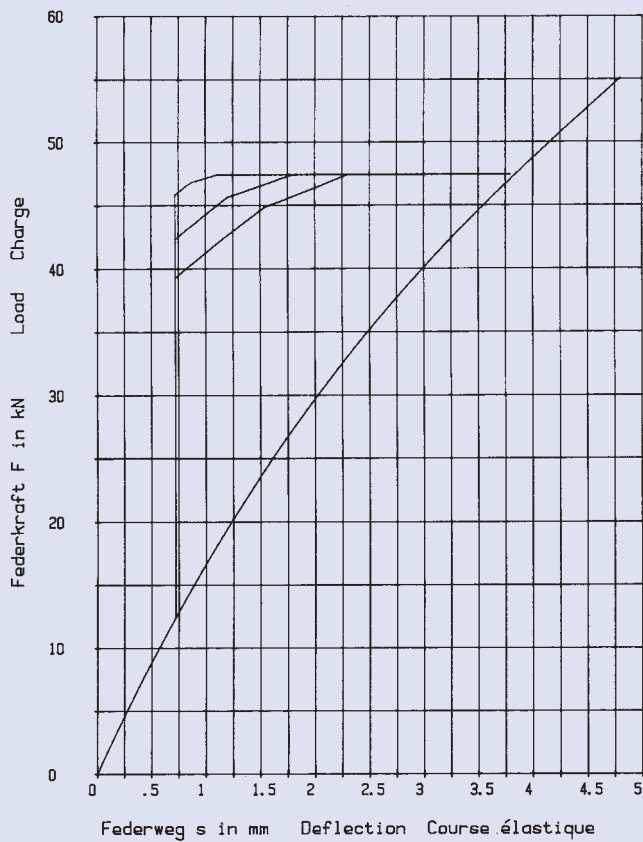

$h_0 = 4,8 \text{ mm}$        $D_e/D_i = 2,459$   
 $t = 6,0 \text{ mm}$        $D_e/t = 25$   
 $h_0/t = 0,8$        $m = 694,658 \text{ g}$

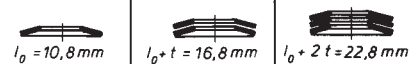

150 x 61 x 7,0

GR 3

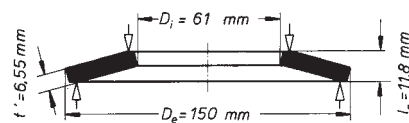
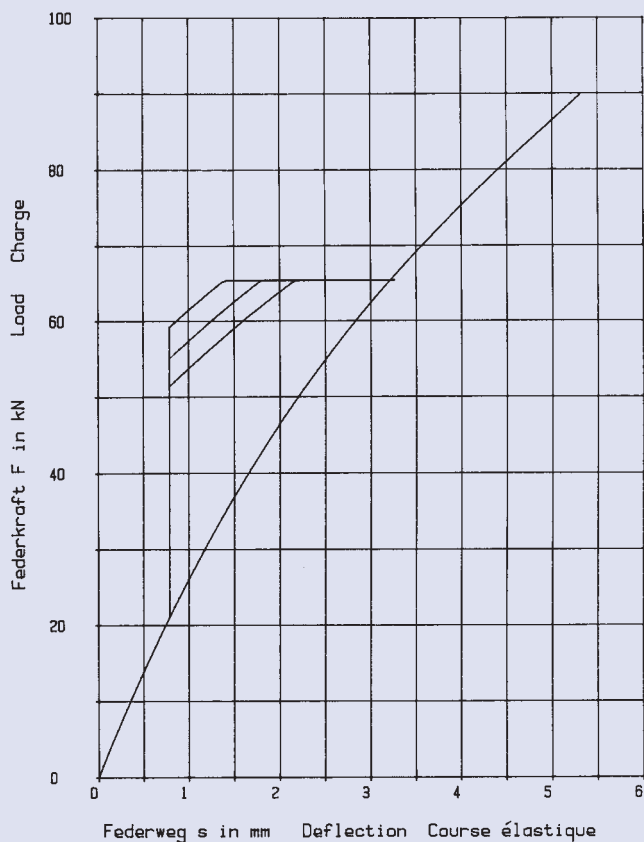

$h_0 = 4,8 \text{ mm}$        $D_e/D_i = 2,459$        $h_0' = 5,25 \text{ mm}$   
 $t = 7,0 \text{ mm}$        $D_e/t = 21,428$        $t'/t = 0,935$   
 $h_0/t = 0,685$        $m = 758,34 \text{ g}$        $h_0'/t' = 0,802$

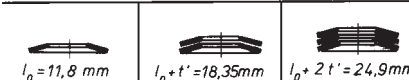

150 x 71 x 6,0

GR 2

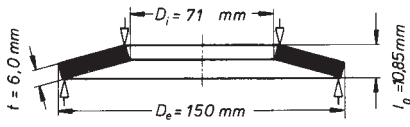

$h_0 = 4,85 \text{ mm}$        $D_e / D_i = 2,112$   
 $t = 6,0 \text{ mm}$        $D_e / t = 25$   
 $h_0 / t = 0,808$        $m = 645,829 \text{ g}$

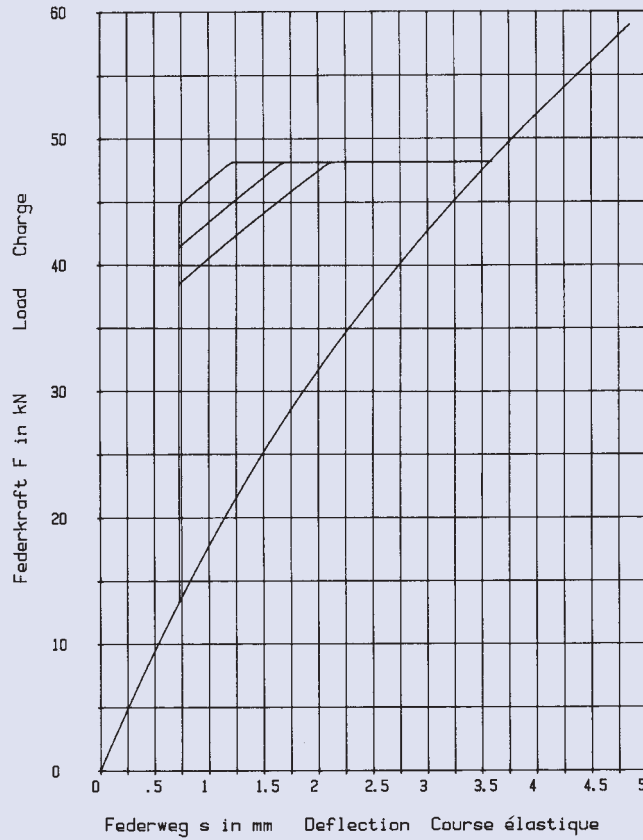
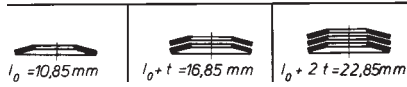

150 x 71 x 8,0

GR 3

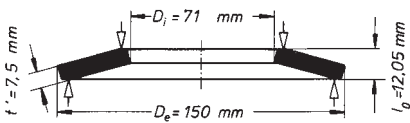

$h_0 = 4,05 \text{ mm}$        $D_e / D_i = 2,112$        $h_0' = 4,55 \text{ mm}$   
 $t = 8,0 \text{ mm}$        $D_e / t = 18,75$        $t' / t = 0,937$   
 $h_0 / t = 0,506$        $m = 807,29 \text{ g}$        $h_0' / t' = 0,607$

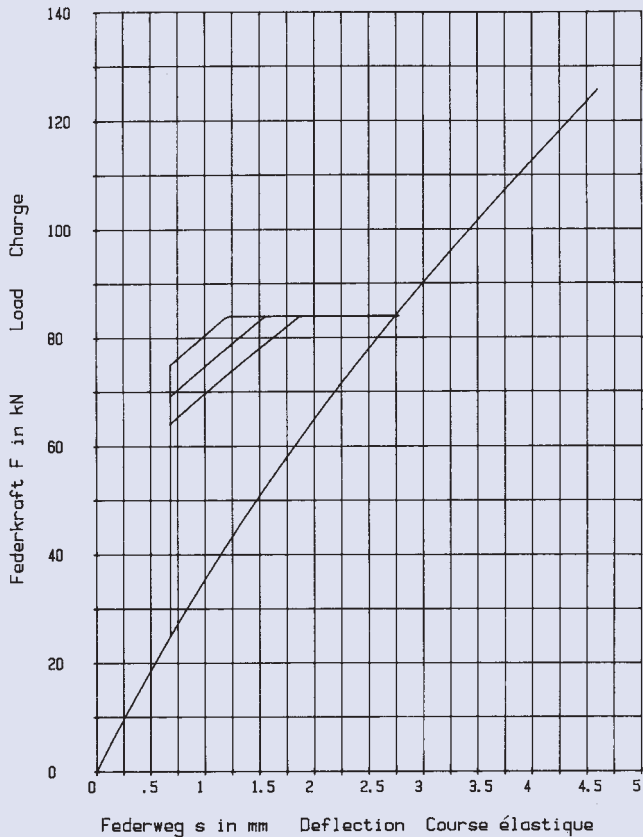
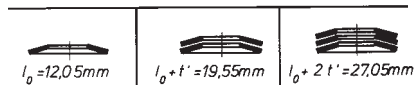

150 x 81 x 8,0

GR 3

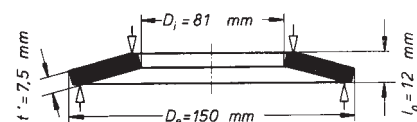
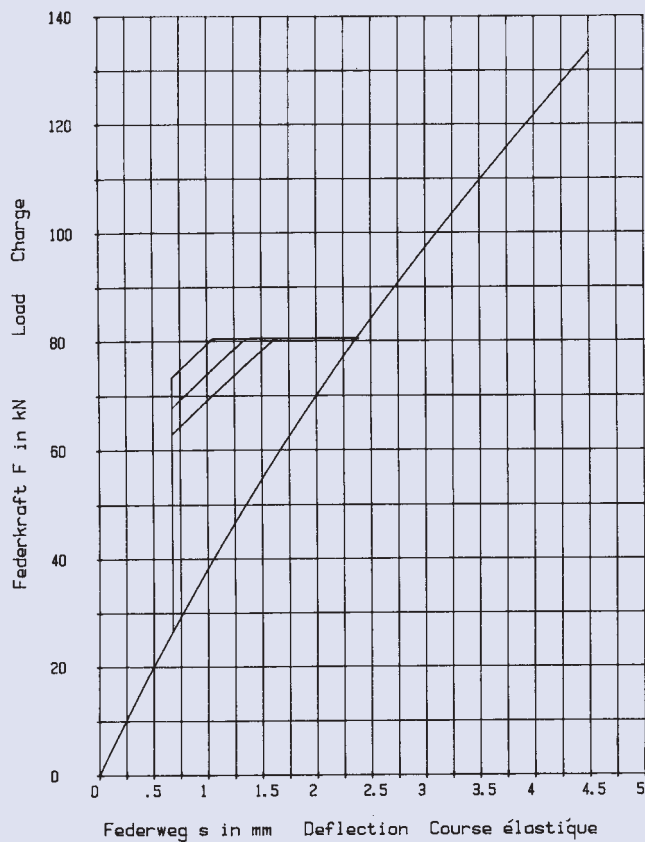

$h_0 = 4,0 \text{ mm}$      $D_e / D_i = 1,851$      $h'_0 = 4,5 \text{ mm}$   
 $t = 8,0 \text{ mm}$      $D_e / t = 18,75$      $t' / t = 0,937$   
 $h_0 / t = 0,5$      $m = 737 \text{ g}$      $h'_0 / t' = 0,6$

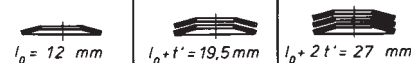

150 x 81 x 10

GR 3

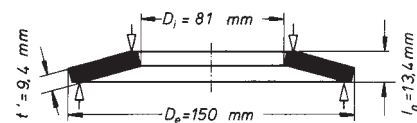
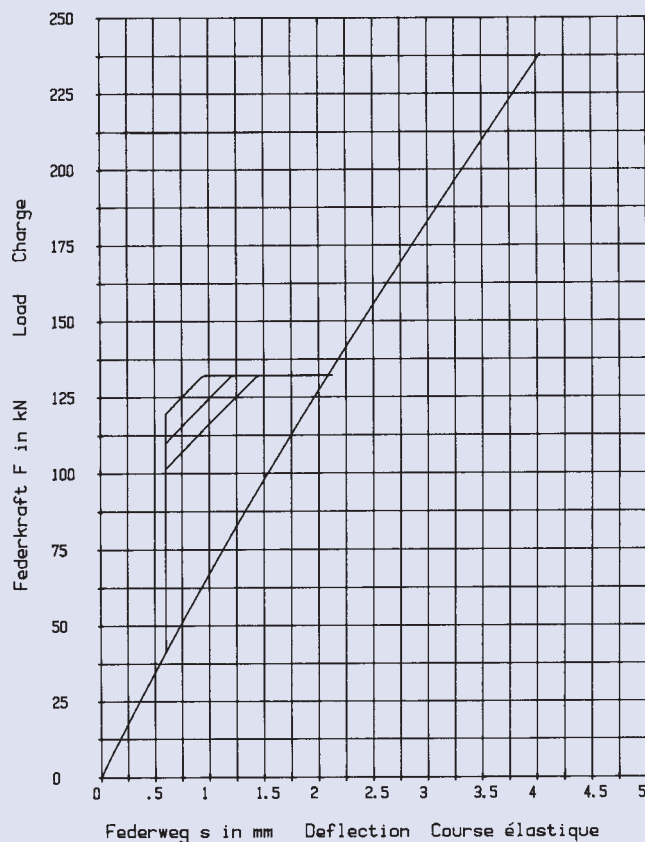

$h_0 = 3,4 \text{ mm}$      $D_e / D_i = 1,851$      $h'_0 = 4,0 \text{ mm}$   
 $t = 10 \text{ mm}$      $D_e / t = 15$      $t' / t = 0,94$   
 $h_0 / t = 0,34$      $m = 923,71 \text{ g}$      $h'_0 / t' = 0,426$

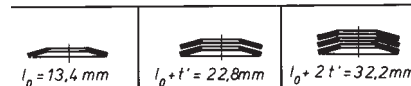

160 x 82 x 4,3

GR 2, DIN 2093 – C 160

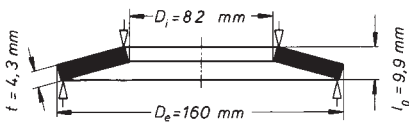

$h_0 = 5,6 \text{ mm}$        $D_e / D_i = 1,951$   
 $t = 4,3 \text{ mm}$        $D_e / t = 37,209$   
 $h_0 / t = 1,302$        $m = 500,409 \text{ g}$

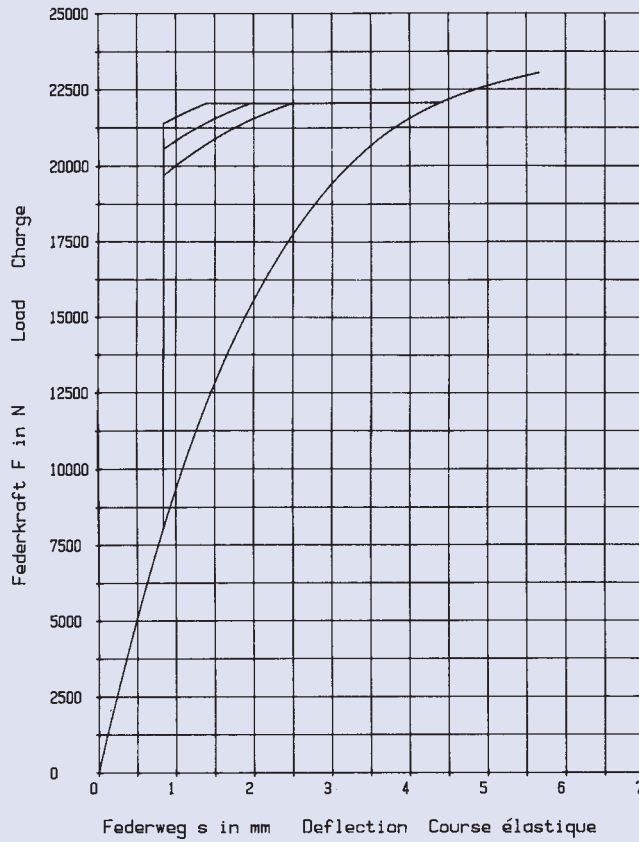
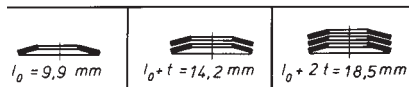

160 x 82 x 6,0

GR 2, DIN 2093 – B 160

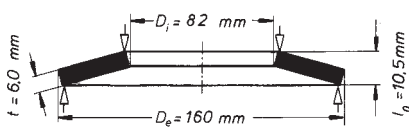

$h_0 = 4,5 \text{ mm}$        $D_e / D_i = 1,951$   
 $t = 6,0 \text{ mm}$        $D_e / t = 26,666$   
 $h_0 / t = 0,75$        $m = 698,246 \text{ g}$

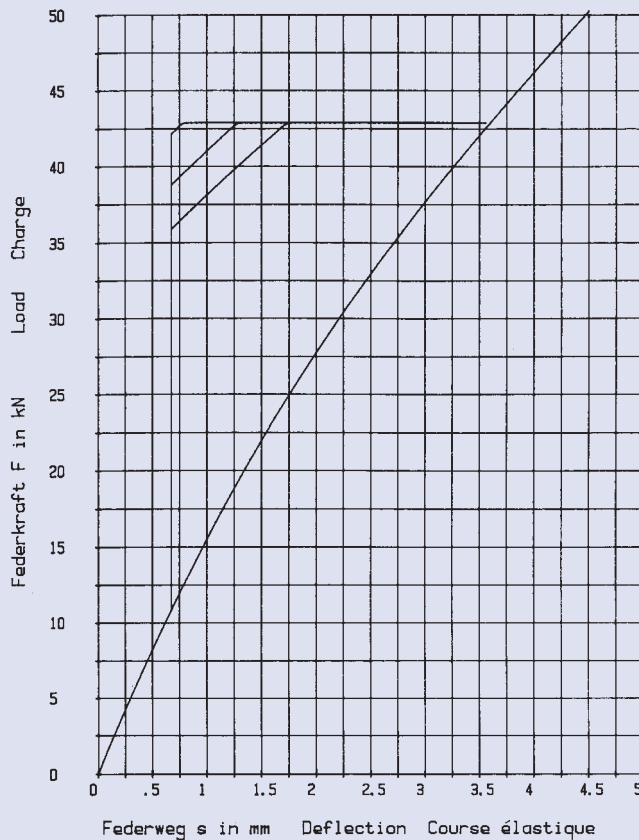
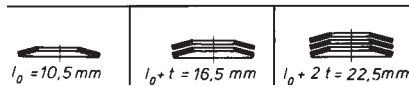

160 x 82 x 10

GR 3, DIN 2093 – A 160

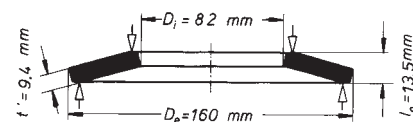
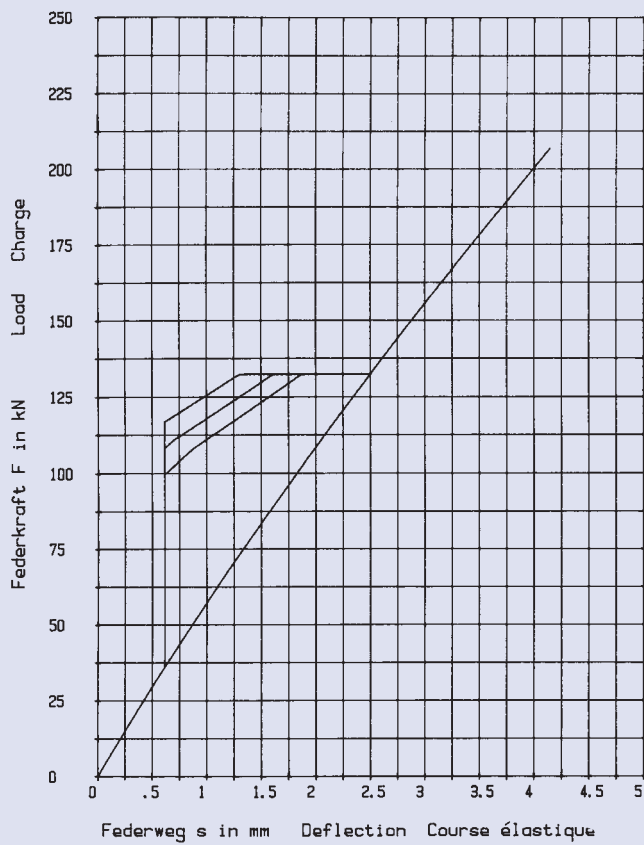

$h_0 = 3,5 \text{ mm}$      $D_e / D_i = 1,951$      $h'_0 = 4,1 \text{ mm}$   
 $t = 10 \text{ mm}$      $D_e / t = 16$      $t' / t = 0,94$   
 $h_0 / t = 0,35$      $m = 1,094 \text{ kg}$      $h'_0 / t' = 0,436$

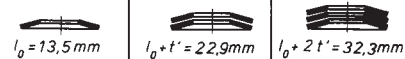

160 x 82 x 11

GR 3

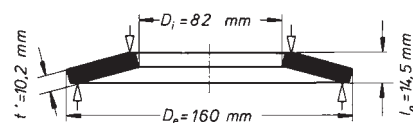
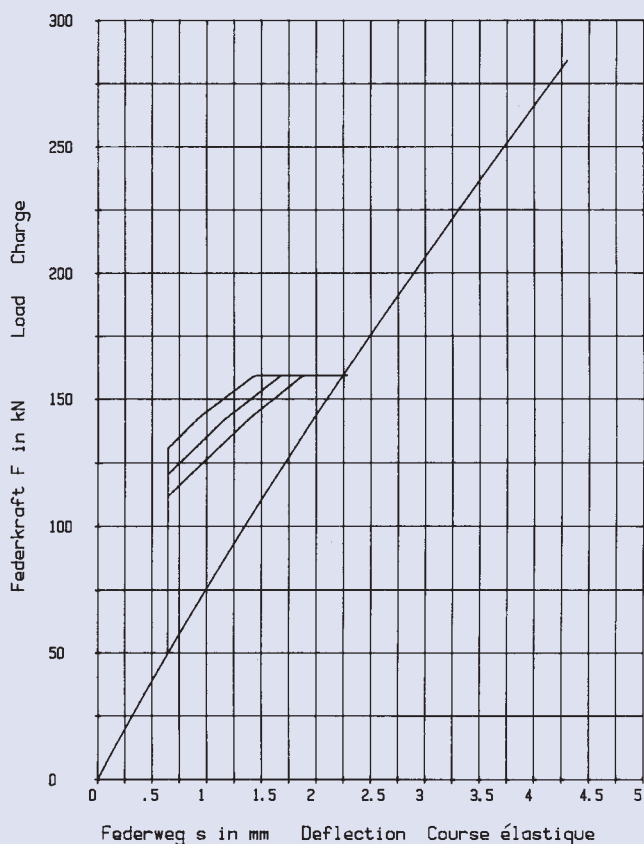

$h_0 = 3,5 \text{ mm}$      $D_e / D_i = 1,951$      $h'_0 = 4,3 \text{ mm}$   
 $t = 11 \text{ mm}$      $D_e / t = 14,545$      $t' / t = 0,927$   
 $h_0 / t = 0,318$      $m = 1,187 \text{ kg}$      $h'_0 / t' = 0,422$



180 x 92 x 4,8

GR 2, DIN 2093 – C 180

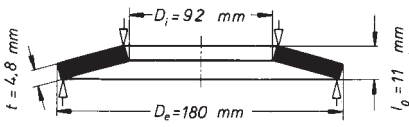

$h_0 = 6,2 \text{ mm}$        $D_e/D_i = 1,956$   
 $t = 4,8 \text{ mm}$        $D_e/t = 37,5$   
 $h_0/t = 1,291$        $m = 708,337 \text{ g}$

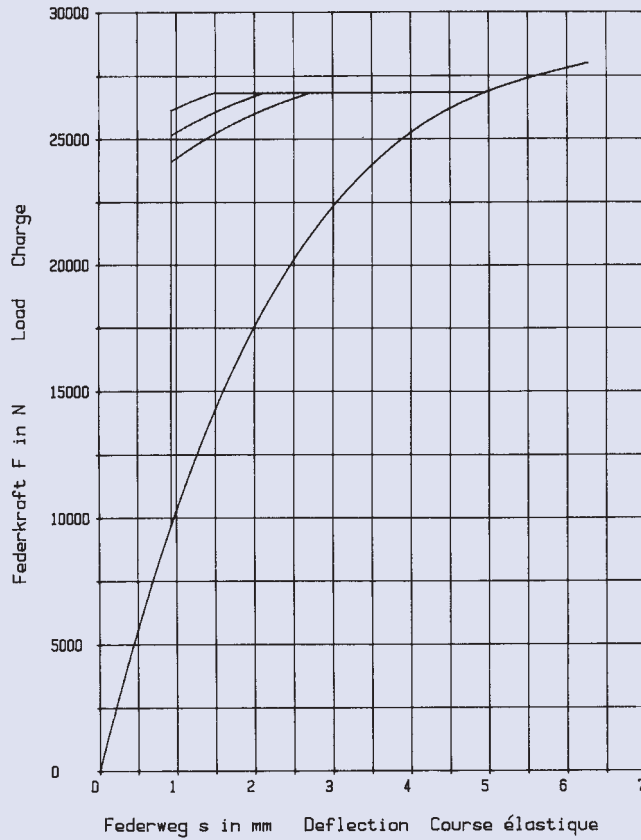
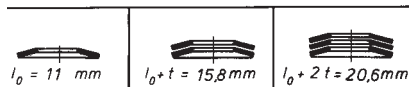

180 x 92 x 6,0

GR 2, DIN 2093 – B 180

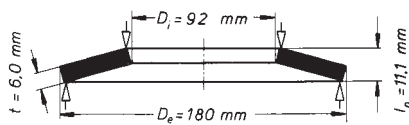

$h_0 = 5,1 \text{ mm}$        $D_e/D_i = 1,956$   
 $t = 6,0 \text{ mm}$        $D_e/t = 30$   
 $h_0/t = 0,85$        $m = 885,421 \text{ g}$

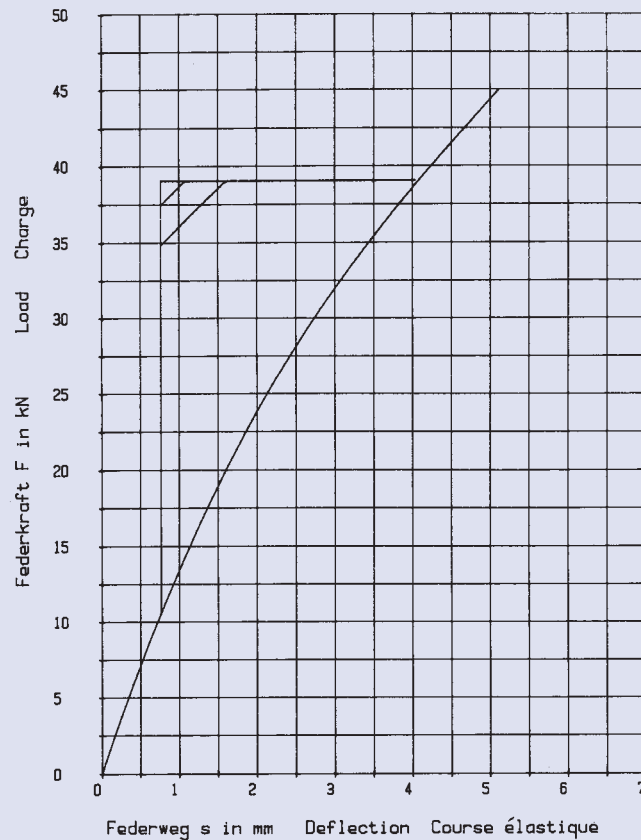
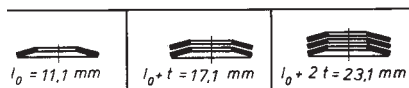



180 x 92 x 10

GR 3, DIN 2093 – A 180

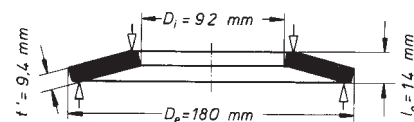
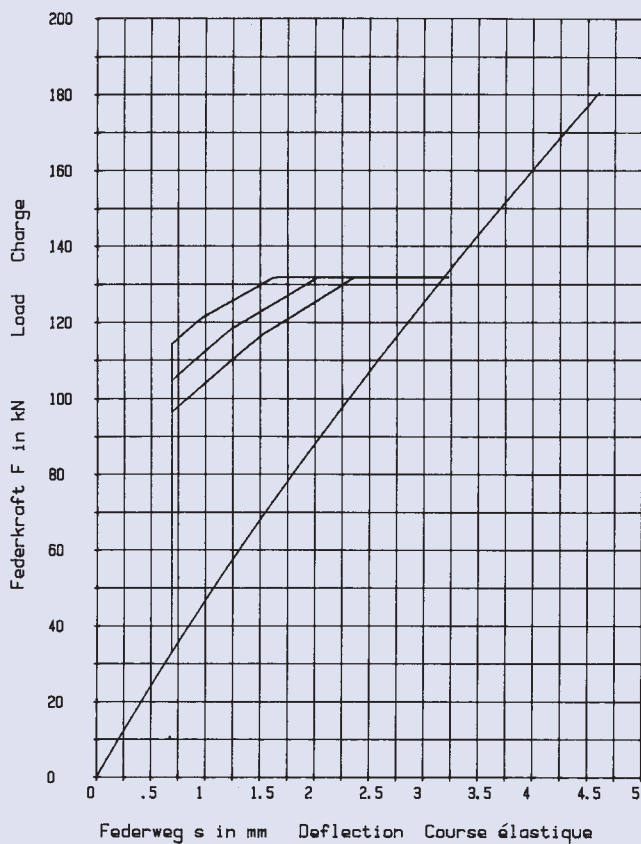

$h_0 = 4,0 \text{ mm}$      $D_e / D_i = 1,956$      $h'_0 = 4,6 \text{ mm}$   
 $t = 10 \text{ mm}$      $D_e / t = 18$      $t' / t = 0,94$   
 $h_0 / t = 0,4$      $m = 1,387 \text{ kg}$      $h'_0 / t' = 0,489$

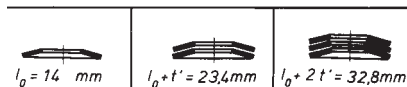

180 x 92 x 13

GR 3

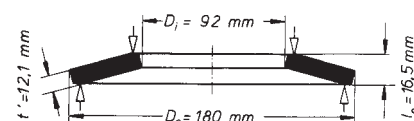
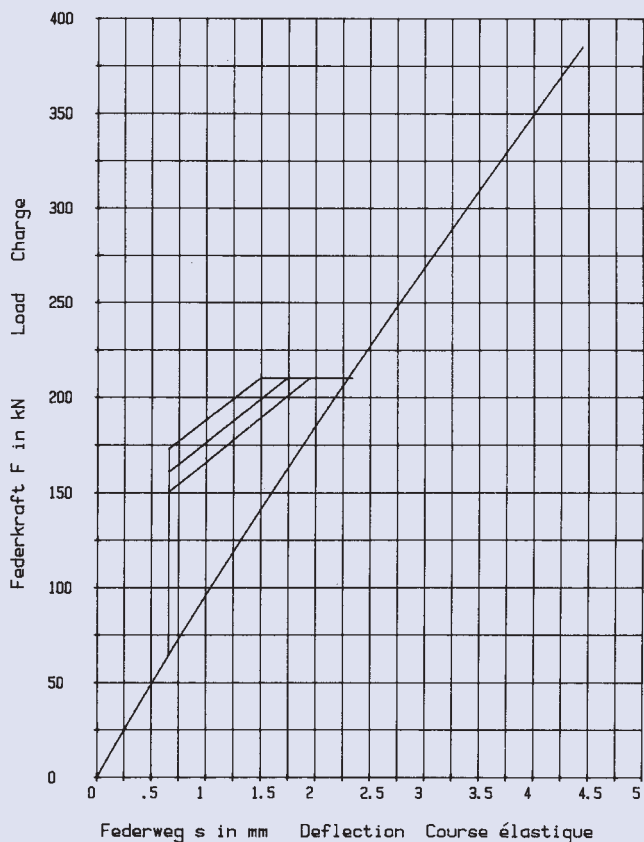

$h_0 = 3,5 \text{ mm}$      $D_e / D_i = 1,956$      $h'_0 = 4,4 \text{ mm}$   
 $t = 13 \text{ mm}$      $D_e / t = 13,846$      $t' / t = 0,93$   
 $h_0 / t = 0,269$      $m = 1,786 \text{ kg}$      $h'_0 / t' = 0,364$

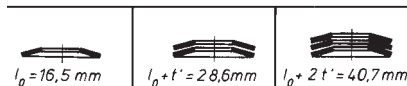

200 x 82 x 8,0

GR 3

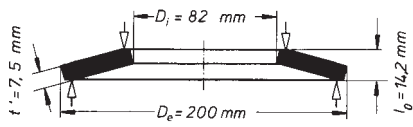

$h_0 = 6,2 \text{ mm}$      $D_e / D_i = 2,439$      $h_0' = 6,7 \text{ mm}$   
 $t = 8,0 \text{ mm}$      $D_e / t = 25$      $t' / t = 0,937$   
 $h_0 / t = 0,775$      $m = 1,539 \text{ kg}$      $h_0' / t' = 0,893$

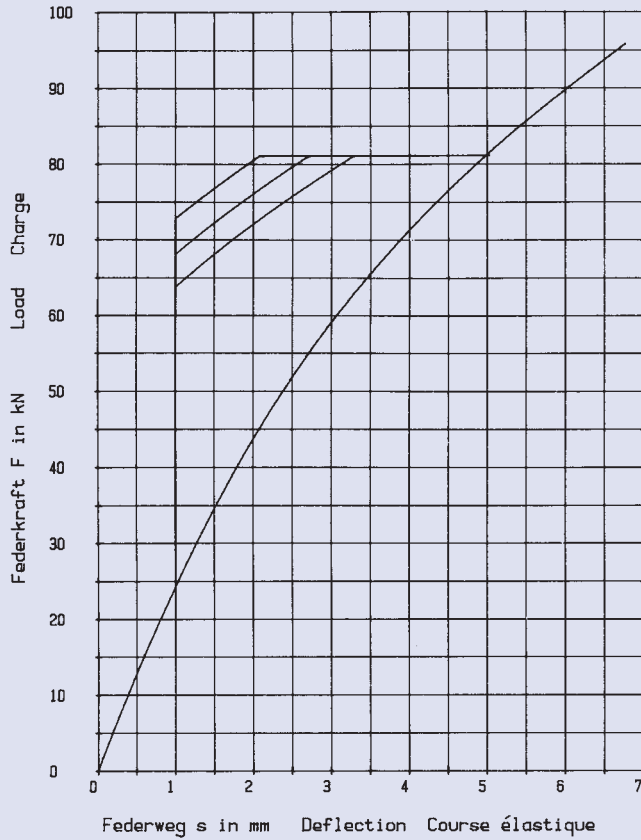
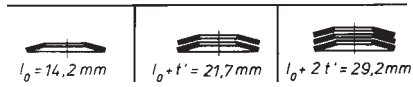

200 x 82 x 10

GR 3

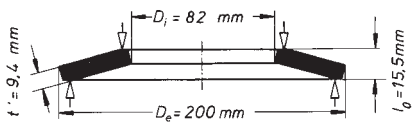

$h_0 = 5,5 \text{ mm}$      $D_e / D_i = 2,439$      $h_0' = 6,1 \text{ mm}$   
 $t = 10 \text{ mm}$      $D_e / t = 20$      $t' / t = 0,94$   
 $h_0 / t = 0,55$      $m = 1,928 \text{ kg}$      $h_0' / t' = 0,649$

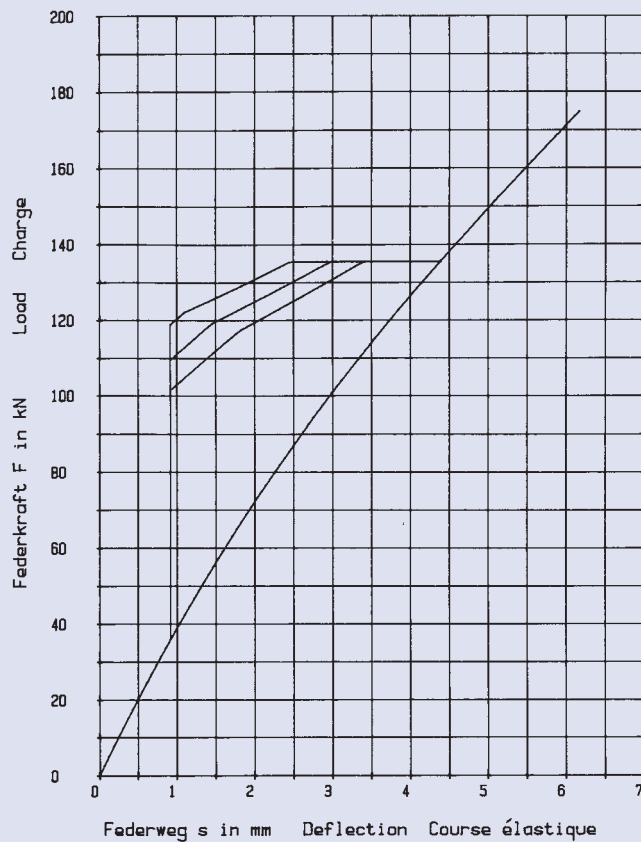
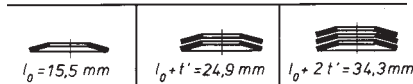

200 x 82 x 12

GR 3

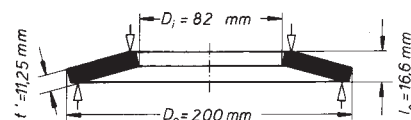
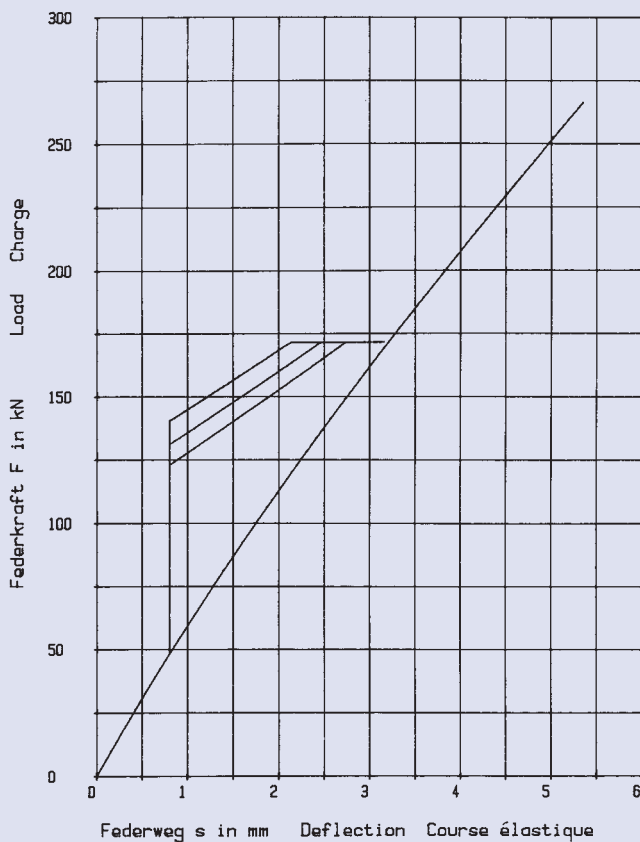

$h_0 = 4,6 \text{ mm}$	$D_e / D_1 = 2,439$	$h'_0 = 5,35 \text{ mm}$
$t = 12 \text{ mm}$	$D_e / t = 16,667$	$t' / t = 0,937$
$h_0 / t = 0,383$	$m = 2,308 \text{ kg}$	$h'_0 / t' = 0,476$

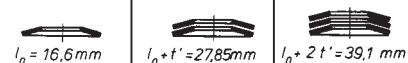

200 x 92 x 10

GR 3

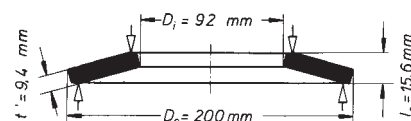
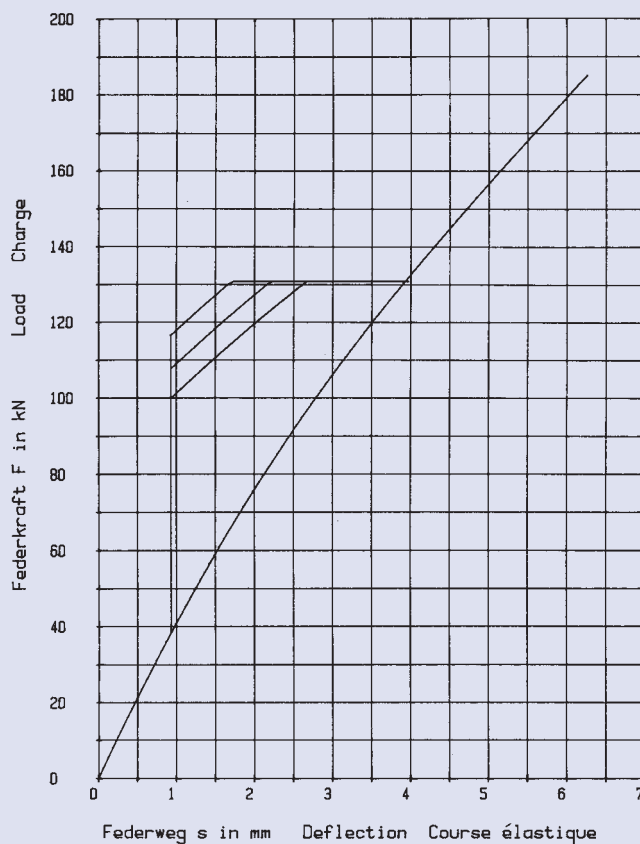

$h_0 = 5,6 \text{ mm}$	$D_e / D_1 = 2,173$	$h'_0 = 6,2 \text{ mm}$
$t = 10 \text{ mm}$	$D_e / t = 20$	$t' / t = 0,94$
$h_0 / t = 0,56$	$m = 1,828 \text{ kg}$	$h'_0 / t' = 0,66$

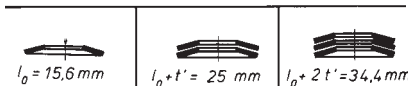

200 x 92 x 12

GR 3

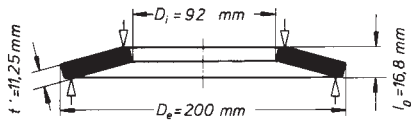

$h_0 = 4,8 \text{ mm}$      $D_e / D_i = 2,173$      $h_0' = 5,55 \text{ mm}$   
 $t = 12 \text{ mm}$      $D_e / t = 16,667$      $t' / t = 0,937$   
 $h_0 / t = 0,4$      $m = 2,187$      $h_0' / t' = 0,493$

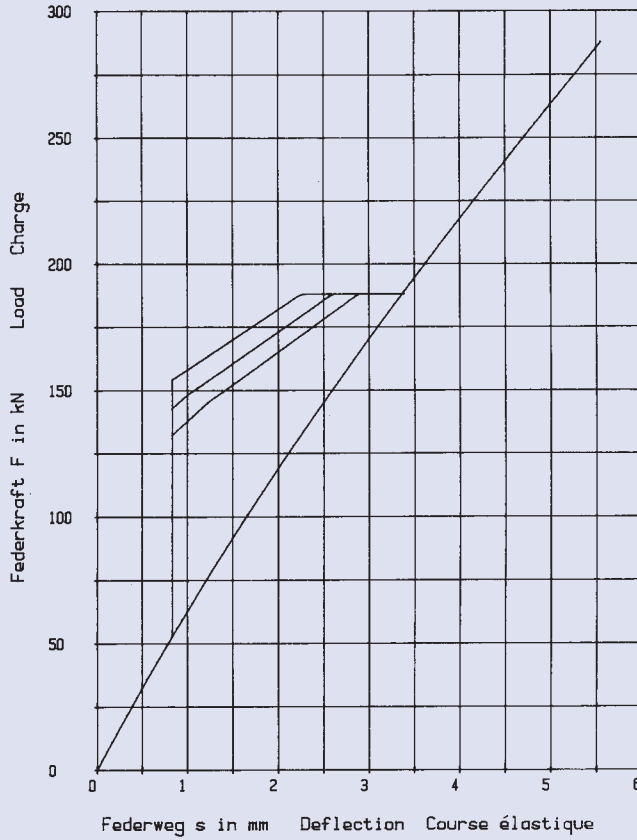
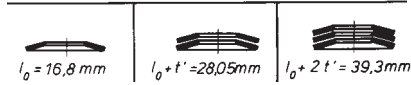

200 x 92 x 14

GR 3

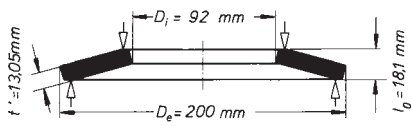

$h_0 = 4,1 \text{ mm}$      $D_e / D_i = 2,173$      $h_0' = 5,05 \text{ mm}$   
 $t = 14 \text{ mm}$      $D_e / t = 14,285$      $t' / t = 0,932$   
 $h_0 / t = 0,292$      $m = 2,537 \text{ kg}$      $h_0' / t' = 0,387$

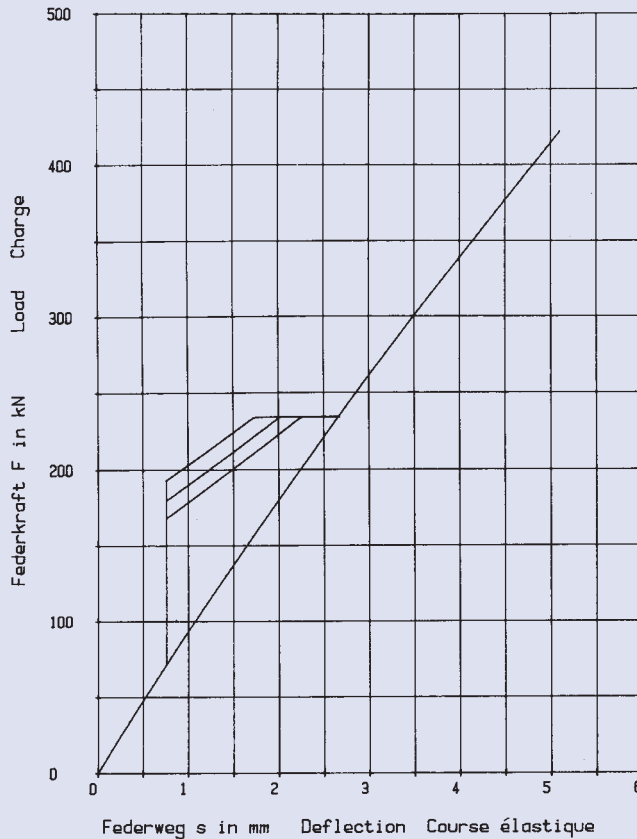
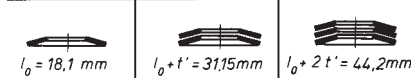

200 x 102 x 5,5

GR 2, DIN 2093 – C 200

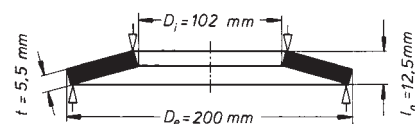

$h_0 = 7,0 \text{ mm}$        $D_e / D_1 = 1,96$   
 $t = 5,5 \text{ mm}$        $D_e / t = 36,363$   
 $h_0 / t = 1,272$        $m = 1,004 \text{ kg}$

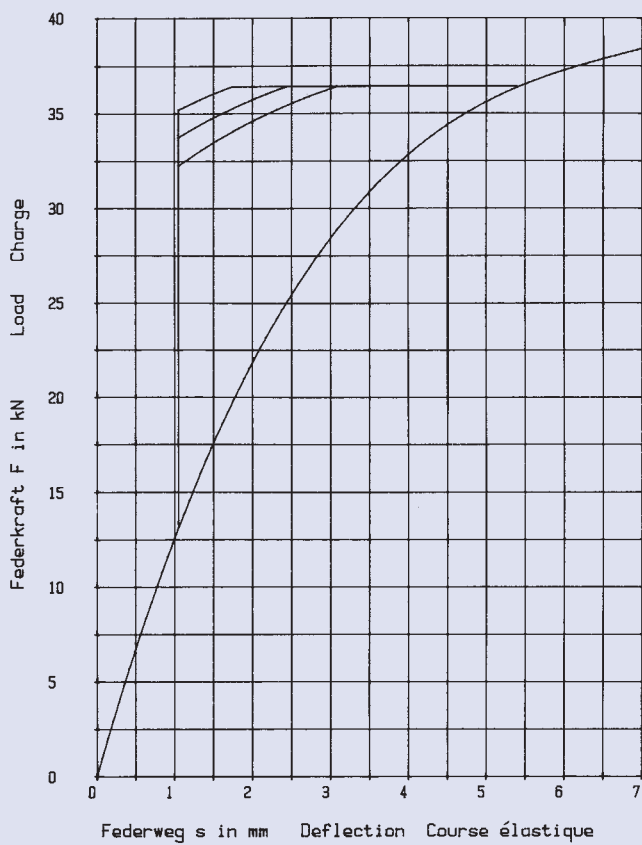
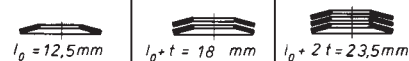

200 x 102 x 8,0

GR 3, DIN 2093 – B 200

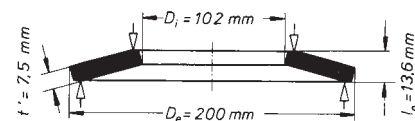

$h_0 = 5,6 \text{ mm}$        $D_e / D_1 = 1,96$        $h'_0 = 6,1 \text{ mm}$   
 $t = 8,0 \text{ mm}$        $D_e / t = 25$        $t' / t = 0,937$   
 $h_0 / t = 0,7$        $m = 1,368 \text{ kg}$        $h'_0 / t' = 0,813$

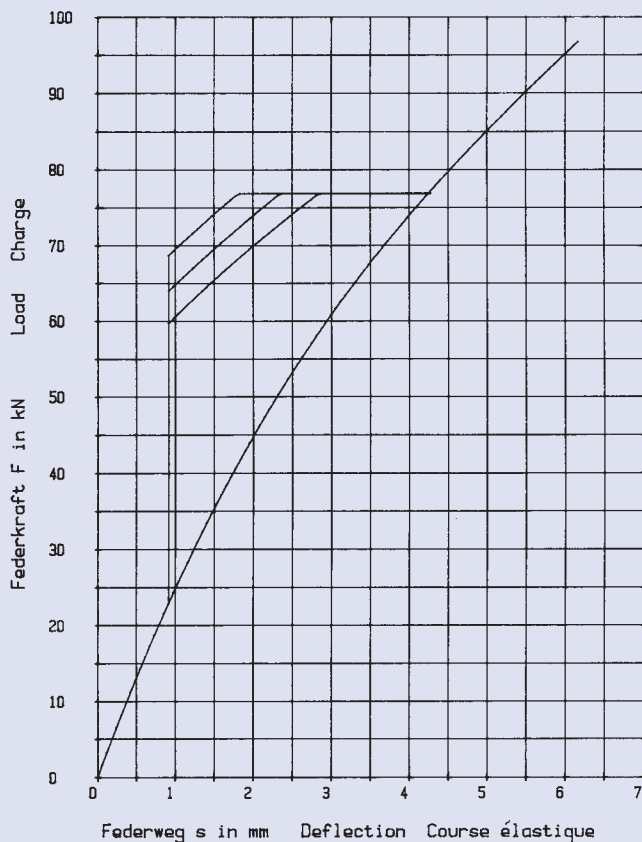
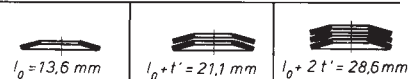

200 x 102 x 10

GR 3

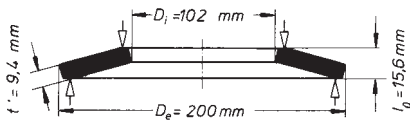

$h_0 = 5,6 \text{ mm}$      $D_e / D_i = 1,96$      $h'_0 = 6,2 \text{ mm}$   
 $t = 10 \text{ mm}$      $D_e / t = 20$      $t' / t = 0,94$   
 $h_0 / t = 0,56$      $m = 1,716 \text{ kg}$      $h'_0 / t' = 0,66$

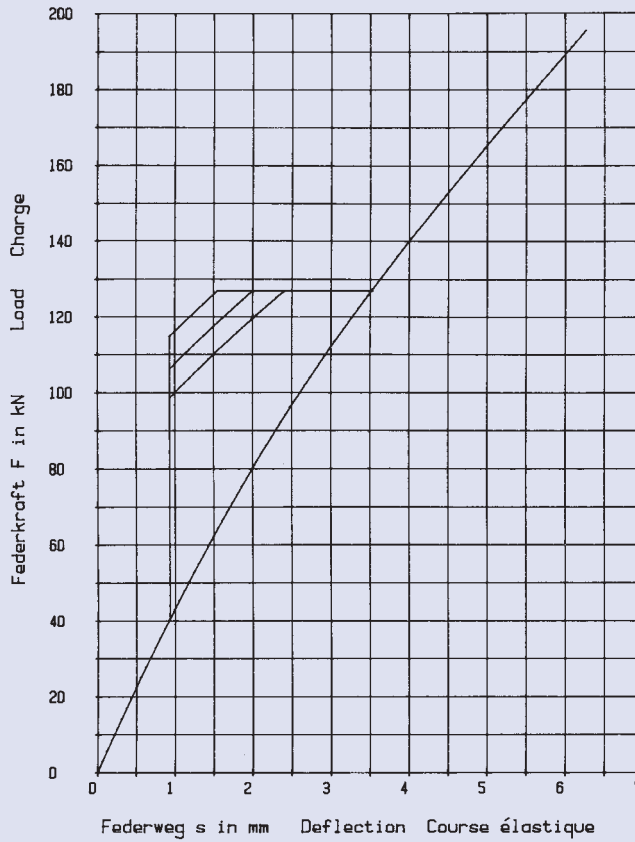
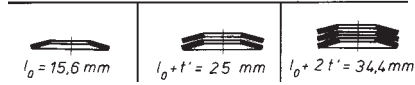

200 x 102 x 12

GR 3, DIN 2093 – A 200

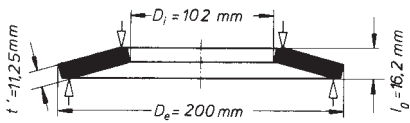

$h_0 = 4,2 \text{ mm}$      $D_e / D_i = 1,96$      $h'_0 = 4,95 \text{ mm}$   
 $t = 12 \text{ mm}$      $D_e / t = 16,666$      $t' / t = 0,937$   
 $h_0 / t = 0,35$      $m = 2,053 \text{ kg}$      $h'_0 / t' = 0,44$

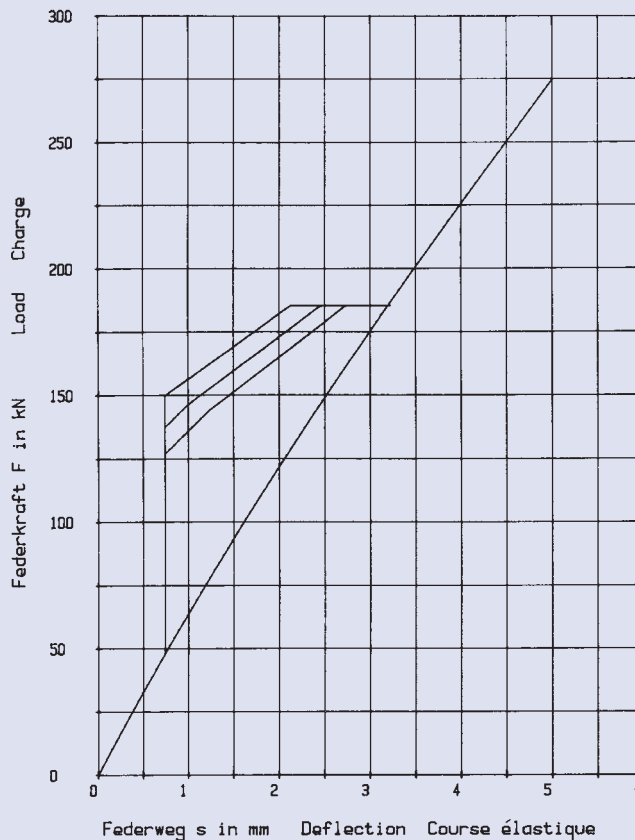
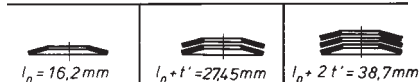

200 x 102 x 14

GR 3

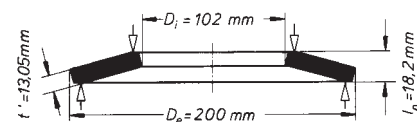
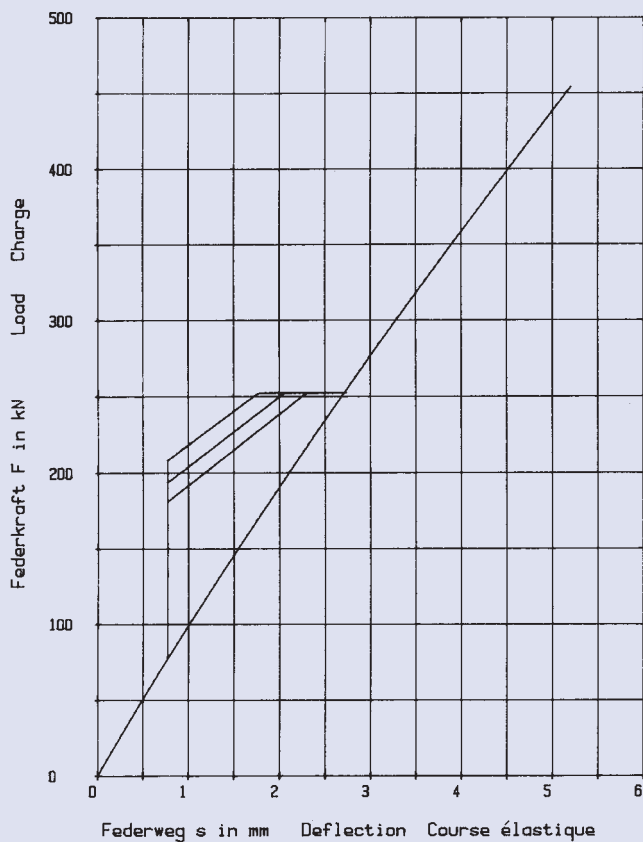

$h_0 = 4,2 \text{ mm}$      $D_e / D_i = 1,96$      $h'_0 = 5,15 \text{ mm}$   
 $t = 14 \text{ mm}$      $D_e / t = 14,285$      $t' / t = 0,932$   
 $h_0 / t = 0,3$      $m = 2,381 \text{ kg}$      $h'_0 / t' = 0,395$



200 x 112 x 12

GR 3

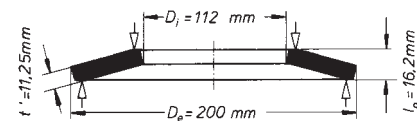
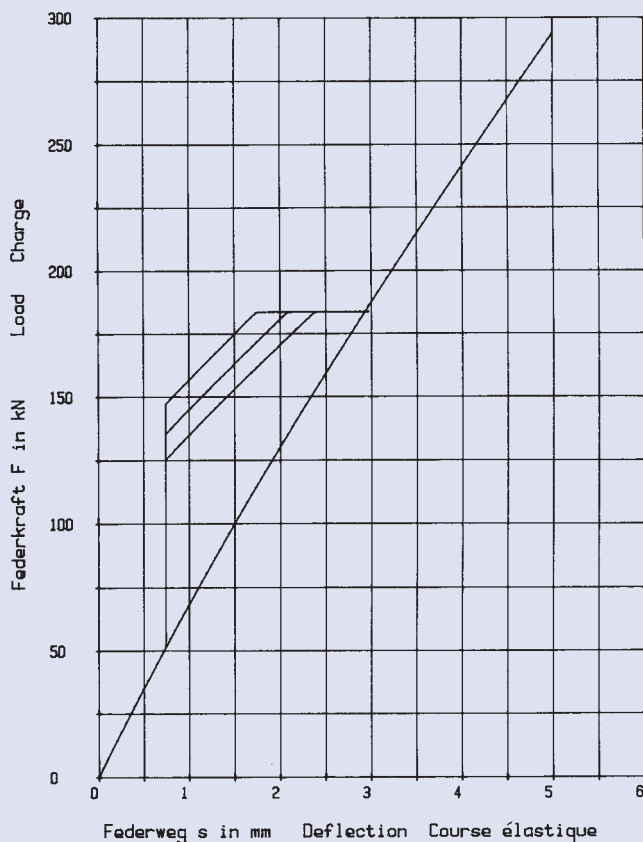

$h_0 = 4,2 \text{ mm}$      $D_e / D_i = 1,785$      $h'_0 = 4,95 \text{ mm}$   
 $t = 12 \text{ mm}$      $D_e / t = 16,667$      $t' / t = 0,937$   
 $h_0 / t = 0,35$      $m = 1,904 \text{ kg}$      $h'_0 / t' = 0,44$

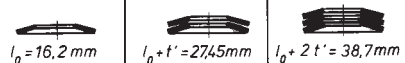

200 x 112 x 14

GR 3

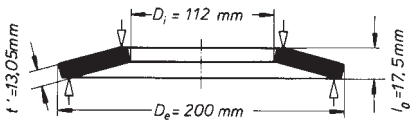

$h_0 = 3,5 \text{ mm}$	$D_e / D_i = 1,785$	$h_0' = 4,45 \text{ mm}$
$t = 14 \text{ mm}$	$D_e / t = 14,285$	$t' / t = 0,932$
$h_0 / t = 0,25$	$m = 2,209 \text{ kg}$	$h_0' / t' = 0,341$

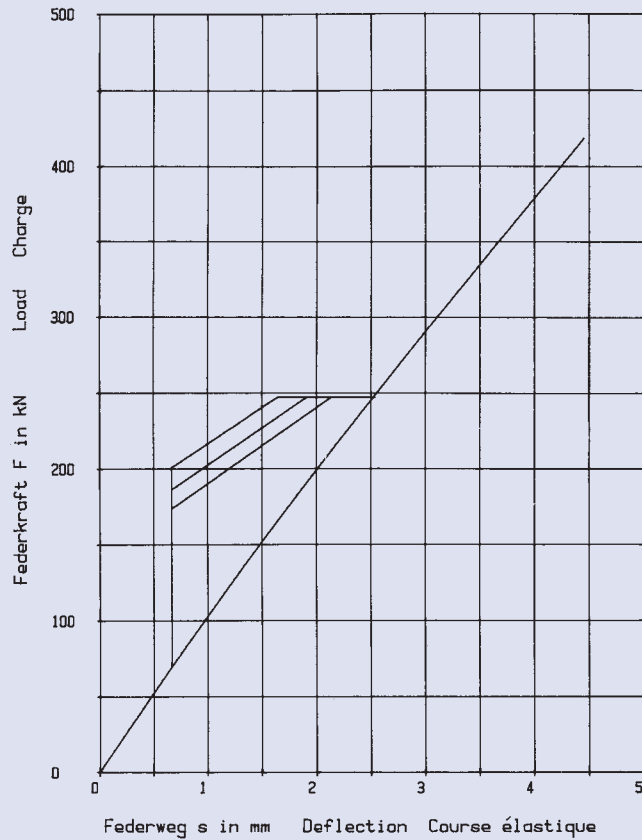
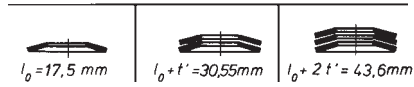

200 x 112 x 16

GR 3

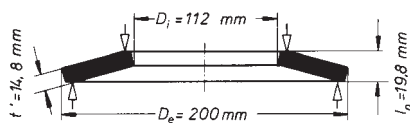

$h_0 = 3,8 \text{ mm}$	$D_e / D_i = 1,785$	$h_0' = 5,0 \text{ mm}$
$t = 16 \text{ mm}$	$D_e / t = 12,5$	$t' / t = 0,925$
$h_0 / t = 0,237$	$m = 2,505 \text{ kg}$	$h_0' / t' = 0,338$

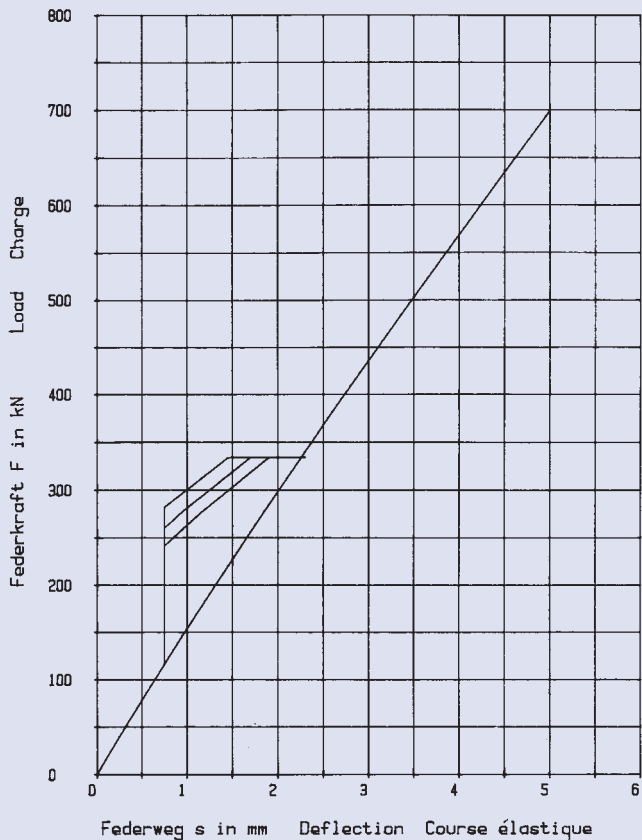
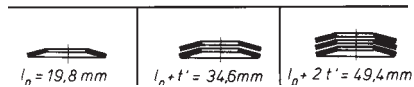



225 x 112 x 6,5

GR 3, DIN 2093 – C 225

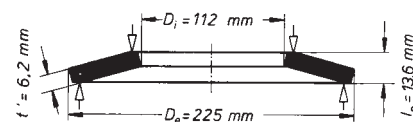

$h_0 = 7,1 \text{ mm}$      $D_e / D_i = 2,008$      $h'_0 = 7,4 \text{ mm}$   
 $t = 6,5 \text{ mm}$      $D_e / t = 34,615$      $t' / t = 0,953$   
 $h_0 / t = 1,092$      $m = 1,455 \text{ kg}$      $h'_0 / t' = 1,194$

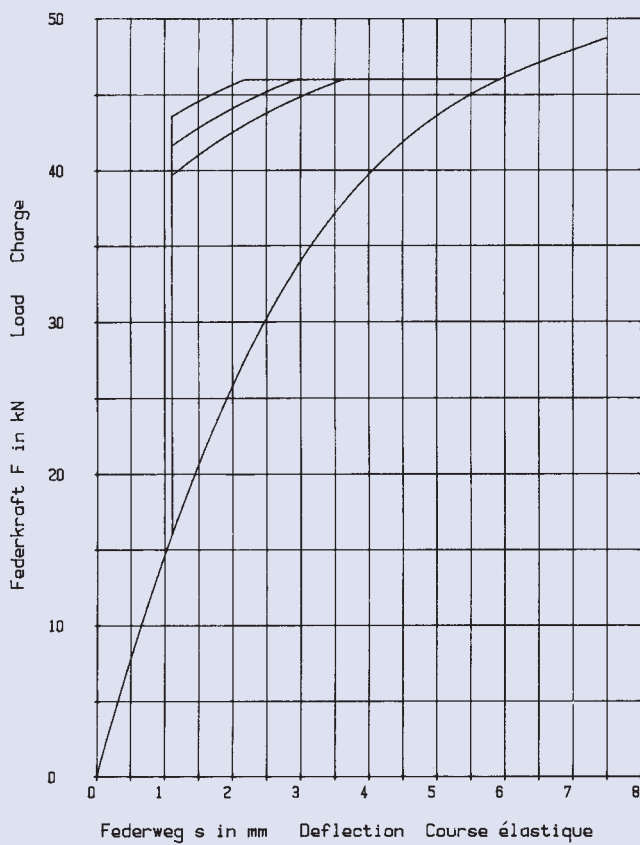
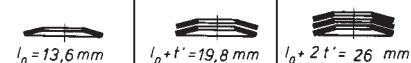

225 x 112 x 8,0

GR 3, DIN 2093 – B 225

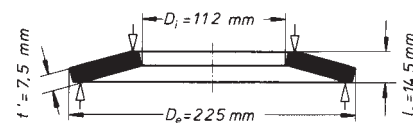

$h_0 = 6,5 \text{ mm}$      $D_e / D_i = 2,008$      $h'_0 = 7,0 \text{ mm}$   
 $t = 8,0 \text{ mm}$      $D_e / t = 28,125$      $t' / t = 0,937$   
 $h_0 / t = 0,812$      $m = 1,761 \text{ kg}$      $h'_0 / t' = 0,933$

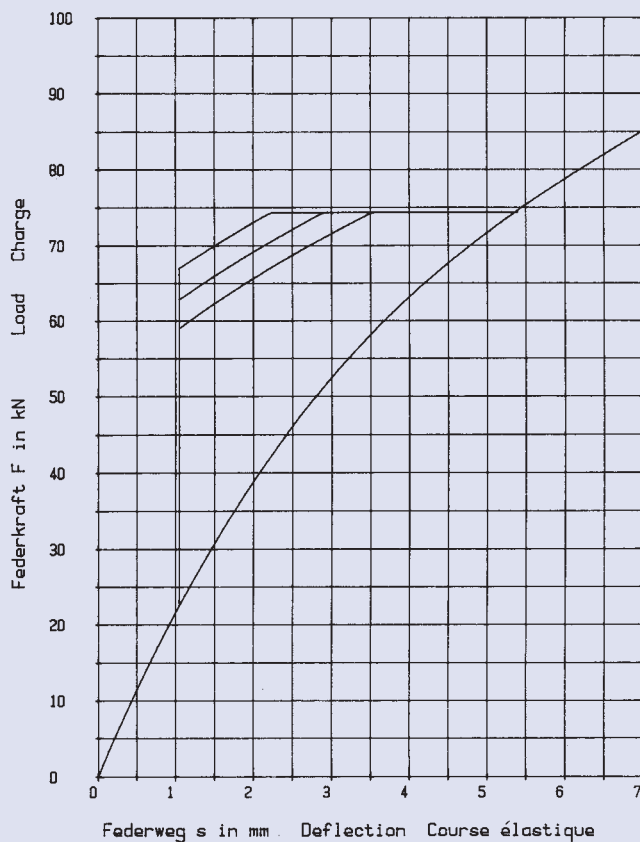
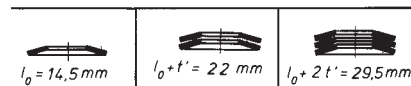

225 x 112 x 12

GR 3, DIN 2093 – A 225

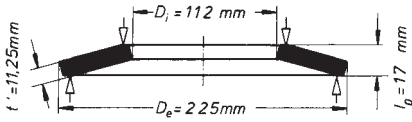

$h_0 = 5,0 \text{ mm}$      $D_e / D_i = 2,008$      $h_0' = 5,75 \text{ mm}$   
 $t = 12 \text{ mm}$      $D_e / t = 18,75$      $t' / t = 0,937$   
 $h_0 / t = 0,416$      $m = 2,641 \text{ kg}$      $h_0' / t' = 0,511$

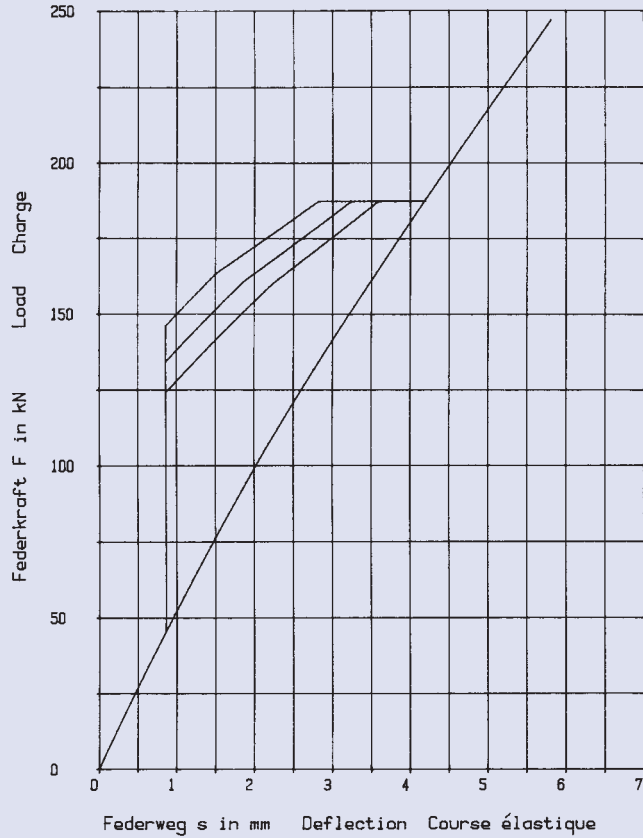
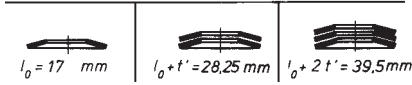

225 x 112 x 16

GR 3

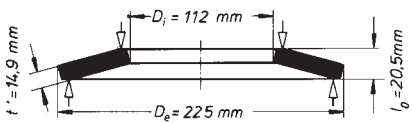

$h_0 = 4,5 \text{ mm}$      $D_e / D_i = 2,008$      $h_0' = 5,6 \text{ mm}$   
 $t = 16 \text{ mm}$      $D_e / t = 14,062$      $t' / t = 0,931$   
 $h_0 / t = 0,281$      $m = 3,498 \text{ kg}$      $h_0' / t' = 0,376$

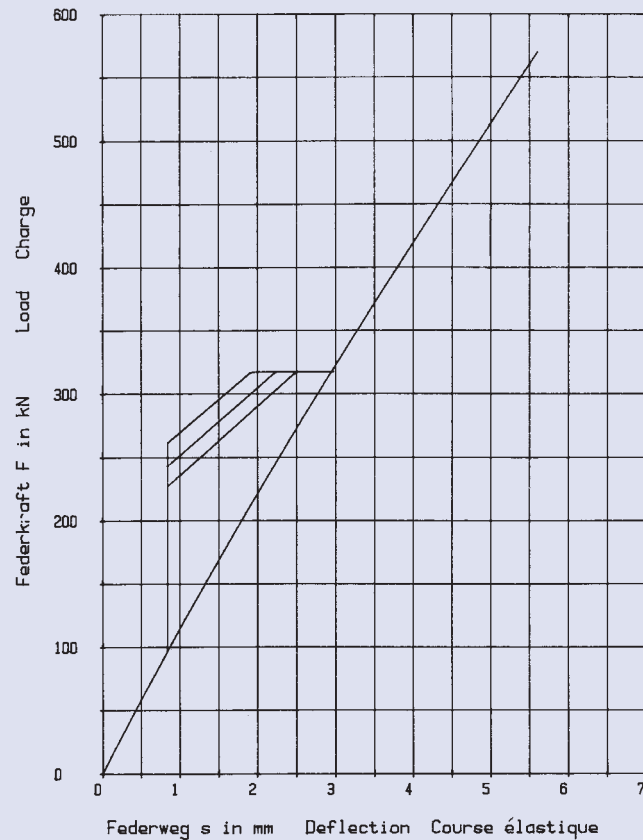
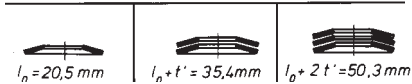

250 x 102 x 10

GR 3

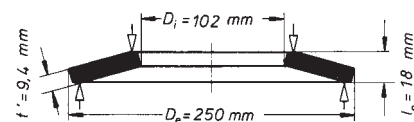
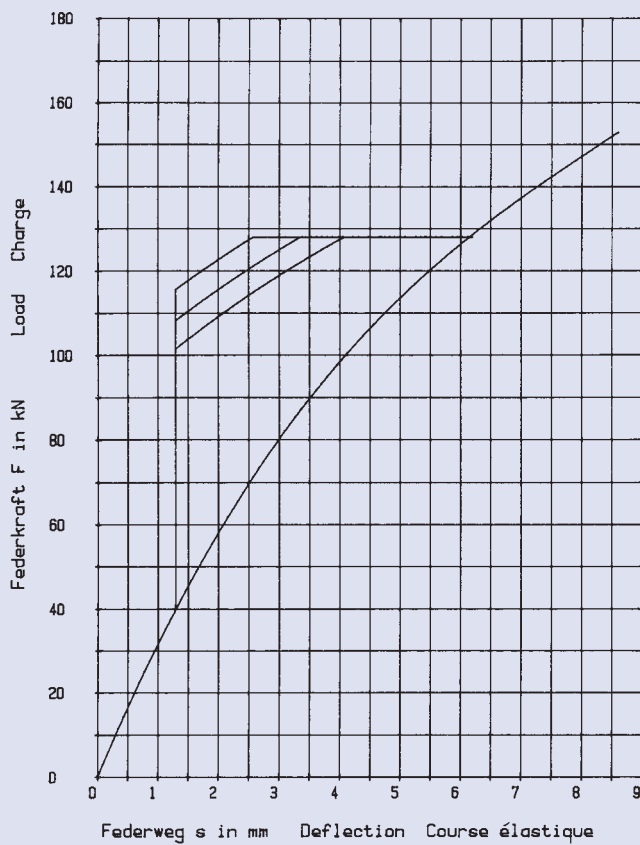

$h_0 = 8,0 \text{ mm}$      $D_e / D_i = 2,45$      $h'_0 = 8,6 \text{ mm}$   
 $t = 10 \text{ mm}$      $D_e / t = 25$      $t' / t = 0,94$   
 $h_0 / t = 0,8$      $m = 3,019 \text{ kg}$      $h'_0 / t' = 0,915$

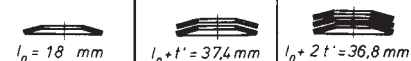

250 x 102 x 12

GR 3

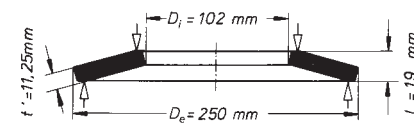
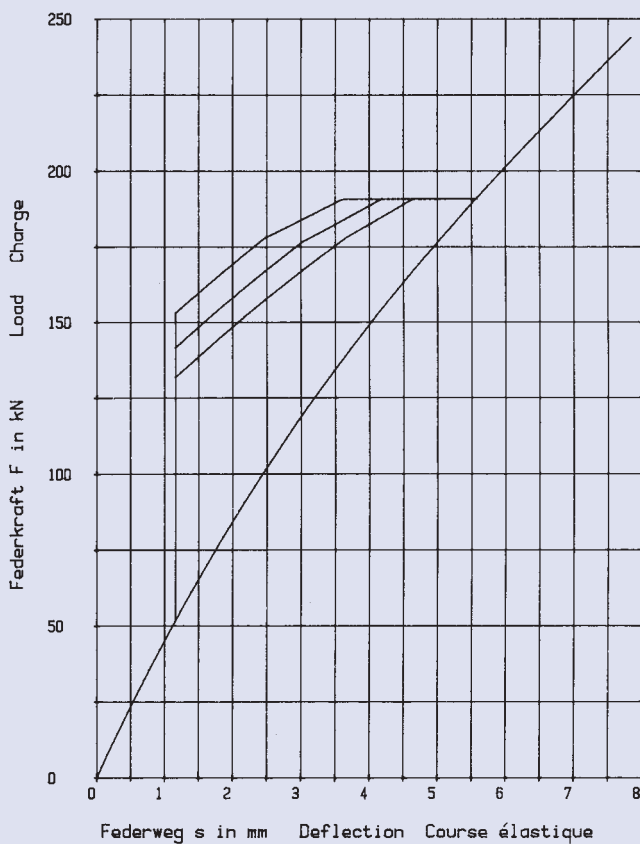

$h_0 = 7,0 \text{ mm}$      $D_e / D_i = 2,45$      $h'_0 = 7,75 \text{ mm}$   
 $t = 12 \text{ mm}$      $D_e / t = 20,833$      $t' / t = 0,937$   
 $h_0 / t = 0,583$      $m = 3,613 \text{ kg}$      $h'_0 / t' = 0,689$

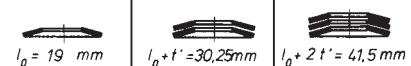

250 x 127 x 7,0

GR 3, DIN 2093 – C 250

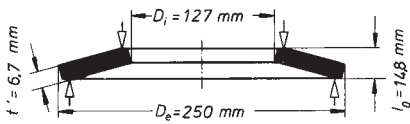

$h_0 = 7,8 \text{ mm}$	$D_e / D_i = 1,968$	$h'_0 = 8,1 \text{ mm}$
$t = 7,0 \text{ mm}$	$D_e / t = 35,714$	$t' / t = 0,957$
$h_0 / t = 1,114$	$m = 1,915 \text{ kg}$	$h''_0 / t = 1,209$

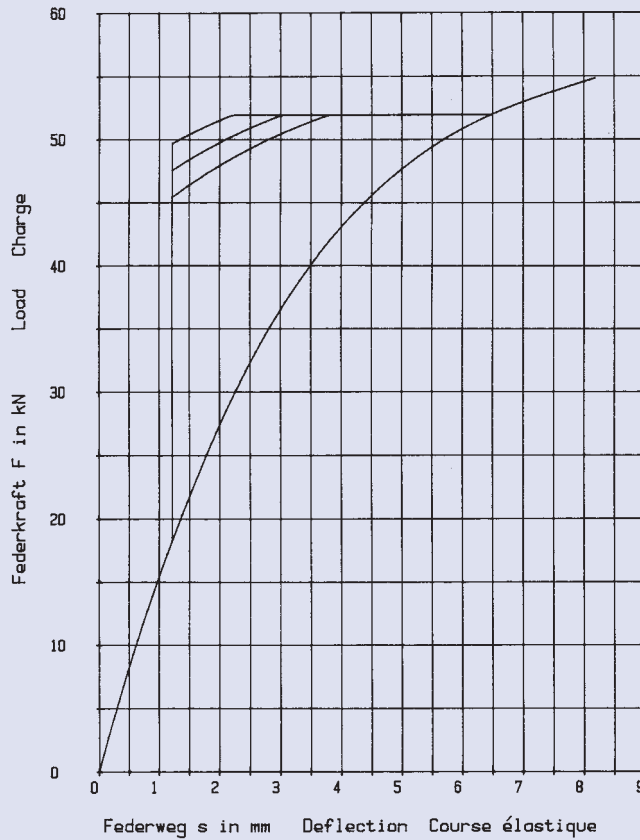
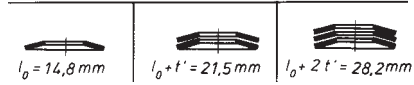

250 x 127 x 8,0

GR 3

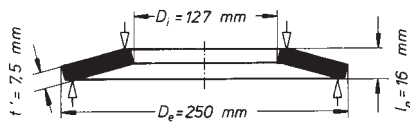

$h_0 = 8,0 \text{ mm}$	$D_e / D_i = 1,968$	$h'_0 = 8,5 \text{ mm}$
$t = 8,0 \text{ mm}$	$D_e / t = 31,25$	$t' / t = 0,937$
$h_0 / t = 1,0$	$m = 2,144 \text{ kg}$	$h''_0 / t = 1,133$

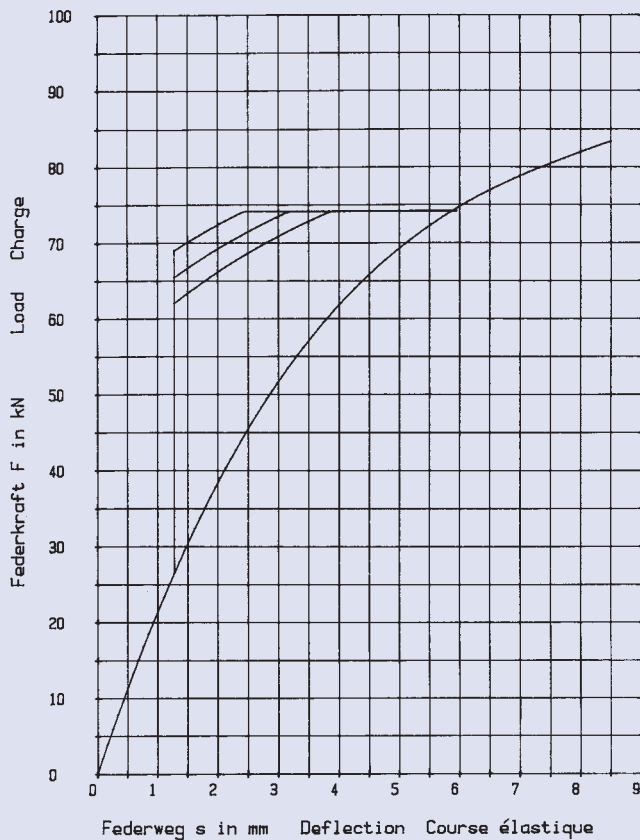
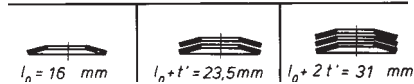

250 x 127 x 10

GR 3, DIN 2093 – B 250

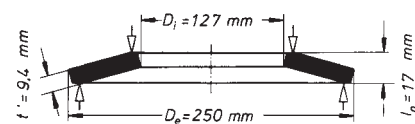

$h_0 = 7,0 \text{ mm}$	$D_e / D_i = 1,968$	$h'_0 = 7,6 \text{ mm}$
$t = 10 \text{ mm}$	$D_e / t = 25$	$t' / t = 0,94$
$h_0 / t = 0,7$	$m = 2,687 \text{ kg}$	$h'_0 / t' = 0,809$

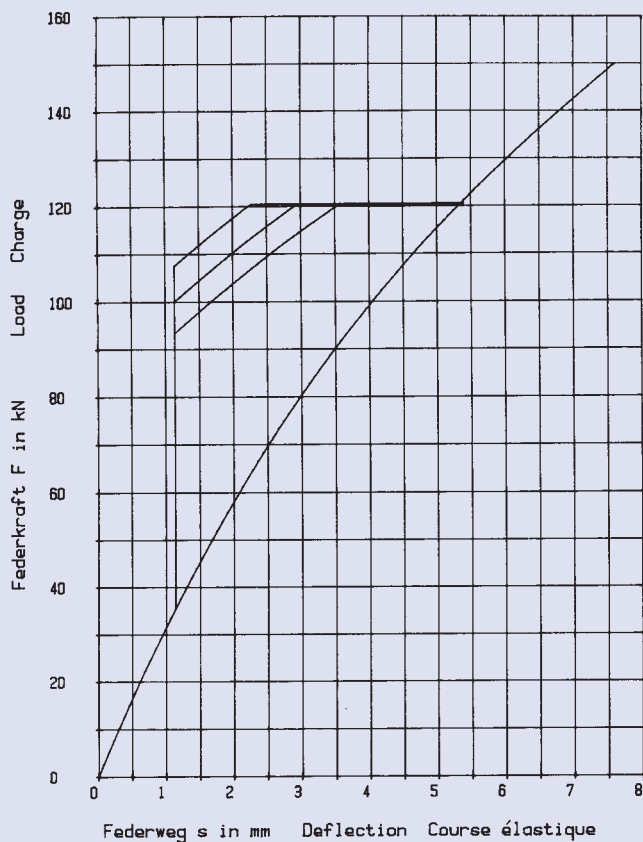
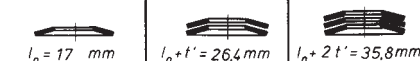

250 x 127 x 12

GR 3

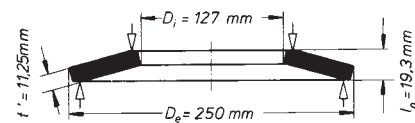

$h_0 = 7,3 \text{ mm}$	$D_e / D_i = 1,968$	$h'_0 = 8,05 \text{ mm}$
$t = 12 \text{ mm}$	$D_e / t = 20,833$	$t' / t = 0,937$
$h_0 / t = 0,608$	$m = 3,216 \text{ kg}$	$h'_0 / t' = 0,716$

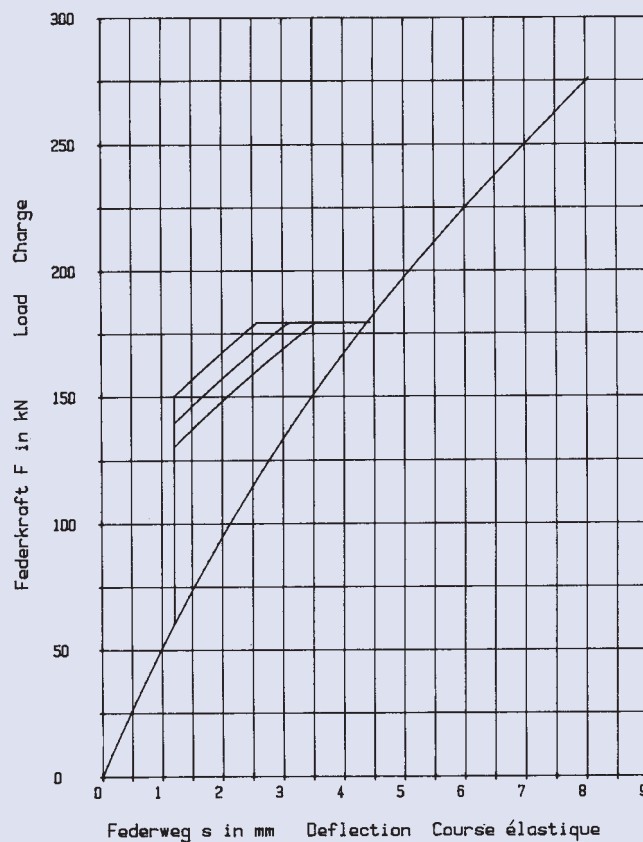
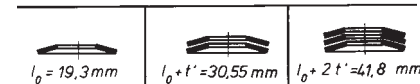

250 x 127 x 14

GR 3, DIN 2093 – A 250

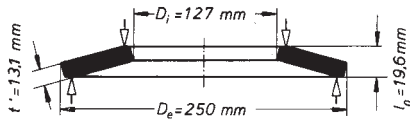

$h_0 = 5,6 \text{ mm}$      $D_e / D_i = 1,968$      $h_0' = 6,5 \text{ mm}$   
 $t = 14 \text{ mm}$      $D_e / t = 17,857$      $t' / t = 0,935$   
 $h_0' / t = 0,4$      $m = 3,745 \text{ kg}$      $h_0' / t' = 0,496$

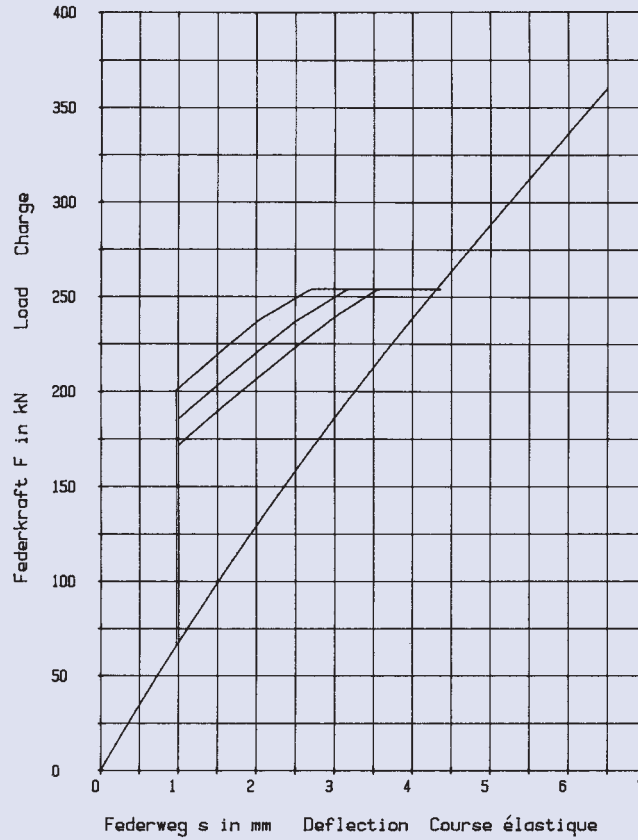
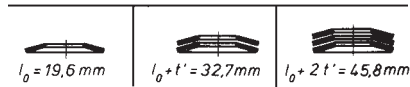

250 x 127 x 16

GR 3

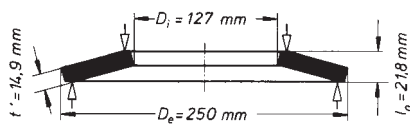

$h_0 = 5,8 \text{ mm}$      $D_e / D_i = 1,968$      $h_0' = 6,9 \text{ mm}$   
 $t = 16 \text{ mm}$      $D_e / t = 15,625$      $t' / t = 0,931$   
 $h_0' / t = 0,362$      $m = 4,260 \text{ kg}$      $h_0' / t' = 0,463$

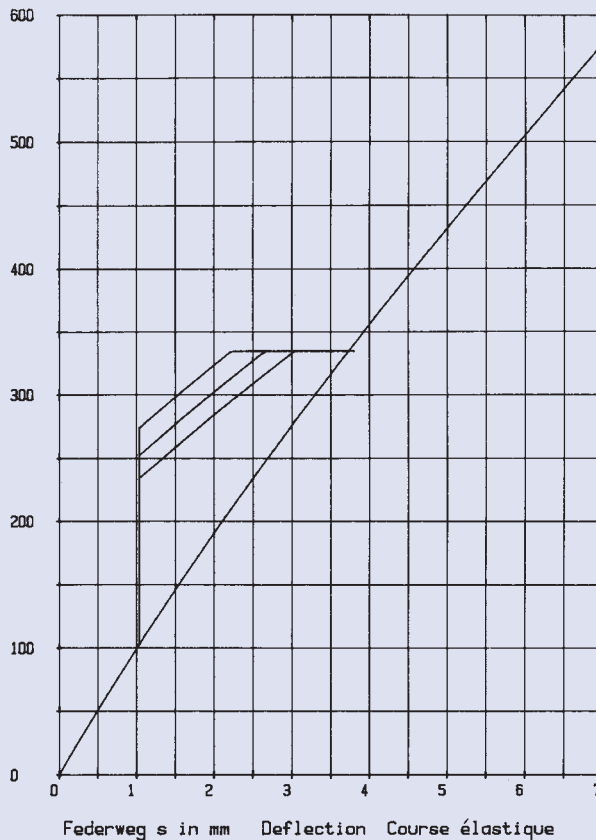
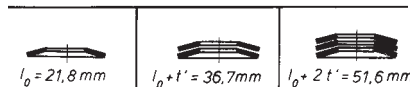



Mubea Disc Springs . 6800 Industrial Road Florence . KY 41042 USA  
Phone: (859) 746-2155 . [discspringsales@mubeausa.com](mailto:discspringsales@mubeausa.com) . [www.mubea-discsprings.com](http://www.mubea-discsprings.com)

# Mubea